

# Oracle® Data Guard

## Concepts and Administration



19c  
E96244-04  
February 2021

The Oracle logo, consisting of a solid red square with the word "ORACLE" in white, uppercase, sans-serif font centered within it.

ORACLE®

Oracle Data Guard Concepts and Administration, 19c

E96244-04

Copyright © 1999, 2021, Oracle and/or its affiliates.

Primary Authors: Padmaja Potineni, Kathy Rich

Contributors: Andy Adams, Beldalker Anand, Chipper Brown, Larry Carpenter, Jin-Jwei Chen, Laurence Clarke, Jeff Detjen, Ray Dutcher, David Gagne, B.G. Garin, Mahesh Girkar, Yuhong Gu, Joydip Kundu, Steven Lee, Steven Lim, Nitin Karkhanis, Goutam Kulkarni, Jonghyun Lee, Yunrui Li, Shashi Mangalat, Steven McGee, Bob McGuirk, Joe Meeks, Steve Moriarty, Muthu Olagappan, Ashish Ray, Mike Schloss, Mike Smith, Lawrence To, Stephen Vivian, Doug Voss, Hongjie Yang

This software and related documentation are provided under a license agreement containing restrictions on use and disclosure and are protected by intellectual property laws. Except as expressly permitted in your license agreement or allowed by law, you may not use, copy, reproduce, translate, broadcast, modify, license, transmit, distribute, exhibit, perform, publish, or display any part, in any form, or by any means. Reverse engineering, disassembly, or decompilation of this software, unless required by law for interoperability, is prohibited.

The information contained herein is subject to change without notice and is not warranted to be error-free. If you find any errors, please report them to us in writing.

If this is software or related documentation that is delivered to the U.S. Government or anyone licensing it on behalf of the U.S. Government, then the following notice is applicable:

U.S. GOVERNMENT END USERS: Oracle programs (including any operating system, integrated software, any programs embedded, installed or activated on delivered hardware, and modifications of such programs) and Oracle computer documentation or other Oracle data delivered to or accessed by U.S. Government end users are "commercial computer software" or "commercial computer software documentation" pursuant to the applicable Federal Acquisition Regulation and agency-specific supplemental regulations. As such, the use, reproduction, duplication, release, display, disclosure, modification, preparation of derivative works, and/or adaptation of i) Oracle programs (including any operating system, integrated software, any programs embedded, installed or activated on delivered hardware, and modifications of such programs), ii) Oracle computer documentation and/or iii) other Oracle data, is subject to the rights and limitations specified in the license contained in the applicable contract. The terms governing the U.S. Government's use of Oracle cloud services are defined by the applicable contract for such services. No other rights are granted to the U.S. Government.

This software or hardware is developed for general use in a variety of information management applications. It is not developed or intended for use in any inherently dangerous applications, including applications that may create a risk of personal injury. If you use this software or hardware in dangerous applications, then you shall be responsible to take all appropriate fail-safe, backup, redundancy, and other measures to ensure its safe use. Oracle Corporation and its affiliates disclaim any liability for any damages caused by use of this software or hardware in dangerous applications.

Oracle and Java are registered trademarks of Oracle and/or its affiliates. Other names may be trademarks of their respective owners.

Intel and Intel Inside are trademarks or registered trademarks of Intel Corporation. All SPARC trademarks are used under license and are trademarks or registered trademarks of SPARC International, Inc. AMD, Epyc, and the AMD logo are trademarks or registered trademarks of Advanced Micro Devices. UNIX is a registered trademark of The Open Group.

This software or hardware and documentation may provide access to or information about content, products, and services from third parties. Oracle Corporation and its affiliates are not responsible for and expressly disclaim all warranties of any kind with respect to third-party content, products, and services unless otherwise set forth in an applicable agreement between you and Oracle. Oracle Corporation and its affiliates will not be responsible for any loss, costs, or damages incurred due to your access to or use of third-party content, products, or services, except as set forth in an applicable agreement between you and Oracle.

# Contents

## Preface

---

Audience	xxii
Documentation Accessibility	xxii
Related Documents	xxii
Conventions	xxiii

## Changes in This Release for Oracle Data Guard Concepts and Administration

---

Changes in Oracle Database Release 19c	xxiv
Changes in Oracle Database Release 18c, Version 18.1	xxiv

## Part I Concepts and Administration

---

### 1 Introduction to Oracle Data Guard

---

1.1 Oracle Data Guard Configurations	1-1
1.1.1 Primary Database	1-2
1.1.2 Standby Databases	1-2
1.1.3 Far Sync Instances	1-3
1.1.4 Zero Data Loss Recovery Appliance	1-4
1.1.5 Configuration Example	1-4
1.2 Oracle Data Guard Services	1-4
1.2.1 Redo Transport Services	1-5
1.2.2 Apply Services	1-5
1.2.3 Role Transitions	1-6
1.3 Oracle Data Guard Broker	1-7
1.3.1 Using Oracle Enterprise Manager Cloud Control	1-8
1.3.2 Using the Oracle Data Guard Command-Line Interface	1-8
1.4 Oracle Data Guard Protection Modes	1-8
1.5 Client Failover	1-9
1.5.1 Application Continuity	1-10

1.6	Oracle Data Guard and Complementary Technologies	1-10
1.7	Oracle Active Data Guard Supports Oracle Sharding	1-12
1.8	Summary of Oracle Data Guard Benefits	1-16

## 2 Getting Started with Oracle Data Guard

---

2.1	Standby Database Types	2-1
2.1.1	Physical Standby Databases	2-1
2.1.2	Logical Standby Databases	2-2
2.1.3	Snapshot Standby Databases	2-3
2.2	User Interfaces for Administering Oracle Data Guard Configurations	2-4
2.3	Oracle Data Guard Operational Prerequisites	2-5
2.3.1	Hardware and Operating System Requirements	2-5
2.3.2	Oracle Software Requirements	2-5
2.4	Standby Database Directory Structure Considerations	2-7
2.5	Moving the Location of Online Data Files	2-10
2.5.1	Restrictions When Moving the Location of Online Data Files	2-10

## 3 Creating a Physical Standby Database

---

3.1	Preparing the Primary Database for Standby Database Creation	3-2
3.1.1	Enable an Appropriate Logging Mode	3-2
3.1.2	Configure Redo Transport Authentication	3-3
3.1.3	Configure the Primary Database to Receive Redo Data	3-4
3.1.4	Set Primary Database Initialization Parameters	3-5
3.1.5	Enable Archiving	3-7
3.2	Step-by-Step Instructions for Creating a Physical Standby Database	3-7
3.2.1	Creating a Physical Standby Task 1: Create a Backup Copy of the Primary Database Data Files	3-8
3.2.2	Creating a Physical Standby Task 2: Create a Control File for the Standby Database	3-8
3.2.3	Creating a Physical Standby Task 3: Create a Parameter File for the Standby Database	3-9
3.2.4	Creating a Physical Standby Task 4: Copy Files from the Primary System to the Standby System	3-11
3.2.5	Creating a Physical Standby Task 5: Set Up the Environment to Support the Standby Database	3-11
3.2.6	Creating a Physical Standby Task 6: Start the Physical Standby Database	3-12
3.2.7	Creating a Physical Standby Task 7: Verify the Physical Standby Database Is Performing Properly	3-13
3.3	Creating a Physical Standby: Post-Creation Steps	3-13
3.4	Using DBCA to Create a Data Guard Standby	3-14

3.5	Creating a Physical Standby of a CDB	3-16
3.6	Creating a PDB in a Primary Database	3-17

## 4 Creating a Logical Standby Database

---

4.1	Prerequisite Conditions for Creating a Logical Standby Database	4-1
4.1.1	Determine Support for Data Types and Storage Attributes for Tables	4-2
4.1.2	Ensure Table Rows in the Primary Database Can Be Uniquely Identified	4-2
4.2	Step-by-Step Instructions for Creating a Logical Standby Database	4-4
4.2.1	Creating a Logical Standby Task 1: Create a Physical Standby Database	4-4
4.2.2	Creating a Logical Standby Task 2: Stop Redo Apply on the Physical Standby Database	4-4
4.2.3	Creating a Logical Standby Task 3: Prepare the Primary Database to Support a Logical Standby Database	4-4
4.2.3.1	Prepare the Primary Database for Role Transitions	4-5
4.2.3.2	Build a Dictionary in the Redo Data	4-6
4.2.4	Creating a Logical Standby Task 4: Transition to a Logical Standby Database	4-7
4.2.4.1	Convert to a Logical Standby Database	4-7
4.2.4.2	Adjust Initialization Parameters for the Logical Standby Database	4-8
4.2.5	Creating a Logical Standby Task 5: Open the Logical Standby Database	4-10
4.2.6	Creating a Logical Standby Task 6: Verify the Logical Standby Database Is Performing Properly	4-12
4.3	Creating a Logical Standby: Post-Creation Steps	4-12
4.4	Creating a Logical Standby of a CDB	4-13

## 5 Using Far Sync Instances

---

5.1	Creating a Far Sync Instance	5-2
5.1.1	Creating and Configuring a Far Sync Instance	5-2
5.2	Alternate Destinations	5-5
5.2.1	Assigning Log Archive Destinations to a Group	5-6
5.2.2	Assigning Priorities to Log Archive Destinations in a Group	5-7
5.2.3	Shipping to Multiple Active Destinations in a Group	5-8
5.2.4	Using Multiple Log Archive Destination Groups	5-8
5.2.5	Determining the Availability Status of Log Archive Destinations	5-9
5.3	Configuring Alternate Destinations	5-9
5.3.1	Reduced Protection After a Far Sync Failure	5-10
5.3.2	Far Sync Instance High Availability	5-11
5.3.3	Maintaining Protection After a Role Change	5-12
5.4	Supported Protection Modes for Far Sync Instances	5-13
5.4.1	Far Sync Instances in Maximum Availability Mode Configurations	5-14

## 6 Oracle Data Guard Protection Modes

---

6.1	Oracle Data Guard Protection Modes	6-1
6.2	Setting the Data Protection Mode of a Primary Database	6-3

## 7 Redo Transport Services

---

7.1	Introduction to Redo Transport Services	7-1
7.2	Configuring Redo Transport Services	7-2
7.2.1	Redo Transport Security	7-2
7.2.1.1	Redo Transport Authentication Using SSL	7-3
7.2.1.2	Redo Transport Authentication Using a Password File	7-3
7.2.2	Configuring an Oracle Database to Send Redo Data	7-4
7.2.2.1	Viewing Attributes With V\$ARCHIVE_DEST	7-7
7.2.3	Configuring an Oracle Database to Receive Redo Data	7-7
7.2.3.1	Managing Standby Redo Logs	7-7
7.2.3.2	Cases Where Redo Is Written Directly To an Archived Redo Log File	7-8
7.3	Cascaded Redo Transport Destinations	7-8
7.3.1	Configuring a Terminal Destination	7-9
7.3.2	Cascading Scenarios	7-10
7.3.2.1	Cascading to a Physical Standby	7-11
7.3.2.2	Cascading to Multiple Physical Standbys	7-11
7.4	Data Protection Considerations for Cascading Standbys	7-11
7.5	Validating a Configuration	7-12
7.6	Monitoring Redo Transport Services	7-12
7.6.1	Monitoring Redo Transport Status	7-12
7.6.2	Monitoring Synchronous Redo Transport Response Time	7-13
7.6.3	Redo Gap Detection and Resolution	7-14
7.6.3.1	Manual Gap Resolution	7-14
7.6.4	Redo Transport Services Wait Events	7-17
7.7	Tuning Redo Transport	7-17

## 8 Apply Services

---

8.1	Introduction to Apply Services	8-1
8.2	Apply Services Configuration Options	8-1
8.2.1	Using Real-Time Apply to Apply Redo Data Immediately	8-2
8.2.2	Specifying a Time Delay for the Application of Archived Redo Log Files	8-3

8.2.2.1	Using Flashback Database as an Alternative to Setting a Time Delay	8-4
8.3	Applying Redo Data to Physical Standby Databases	8-4
8.3.1	Starting Redo Apply	8-5
8.3.2	Stopping Redo Apply	8-5
8.3.3	Monitoring Redo Apply on Physical Standby Databases	8-5
8.4	Applying Redo Data to Logical Standby Databases	8-5
8.4.1	Starting SQL Apply	8-6
8.4.2	Stopping SQL Apply on a Logical Standby Database	8-6
8.4.3	Monitoring SQL Apply on Logical Standby Databases	8-6
8.5	Standby Considerations When Removing or Renaming a PDB at a Primary	8-6

## 9 Role Transitions

---

9.1	Introduction to Role Transitions	9-2
9.1.1	Preparing for a Role Transition	9-2
9.1.2	Choosing a Target Standby Database for a Role Transition	9-3
9.1.3	Switchovers	9-4
9.1.4	Failovers	9-7
9.1.5	Role Transition Triggers	9-8
9.2	Role Transitions Involving Physical Standby Databases	9-9
9.2.1	Performing a Switchover to a Physical Standby Database	9-10
9.2.2	Performing a Failover to a Physical Standby Database	9-13
9.3	Role Transitions Involving Logical Standby Databases	9-16
9.3.1	Performing a Switchover to a Logical Standby Database	9-16
9.3.2	Performing a Failover to a Logical Standby Database	9-19
9.4	Using Flashback Database After a Role Transition	9-21
9.4.1	Using Flashback Database After a Switchover	9-21
9.4.2	Using Flashback Database After a Failover	9-21

## 10 Managing Physical and Snapshot Standby Databases

---

10.1	Starting Up and Shutting Down a Physical Standby Database	10-1
10.1.1	Starting Up a Physical Standby Database	10-1
10.1.2	Shutting Down a Physical Standby Database	10-2
10.2	Opening a Physical Standby Database	10-2
10.2.1	Real-time Query	10-3
10.2.1.1	Monitoring Apply Lag in a Real-time Query Environment	10-4
10.2.1.2	Configuring Apply Lag Tolerance in a Real-time Query Environment	10-4
10.2.1.3	Forcing Redo Apply Synchronization in a Real-time Query Environment	10-5

10.2.1.4	Real-time Query Restrictions	10-5
10.2.1.5	Automatic Block Media Recovery	10-6
10.2.1.6	Manual Block Media Recovery	10-7
10.2.1.7	Tuning Queries on a Physical Standby Database	10-7
10.2.1.8	Adding Temp Files to a Physical Standby	10-8
10.2.2	Using SQL and PL/SQL on Active Data Guard Standbys	10-8
10.2.2.1	Performing DML Operations on Active Data Guard Standby Databases	10-9
10.2.2.2	Running Top-level PL/SQL Operations on Active Data Guard Standby Databases	10-10
10.2.2.3	Automatic Recompilation of Modified PL/SQL Objects	10-10
10.2.3	Using Temporary Tables on Active Data Guard Instances	10-11
10.2.3.1	Global Temporary Tables on Active Data Guard Instances	10-11
10.2.3.2	Private Temporary Tables on Active Data Guard Instances	10-13
10.2.4	IM Column Store in an Active Data Guard Environment	10-13
10.2.5	In-Memory External Tables in an Active Data Guard Environment	10-14
10.2.6	Using Sequences in Oracle Active Data Guard	10-14
10.2.6.1	Session Sequences	10-16
10.3	Primary Database Changes That Require Manual Intervention at a Physical Standby	10-18
10.3.1	Adding a Data File or Creating a Tablespace	10-19
10.3.2	Dropping Tablespaces and Deleting Data Files	10-19
10.3.2.1	Using DROP TABLESPACE INCLUDING CONTENTS AND DATAFILES	10-20
10.3.3	Using Transportable Tablespaces with a Physical Standby Database	10-20
10.3.4	Renaming a Data File in the Primary Database	10-21
10.3.5	Add or Drop a Redo Log File Group	10-22
10.3.6	NOLOGGING or Unrecoverable Operations	10-23
10.3.7	Refresh the Password File	10-23
10.3.8	Reset the TDE Master Encryption Key	10-23
10.4	Recovering Through the OPEN RESETLOGS Statement	10-24
10.5	Automatic Flashback of a Mounted Standby After a Primary RESETLOGS Operation	10-25
10.6	Monitoring Primary, Physical Standby, and Snapshot Standby Databases	10-26
10.6.1	Using Views to Monitor Primary, Physical, and Snapshot Standby Databases	10-27
10.6.1.1	V\$DATABASE	10-28
10.6.1.2	V\$DATAGUARD_PROCESS	10-28
10.6.1.3	V\$MANAGED_STANDBY	10-29
10.6.1.4	V\$ARCHIVED_LOG	10-29
10.6.1.5	V\$LOG_HISTORY	10-29
10.6.1.6	V\$DATAGUARD_STATUS	10-30
10.6.1.7	V\$ARCHIVE_DEST	10-30



10.7	Replicating Restore Points from Primary to Standby	10-30
10.8	Tuning Redo Apply	10-31
10.9	Tuning Databases in an Active Data Guard Environment with SQL Tuning Advisor	10-31
10.10	Using Oracle Diagnostic Pack to Tune Oracle Active Data Guard Standbys	10-32
10.11	Managing a Snapshot Standby Database	10-32
10.11.1	Converting a Physical Standby Database into a Snapshot Standby Database	10-33
10.11.2	Using a Snapshot Standby Database	10-33
10.11.3	Converting a Snapshot Standby Database into a Physical Standby Database	10-34

## 11 Managing a Logical Standby Database

---

11.1	Overview of the SQL Apply Architecture	11-1
11.1.1	Various Considerations for SQL Apply	11-2
11.1.1.1	Transaction Size Considerations	11-3
11.1.1.2	Pageout Considerations	11-3
11.1.1.3	Restart Considerations	11-4
11.1.1.4	DML Apply Considerations	11-4
11.1.1.5	DDL Apply Considerations	11-4
11.1.1.6	Password Verification Functions	11-6
11.2	Controlling User Access to Tables in a Logical Standby Database	11-6
11.3	Views Related to Managing and Monitoring a Logical Standby Database	11-7
11.3.1	DBA_LOGSTDBY_EVENTS View	11-7
11.3.2	DBA_LOGSTDBY_LOG View	11-8
11.3.3	V\$DATAGUARD_STATS View	11-9
11.3.4	V\$LOGSTDBY_PROCESS View	11-9
11.3.5	V\$LOGSTDBY_PROGRESS View	11-10
11.3.6	V\$LOGSTDBY_STATE View	11-12
11.3.7	V\$LOGSTDBY_STATS View	11-12
11.4	Monitoring a Logical Standby Database	11-13
11.4.1	Monitoring SQL Apply Progress	11-13
11.4.2	Automatic Deletion of Log Files	11-16
11.5	Customizing a Logical Standby Database	11-17
11.5.1	Customizing Logging of Events in the DBA_LOGSTDBY_EVENTS View	11-18
11.5.2	Using DBMS_LOGSTDBY.SKIP to Prevent Changes to Specific Schema Objects	11-19
11.5.3	Setting up a Skip Handler for a DDL Statement	11-19
11.5.4	Modifying a Logical Standby Database	11-20
11.5.4.1	Performing DDL on a Logical Standby Database	11-21
11.5.4.2	Modifying Tables That Are Not Maintained by SQL Apply	11-21

11.5.5	Adding or Re-Creating Tables On a Logical Standby Database	11-23
11.6	Managing Specific Workloads In the Context of a Logical Standby Database	11-24
11.6.1	Importing a Transportable Tablespace to the Primary Database	11-24
11.6.2	Using Materialized Views	11-25
11.6.3	How Triggers and Constraints Are Handled on a Logical Standby Database	11-26
11.6.4	Using Triggers to Replicate Unsupported Tables	11-26
11.6.5	Recovering Through the Point-in-Time Recovery Performed at the Primary	11-29
11.6.6	Running an Oracle Streams Capture Process on a Logical Standby Database	11-29
11.7	Tuning a Logical Standby Database	11-30
11.7.1	Create a Primary Key RELY Constraint	11-31
11.7.2	Gather Statistics for the Cost-Based Optimizer	11-32
11.7.3	Adjust the Number of Processes	11-32
11.7.3.1	Adjusting the Number of APPLIER Processes	11-33
11.7.3.2	Adjusting the Number of PREPARER Processes	11-34
11.7.4	Adjust the Memory Used for LCR Cache	11-35
11.7.5	Adjust How Transactions are Applied On the Logical Standby Database	11-36
11.8	Backup and Recovery in the Context of a Logical Standby Database	11-37

## 12 Using RMAN to Back Up and Restore Files

---

12.1	About RMAN File Management in an Oracle Data Guard Configuration	12-2
12.1.1	Interchangeability of Backups in an Oracle Data Guard Environment	12-2
12.1.2	Association of Backups in an Oracle Data Guard Environment	12-2
12.1.3	Accessibility of Backups in an Oracle Data Guard Environment	12-3
12.2	About RMAN Configuration in an Oracle Data Guard Environment	12-3
12.3	Recommended RMAN and Oracle Database Configurations	12-4
12.3.1	Oracle Database Configurations on Primary and Standby Databases	12-5
12.3.2	RMAN Configurations at the Primary Database	12-6
12.3.3	RMAN Configurations at a Standby Database Where Backups are Performed	12-7
12.3.4	RMAN Configurations at a Standby Where Backups Are Not Performed	12-7
12.4	Backup Procedures	12-8
12.4.1	Using Disk as Cache for Tape Backups	12-8
12.4.1.1	Commands for Daily Tape Backups Using Disk as Cache	12-9
12.4.1.2	Commands for Weekly Tape Backups Using Disk as Cache	12-10
12.4.2	Performing Backups Directly to Tape	12-10
12.4.2.1	Commands for Daily Backups Directly to Tape	12-11
12.4.2.2	Commands for Weekly Backups Directly to Tape	12-11
12.5	Registering and Unregistering Databases in an Oracle Data Guard Environment	12-12

12.6	Reporting in an Oracle Data Guard Environment	12-12
12.7	Performing Backup Maintenance in an Oracle Data Guard Environment	12-12
12.7.1	Changing Metadata in the Recovery Catalog	12-13
12.7.2	Deleting Archived Logs or Backups	12-14
12.7.3	Validating Recovery Catalog Metadata	12-14
12.8	Recovery Scenarios in an Oracle Data Guard Environment	12-15
12.8.1	Recovery from Loss of Files on the Primary or Standby Database	12-15
12.8.2	Recovery from Loss of Online Redo Log Files	12-16
12.8.3	Incomplete Recovery of the Primary Database	12-16
12.8.4	Actions Needed on Standby After TSPITR or Tablespace Plugin at Primary	12-18
12.9	Additional Backup Situations	12-18
12.9.1	Standby Databases Too Geographically Distant to Share Backups	12-18
12.9.2	Standby Database Does Not Contain Data Files, Used as a FAL Server	12-19
12.9.3	Standby Database File Names Are Different From Primary Database	12-19
12.10	Restoring and Recovering Files Over the Network	12-20
12.11	Rolling Forward a Standby With One Command	12-21
12.12	RMAN Support for CDBs In an Oracle Data Guard Environment	12-21

## 13 Using SQL Apply to Upgrade the Oracle Database

---

13.1	Benefits of a Rolling Upgrade Using SQL Apply	13-1
13.2	Requirements to Perform a Rolling Upgrade Using SQL Apply	13-2
13.3	Figures and Conventions Used in the Upgrade Instructions	13-2
13.4	Performing a Rolling Upgrade By Creating a New Logical Standby Database	13-3
13.5	Performing a Rolling Upgrade With an Existing Logical Standby Database	13-5
13.6	Performing a Rolling Upgrade With an Existing Physical Standby Database	13-11

## 14 Using DBMS\_ROLLING to Perform a Rolling Upgrade

---

14.1	Concepts New to Rolling Upgrades	14-2
14.1.1	Data Guard Broker Support for DBMS_ROLLING Upgrades	14-3
14.2	DBMS_ROLLING Upgrades and CDBs	14-5
14.3	Overview of Using DBMS_ROLLING	14-6
14.4	Planning a Rolling Upgrade	14-7
14.5	Performing a Rolling Upgrade	14-14
14.6	Monitoring a Rolling Upgrade	14-16
14.7	Rolling Back a Rolling Upgrade	14-17
14.8	Handling Role Changes That Occur During a Rolling Upgrade	14-17
14.9	Examples of Rolling Upgrades	14-18

## 15 Oracle Data Guard Scenarios

---

15.1	Configuring Logical Standby Databases After a Failover	15-1
15.1.1	When the New Primary Database Was Formerly a Physical Standby Database	15-1
15.1.2	When the New Primary Database Was Formerly a Logical Standby Database	15-2
15.2	Converting a Failed Primary Into a Standby Database Using Flashback Database	15-4
15.2.1	Flashing Back a Failed Primary Database into a Physical Standby Database	15-4
15.2.2	Flashing Back a Failed Primary Database into a Logical Standby Database	15-5
15.2.3	Flashing Back a Logical Standby Database to a Specific Applied SCN	15-7
15.3	Using Flashback Database After Issuing an Open Resetlogs Statement	15-7
15.3.1	Flashing Back a Physical Standby Database to a Specific Point-in-Time	15-7
15.3.2	Flashing Back a Logical Standby Database to a Specific Point-in-Time	15-8
15.4	Recovering After the NOLOGGING Clause Is Specified	15-9
15.4.1	Recovery Steps for Logical Standby Databases	15-10
15.4.2	Recovery Steps for Physical Standby Databases	15-10
15.4.3	Determining If a Backup Is Required After Unrecoverable Operations	15-12
15.4.4	Recovery Steps for Part of a Physical Standby Database	15-12
15.5	Creating a Standby Database That Uses OMF or Oracle ASM	15-13
15.6	Recovering From Lost-Write Errors on a Primary Database	15-15
15.7	Using the DBCOMP Procedure to Detect Lost Writes and Other Inconsistencies	15-18
15.8	Converting a Failed Primary into a Standby Database Using RMAN Backups	15-19
15.8.1	Converting a Failed Primary into a Physical Standby Using RMAN Backups	15-20
15.8.2	Converting a Failed Primary into a Logical Standby Using RMAN Backups	15-22
15.9	Changing the Character Set of a Primary Without Re-Creating Physical Standbys	15-23
15.10	Actions Needed On a Standby After a PDB PITR or PDB Flashback On a Primary	15-24

## Part II Reference

---

### 16 Initialization Parameters

---

## 17 LOG\_ARCHIVE\_DEST\_n Parameter Attributes

---

17.1	AFFIRM and NOAFFIRM	17-2
17.2	ALTERNATE	17-3
17.3	COMPRESSION	17-5
17.4	DB_UNIQUE_NAME	17-6
17.5	DELAY	17-7
17.6	ENCRYPTION	17-9
17.7	GROUP	17-10
17.8	LOCATION and SERVICE	17-11
17.9	MANDATORY	17-12
17.10	MAX_FAILURE	17-13
17.11	NET_TIMEOUT	17-15
17.12	NOREGISTER	17-16
17.13	PRIORITY	17-17
17.14	REOPEN	17-18
17.15	SYNC and ASYNC	17-19
17.16	TEMPLATE	17-20
17.17	VALID_FOR	17-21

## 18 SQL Statements Relevant to Oracle Data Guard

---

18.1	ALTER DATABASE Statements	18-1
18.2	ALTER SESSION Statements	18-4
18.3	ALTER SYSTEM Statements	18-5

## 19 Views Relevant to Oracle Data Guard

---

## Part III Appendixes

---

### A Troubleshooting Oracle Data Guard

---

A.1	Common Problems	A-1
A.1.1	Renaming Data Files with the ALTER DATABASE Statement	A-1
A.1.2	Standby Database Does Not Receive Redo Data from the Primary Database	A-2
A.1.3	You Cannot Mount the Physical Standby Database	A-3
A.2	Log File Destination Failures	A-3
A.3	Handling Logical Standby Database Failures	A-3
A.4	Problems Switching Over to a Physical Standby Database	A-4

A.4.1	Switchover Fails Because Redo Data Was Not Transmitted	A-4
A.4.2	Switchover Fails with the ORA-01102 Error	A-5
A.4.3	Redo Data Is Not Applied After Switchover	A-5
A.4.4	Roll Back After Unsuccessful Switchover and Start Over	A-6
A.5	Problems Switching Over to a Logical Standby Database	A-7
A.5.1	Failures During the Prepare Phase of a Switchover Operation	A-7
A.5.1.1	Failure While Preparing the Primary Database	A-7
A.5.1.2	Failure While Preparing the Logical Standby Database	A-8
A.5.2	Failures During the Commit Phase of a Switchover Operation	A-8
A.5.2.1	Failure to Convert the Original Primary Database	A-8
A.5.2.2	Failure to Convert the Target Logical Standby Database	A-9
A.6	What to Do If SQL Apply Stops	A-10
A.7	Network Tuning for Redo Data Transmission	A-11
A.8	Slow Disk Performance on Standby Databases	A-12
A.9	Log Files Must Match to Avoid Primary Database Shutdown	A-12
A.10	Troubleshooting a Logical Standby Database	A-12
A.10.1	Recovering from Errors	A-12
A.10.1.1	DDL Transactions Containing File Specifications	A-13
A.10.1.2	Recovering from DML Failures	A-14
A.10.2	Troubleshooting SQL*Loader Sessions	A-14
A.10.3	Troubleshooting Long-Running Transactions	A-16
A.10.4	Troubleshooting ORA-1403 Errors with Flashback Transactions	A-19

## **B** Patching, Upgrading, and Downgrading Databases in an Oracle Data Guard Configuration

---

B.1	Before You Patch or Upgrade the Oracle Database Software	B-1
B.2	Patching Oracle Database with Standby First Patching	B-2
B.3	Upgrading Oracle Database with a Physical Standby Database in Place	B-3
B.4	Upgrading Oracle Database with a Logical Standby Database in Place	B-4
B.5	Modifying the COMPATIBLE Initialization Parameter After Upgrading	B-5
B.6	Downgrading Oracle Database with No Logical Standby in Place	B-6
B.7	Downgrading Oracle Database with a Logical Standby in Place	B-7

## **C** Data Type and DDL Support on a Logical Standby Database

---

C.1	Datatype Considerations	C-1
C.1.1	Supported Datatypes in a Logical Standby Database	C-2
C.1.1.1	Compatibility Requirements	C-3
C.1.1.2	Opaque Type Restrictions	C-4
C.1.2	Unsupported Datatypes in a Logical Standby Database	C-4

C.2	Support for Data Types That Lack Native Redo-Based Support	C-4
C.3	Support for Transparent Data Encryption (TDE)	C-5
C.4	Support for Tablespace Encryption	C-5
C.5	Support For Row-level Security and Fine-Grained Auditing	C-6
C.5.1	Row-level Security	C-6
C.5.2	Fine-Grained Auditing	C-7
C.5.3	Skipping and Enabling PL/SQL Replication	C-7
C.6	Oracle Label Security	C-8
C.7	Oracle Database Vault	C-8
C.8	Oracle E-Business Suite	C-8
C.9	Supported Table Storage Types	C-8
C.10	Unsupported Table Storage Types	C-9
C.10.1	Unsupported Tables as a Result of Partitioning	C-10
C.11	PL/SQL Supplied Packages Considerations	C-10
C.11.1	Supported PL/SQL Supplied Packages	C-10
C.11.2	Unsupported PL/SQL Supplied Packages	C-11
C.11.2.1	Support for DBMS_JOB	C-11
C.11.2.2	Support for DBMS_SCHEDULER	C-11
C.11.3	Handling XML and XDB PL/SQL Packages in Logical Standby	C-12
C.11.3.1	The DBMS_XMLSCHEMA Schema	C-13
C.11.3.2	The DBMS_XMLINDEX Package	C-13
C.11.3.3	Dealing With Unsupported PL/SQL Procedures	C-13
C.11.3.4	Manually Compensating for Unsupported PL/SQL	C-13
C.11.3.5	Compensating for Ordering Sensitive Unsupported PL/SQL	C-14
C.12	Unsupported Tables	C-16
C.12.1	Unsupported Tables During Rolling Upgrades	C-18
C.12.2	Unsupported Tables As a Result of DML Performed In a PL/SQL Function	C-19
C.13	Skipped SQL Statements on a Logical Standby Database	C-19
C.14	DDL Statements Supported by a Logical Standby Database	C-20
C.14.1	DDL Statements that Use DBLINKS	C-23
C.14.2	Replication of AUD\$ and FGA_LOG\$ on Logical Standbys	C-24
C.15	Distributed Transactions and XA Support	C-24
C.16	Support for SecureFiles LOBs	C-25
C.17	Support for Database File System (DBFS)	C-25
C.18	Character Set Considerations	C-25
C.19	Additional PL/SQL Package Support Available Only in the Context of DBMS_ROLLING Upgrades	C-25

## D Oracle Data Guard and Oracle Real Application Clusters

---

D.1	Configuring Standby Databases in an Oracle RAC Environment	D-1
-----	--	-----

D.1.1	Setting Up Multi-Instance Redo Apply	D-1
D.1.2	Setting Up a Multi-Instance Primary with a Single-Instance Standby	D-2
D.1.3	Setting Up Oracle RAC Primary and Standby Databases	D-3
D.1.3.1	Configuring an Oracle RAC Standby Database to Receive Redo Data	D-3
D.1.3.2	Configuring an Oracle RAC Primary Database to Send Redo Data	D-4
D.2	Configuration Considerations in an Oracle RAC Environment	D-4
D.2.1	Format for Archived Redo Log Filenames	D-4
D.2.2	Data Protection Modes	D-5

## E Creating a Standby Database with Recovery Manager

---

E.1	Prerequisites	E-1
E.2	Overview of Standby Database Creation with RMAN	E-1
E.2.1	Purpose of Standby Database Creation with RMAN	E-1
E.2.2	Basic Concepts of Standby Creation with RMAN	E-2
E.2.2.1	Active Database and Backup-Based Duplication	E-2
E.2.2.2	DB_UNIQUE_NAME Values in an RMAN Environment	E-2
E.2.2.3	Recovery of a Standby Database	E-3
E.2.2.4	Password Files for the Standby Database	E-4
E.3	Using the DUPLICATE Command to Create a Standby Database	E-4
E.3.1	Using Active Database Duplication to Create a Standby Database or Far Sync Instance	E-5
E.3.2	Creating a Standby Database with Backup-Based Duplication	E-7

## F Setting Archive Tracing

---

F.1	Setting the LOG_ARCHIVE_TRACE Initialization Parameter	F-1
-----	--	-----

## G Performing Role Transitions Using Old Syntax

---

G.1	SQL Syntax for Role Transitions Involving Physical Standbys	G-1
G.1.1	New Features When Using the Old Syntax	G-2
G.2	Role Transitions Involving Physical Standby Databases	G-2
G.2.1	Performing a Switchover to a Physical Standby Database Using Old Syntax	G-3
G.2.2	Performing a Failover to a Physical Standby Database Using Old Syntax	G-4
G.3	Troubleshooting Switchovers to Physical Standby Databases	G-7
G.3.1	Switchover Fails Because Redo Data Was Not Transmitted	G-7
G.3.2	Switchover Fails with the ORA-01102 Error	G-8
G.3.3	Redo Data Is Not Applied After Switchover	G-8



## H Using the ALTERNATE Attribute to Configure Remote Alternate Destinations

---

H.1 Configuring an Alternate Destination

H-1

Index

---

## List of Examples

---

3-1	Modifying Initialization Parameters for a Physical Standby Database	3-9
4-1	Primary Database: Logical Standby Role Initialization Parameters	4-5
4-2	Modifying Initialization Parameters for a Logical Standby Database	4-10
5-1	Some of the Initialization Parameters Used for Far Sync Instances	5-4
5-2	Configuring for Single Destination Failover	5-10
5-3	Configuring for Multiple Standby Database Redo Destination Failover	5-10
5-4	Parameters Used to Set Up the High Availability Far Sync Instance	5-12
5-5	Parameters Used to Set Up Protection After a Role Change	5-13
7-1	Some of the Initialization Parameters Used When Cascading Redo	7-10
10-1	Performing DML Operations on a Physical Standby Database	10-9
10-2	Automatically Recompiling Modified PL/SQL Objects	10-10
11-1	V\$DATAGUARD_STATS Contents for a Logical Standby Database	11-9
14-1	Setting Switchover to Enforce Apply Lag Requirements	14-13
14-2	Resetting Logging Back to Its Default Value	14-14
14-3	Designating a Database as an Optional Participant	14-14
14-4	Setting a Database to Protect the Transient Logical Standby	14-14
14-5	Basic Rolling Upgrade Steps	14-18
14-6	Rolling Upgrade Between Two Databases	14-19
14-7	Rolling Upgrade Between Three Databases	14-19
14-8	Rolling Upgrade Between Four Databases	14-19
14-9	Rolling Upgrade on a Reader Farm	14-19
14-10	Rolling Upgrade for Application Testing	14-20
14-11	Resuming a Rolling Upgrade After a Failover to a New Primary	14-21
14-12	Resuming a Rolling Upgrade After a Failover to a New Transient Logical	14-22
15-1	Primary and All Standbys Are Mounted or Open and DBCOMP Is Executed From the Primary	15-18
15-2	Primary and All Standbys Are Mounted or Open and DBCOMP Is Executed From a Standby	15-18
15-3	Primary Is Mounted or Open, But Not All Standbys Are, and DBCOMP is Executed From the Primary	15-19
15-4	Primary Is Mounted or Open, But Not All Standbys Are, and DBCOMP is Executed From a Standby	15-19
15-5	Primary is Not Mounted, But Multiple Standbys Are Mounted or Open	15-19
15-6	Primary Is Mounted or Open, But No Standbys Are Mounted or Open	15-19
17-1	Automatically Failing Over to an Alternate Local Destination	17-4

17-2	Automatic Local Alternate Fallback	17-5
A-1	Setting a Retry Time and Limit	A-3
A-2	Specifying an Alternate Destination	A-3
C-1	PL/SQL Skip Procedure for RegisterSchema	C-15

## List of Figures

---

1-1	Typical Oracle Data Guard Configuration	1-4
1-2	Automatic Updating of a Physical Standby Database	1-6
1-3	Automatic Updating of a Logical Standby Database	1-6
1-4	System-Managed Sharding With Oracle Data Guard Replication	1-13
1-5	Composite Sharding With Oracle Data Guard Replication	1-15
2-1	Possible Standby Configurations	2-9
8-1	Applying Redo Data to a Standby Destination Using Real-Time Apply	8-3
9-1	Oracle Data Guard Configuration Before Switchover	9-5
9-2	Standby Databases Before Switchover to the New Primary Database	9-6
9-3	Oracle Data Guard Environment After Switchover	9-6
9-4	Failover to a Standby Database	9-7
11-1	SQL Apply Processing	11-1
11-2	Progress States During SQL Apply Processing	11-14
13-1	Oracle Data Guard Configuration Before Upgrade	13-3
13-2	Upgrade the Logical Standby Database Release	13-6
13-3	Running Mixed Releases	13-6
13-4	After a Switchover	13-9
13-5	Both Databases Upgraded	13-10
D-1	Transmitting Redo Data from a Multi-Instance Primary Database	D-2

## List of Tables

---

2-1	Standby Database Location and Directory Options	2-10
3-1	Creating a Physical Standby Database	3-8
4-1	Creating a Logical Standby Database	4-4
6-1	Required Redo Transport Attributes for Data Protection Modes	6-3
7-1	LOG_ARCHIVE_DEST_STATE_n Initialization Parameter Values	7-4
7-2	Redo Transport Wait Events	7-17
10-1	Primary Database Changes That Require Manual Intervention at a Physical Standby	10-18
10-2	Sources of Information About Common Primary Database Management Actions	10-26
13-1	Steps to Perform a Rolling Upgrade by Creating a New Logical Standby	13-3
13-2	Steps to Perform a Rolling Upgrade With an Existing Logical Standby	13-5
13-3	Steps to Perform a Rolling Upgrade With an Existing Physical Standby	13-11
14-1	Trailing Group Physicals (TGP) Versus Leading Group Physicals (LGP)	14-3
14-2	Steps to Perform Rolling Upgrade Using DBMS_ROLLING	14-14
16-1	Initialization Parameters for Instances in an Oracle Data Guard Configuration	16-1
17-1	Directives for the TEMPLATE Attribute	17-20
18-1	ALTER DATABASE Statements Used in Data Guard Environments	18-1
18-2	ALTER SESSION Statements Used in Oracle Data Guard Environments	18-4
18-3	ALTER SYSTEM Statements Used in Oracle Data Guard Environments	18-5
19-1	Views That Are Pertinent to Oracle Data Guard Configurations	19-1
A-1	Fixing Typical SQL Apply Errors	A-11
C-1	Values for stmt Parameter of the DBMS_LOGSTDBY.SKIP procedure	C-20
D-1	Directives for the LOG_ARCHIVE_FORMAT Initialization Parameter	D-4

# Preface

Oracle Data Guard is the most effective solution available today to protect the core asset of any enterprise—its data, and make it available on a 24x7 basis even in the face of disasters and other calamities. This guide describes Oracle Data Guard technology and concepts, and helps you configure and implement standby databases.

## Audience

*Oracle Data Guard Concepts and Administration* is intended for database administrators (DBAs) who administer the backup, restoration, and recovery operations of an Oracle database system.

To use this document, you should be familiar with relational database concepts and basic backup and recovery administration. You should also be familiar with the operating system environment under which you are running Oracle software.

## Documentation Accessibility

For information about Oracle's commitment to accessibility, visit the Oracle Accessibility Program website at <http://www.oracle.com/pls/topic/lookup?ctx=acc&id=docacc>.

### Access to Oracle Support

Oracle customers that have purchased support have access to electronic support through My Oracle Support. For information, visit <http://www.oracle.com/pls/topic/lookup?ctx=acc&id=info> or visit <http://www.oracle.com/pls/topic/lookup?ctx=acc&id=trs> if you are hearing impaired.

## Related Documents

Readers of *Oracle Data Guard Concepts and Administration* should also read:

- The beginning of *Oracle Database Concepts*, that provides an overview of the concepts and terminology related to the Oracle database and serves as a foundation for the more detailed information in this guide.
- The chapters in the *Oracle Database Administrator's Guide* that deal with managing the control files, online redo log files, and archived redo log files.
- The chapter in the *Oracle Database Utilities* that discusses LogMiner technology.
- *Oracle Data Guard Broker* that describes the graphical user interface and command-line interface for automating and centralizing the creation, maintenance, and monitoring of Oracle Data Guard configurations.
- Oracle Enterprise Manager Cloud Control online Help system

---

## Conventions

The following text conventions are used in this document:

Convention	Meaning
<b>boldface</b>	Boldface type indicates graphical user interface elements associated with an action, or terms defined in text or the glossary.
<i>italic</i>	Italic type indicates book titles, emphasis, or placeholder variables for which you supply particular values.
monospace	Monospace type indicates commands within a paragraph, URLs, code in examples, text that appears on the screen, or text that you enter.

---

# Changes in This Release for Oracle Data Guard Concepts and Administration

This preface lists changes in *Oracle Data Guard Concepts and Administration*.

## Changes in Oracle Database Release 19c

These are the changes in *Oracle Data Guard Concepts and Administration* for Oracle Database Release 19c.

### New Features

- The process of flashing back a physical standby to a point in time that was captured on the primary is simplified by automatically replicating restore points from primary to the standby. See [Replicating Restore Points from Primary to Standby](#).
- When flashback or point-in-time recovery is performed on the primary database, a standby that is in mounted mode can automatically follow the same recovery procedure performed on the primary. See [Automatic Flashback of a Mounted Standby After a Primary RESETLOGS Operation](#).
- You can enable the Oracle Database In-Memory Column Store and Data Guard Multi-Instance Redo Apply at the same time on an Active Data Guard standby database.
- DML operations can be performed on Active Data Guard standby instances. When an invalid PL/SQL object is run on an ADG standby database, the object is automatically recompiled. See [Performing DML Operations on Active Data Guard Standby Databases](#) and [Running Top-level PL/SQL Operations on Active Data Guard Standby Databases](#).

### Desupported Features

- The `MAX_CONNECTIONS` attribute for the `LOG_ARCHIVE_DEST_n` initialization parameter is desupported.
- Extended Datatype Support (EDS) is desupported. All EDS-supported Oracle data types are now supported natively by logical standbys or Oracle GoldenGate.

## Changes in Oracle Database Release 18c, Version 18.1

These are the changes in *Oracle Data Guard Concepts and Administration* for Changes in Oracle Database Release 18c, Version 18.1.



- The database buffer cache state is now maintained on an Oracle Active Data Guard standby during a role change. See [Role Transitions Involving Physical Standby Databases](#).
- Global temporary tables can now be dynamically created on an Oracle Active Data Guard standby database. See [Global Temporary Tables on Active Data Guard Instances](#).
- A new initialization parameter, `ADG_ACCOUNT_INFO_TRACKING`, extends control of user account security against login attacks across a production database and all Oracle Active Data Guard standby databases. See *Oracle Database Reference*.
- A new view `V$DATAGUARD_PROCESS` (which replaces `V$MANAGED_STANDBY`) provides information that can be queried to verify that redo is being transmitted from the primary database and applied to the standby database. See [Creating a Physical Standby Task 7: Verify the Physical Standby Database Is Performing Properly](#).
- Metadata for private temporary tables (also known as local temporary tables) can be stored in memory. This allows private temporary tables to be enabled on read-only databases, hence allowing reporting applications to run on Oracle Active Data Guard standby databases. See [Private Temporary Tables on Active Data Guard Instances](#).
- Database nologging has been extended with two new modes: Standby Nologging for Load Performance and Standby Nologging for Data Availability. These modes provide better support for use in an Oracle Active Data Guard environment without significantly increasing the amount of redo generated. See [Enable an Appropriate Logging Mode](#).
- A standby database can now be refreshed over the network using one RMAN command, `RECOVER STANDBY DATABASE`. See [Rolling Forward a Standby With One Command](#).
- Enhancements have been made to Data Guard broker support for upgrades performed using the `DBMS_ROLLING` PL/SQL package. See [Data Guard Broker Support for DBMS\\_ROLLING Upgrades](#).
- Block Change Tracking is now supported with multi-instance redo apply. See [Setting Up Multi-Instance Redo Apply](#).

# Part I

## Concepts and Administration

The following topics provide information about Oracle Data Guard concepts and administration:

- [Introduction to Oracle Data Guard](#)
- [Getting Started with Oracle Data Guard](#)
- [Creating a Physical Standby Database](#)
- [Creating a Logical Standby Database](#)
- [Using Far Sync Instances](#)
- [Oracle Data Guard Protection Modes](#)
- [Redo Transport Services](#)
- [Apply Services](#)
- [Role Transitions](#)
- [Managing Physical and Snapshot Standby Databases](#)
- [Managing a Logical Standby Database](#)
- [Using RMAN to Back Up and Restore Files](#)
- [Using SQL Apply to Upgrade the Oracle Database](#)
- [Using DBMS\\_ROLLING to Perform a Rolling Upgrade](#)
- [Oracle Data Guard Scenarios](#)

# 1

## Introduction to Oracle Data Guard

Oracle Data Guard ensures high availability, data protection, and disaster recovery for enterprise data.

Oracle Data Guard provides a comprehensive set of services that create, maintain, manage, and monitor one or more standby databases to enable production Oracle databases to survive disasters and data corruptions. Oracle Data Guard maintains these standby databases as copies of the production database. Then, if the production database becomes unavailable because of a planned or an unplanned outage, Oracle Data Guard can switch any standby database to the production role, minimizing the downtime associated with the outage. Oracle Data Guard can be used with traditional backup, restoration, and cluster techniques to provide a high level of data protection and data availability. Oracle Data Guard transport services are also used by other Oracle features such as Oracle Streams and Oracle GoldenGate for efficient and reliable transmission of redo from a source database to one or more remote destinations.

With Oracle Data Guard, administrators can optionally improve production database performance by offloading resource-intensive backup and reporting operations to standby systems.

See the following topics which describe the highlights of Oracle Data Guard:

- [Oracle Data Guard Configurations](#)
- [Oracle Data Guard Services](#)
- [Oracle Data Guard Broker](#)
- [Oracle Data Guard Protection Modes](#)
- [Client Failover](#)
- [Oracle Data Guard and Complementary Technologies](#)
- [Oracle Active Data Guard Supports Oracle Sharding](#)
- [Summary of Oracle Data Guard Benefits](#)

### 1.1 Oracle Data Guard Configurations

An **Oracle Data Guard configuration** can contain one primary database and up to thirty destinations.

The members of an Oracle Data Guard configuration are connected by Oracle Net and may be dispersed geographically. There are no restrictions on where the members of an Oracle Data Guard configuration are located as long as they can communicate with each other. For example, you can have a standby database in the same data center as the primary database, along with two standbys in another data center.

You can manage primary and standby databases using either the SQL command-line interface or the Oracle Data Guard broker interfaces. The broker provides a command-

line interface (DGMGRL) and a graphical user interface that is integrated in Oracle Enterprise Manager Cloud Control.

## 1.1.1 Primary Database

An Oracle Data Guard configuration contains one production database, also referred to as the primary database, that functions in the primary role.

The primary database is the database that is accessed by most of your applications.

The primary database can be either a single-instance Oracle database or an Oracle Real Application Clusters (Oracle RAC) database.

## 1.1.2 Standby Databases

A standby database is a transactionally consistent copy of the primary database.

Using a backup copy of the primary database, you can create up to thirty standby databases and incorporate them into an Oracle Data Guard configuration. Oracle Data Guard automatically maintains each standby database by transmitting redo data from the primary database and then applying the redo to the standby database.

Similar to a primary database, a standby database can be either a single-instance Oracle database or an Oracle RAC database.

The types of standby databases are as follows:

- **Physical standby database**

Provides a physically identical copy of the primary database, with on-disk database structures that are identical to the primary database on a block-for-block basis. The database schema, including indexes, are the same. A physical standby database is kept synchronized with the primary database, through Redo Apply, which recovers the redo data received from the primary database and applies the redo to the physical standby database.

As of Oracle Database 11g Release 1 (11.1), a physical standby database can receive and apply redo while it is open for read-only access. A physical standby database can therefore be used concurrently for data protection and reporting.

Additionally, as of Oracle Database 11g Release 2 (11.2.0.1), a physical standby database can be used to install eligible one-off patches, patch set updates (PSUs), and critical patch updates (CPUs), in rolling fashion. For more information about this functionality, see the My Oracle Support note 1265700.1 at <http://support.oracle.com>.

- **Logical standby database**

Contains the same logical information as the production database, although the physical organization and structure of the data can be different. The logical standby database is kept synchronized with the primary database through SQL Apply, which transforms the data in the redo received from the primary database into SQL statements and then executes the SQL statements on the standby database.

The flexibility of a logical standby database lets you upgrade Oracle Database software (patch sets and new Oracle Database releases) and perform other database maintenance in rolling fashion with almost no downtime. From Oracle

Database 11g onward, the transient logical database rolling upgrade process can also be used with existing physical standby databases.

- **Snapshot Standby Database**

A snapshot standby database is a fully updatable standby database.

Like a physical or logical standby database, a snapshot standby database receives and archives redo data from a primary database. Unlike a physical or logical standby database, a snapshot standby database does not apply the redo data that it receives. The redo data received by a snapshot standby database is not applied until the snapshot standby is converted back into a physical standby database, after first discarding any local updates made to the snapshot standby database.

A snapshot standby database is best used in scenarios that require a temporary, updatable snapshot of a physical standby database. For example, you can use the Oracle Real Application Testing option to capture the database workload on a primary and then replay it for test purposes on the snapshot standby. Because redo data received by a snapshot standby database is not applied until it is converted back into a physical standby, the time needed to recover from a primary database failure is directly proportional to the amount of redo data that needs to be applied.

 **See Also:**

- *Oracle Database Testing Guide* for more information about Oracle Real Application Testing and the license required to use it

### 1.1.3 Far Sync Instances

An Oracle Data Guard far sync instance is a remote Oracle Data Guard destination that accepts redo from the primary database and then ships that redo to other members of the Oracle Data Guard configuration.

A far sync instance manages a control file, receives redo into standby redo logs (SRLs), and archives those SRLs to local archived redo logs, but that is where the similarity with standbys ends. A far sync instance does not have user data files, cannot be opened for access, cannot run redo apply, and can never function in the primary role or be converted to any type of standby database.

Far sync instances are part of the Oracle Active Data Guard Far Sync feature, which requires an Oracle Active Data Guard license.

 **See Also:**

- [Far Sync](#)

## 1.1.4 Zero Data Loss Recovery Appliance

Zero Data Loss Recovery Appliance (Recovery Appliance) is an enterprise-level backup solution that provides a single repository for backups of all of your Oracle databases.

Recovery Appliance offloads most Oracle Database backup and restore processing to a centralized backup system. It enables you to achieve significant efficiencies in storage utilization, performance, and manageability of backups.

### See Also:

- *Zero Data Loss Recovery Appliance Administrator's Guide*

## 1.1.5 Configuration Example

[Figure 1-1](#) shows a typical Oracle Data Guard configuration that contains a primary database that transmits redo data to a standby database. The standby database is remotely located from the primary database for disaster recovery and backup operations. You can configure the standby database at the same location as the primary database. However, for disaster recovery purposes, Oracle recommends you configure standby databases at remote locations.

**Figure 1-1 Typical Oracle Data Guard Configuration**

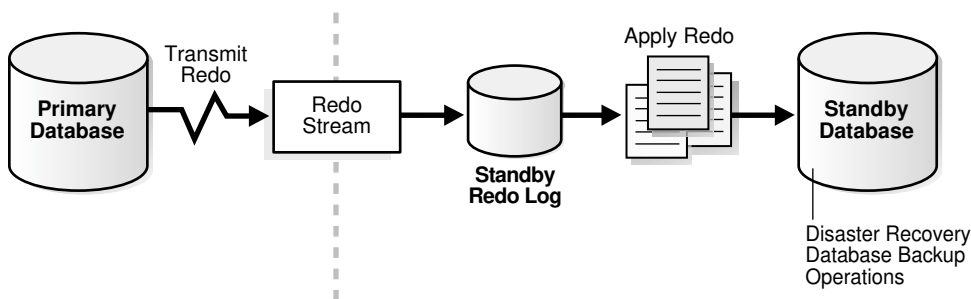

## 1.2 Oracle Data Guard Services

Oracle Data Guard uses Redo Transport Services and Apply Services to manage the transmission of redo data, the application of redo data, and changes to the database roles.

- [Redo Transport Services](#)  
Control the automated transfer of redo data from the production database to one or more archival destinations.
- [Apply Services](#)

Redo data is applied directly from standby redo log files as they are filled using real-time apply. If standby redo log files are not configured, then redo data must first be archived at the standby database before it is applied.

- [Role Transitions](#)

Change the role of a database from a standby database to a primary database, or from a primary database to a standby database using either a switchover or a failover operation.

## 1.2.1 Redo Transport Services

**Redo transport services** control the automated transfer of redo data from the production database to one or more archival destinations.

Redo transport services perform the following tasks:

- Transmit redo data from the primary system to the standby systems in the configuration
- Manage the process of resolving any gaps in the archived redo log files due to a network failure
- Automatically detect missing or corrupted archived redo log files on a standby system and automatically retrieve replacement archived redo log files from the primary database or another standby database.

## 1.2.2 Apply Services

**Apply services** automatically apply the redo data on the standby database to maintain consistency with the primary database.

The redo data is transmitted from the primary database and written to the standby redo log on the standby database. Apply services also allows read-only access to the data.

The main difference between physical and logical standby databases is the manner in which apply services apply the archived redo data:

- For physical standby databases, Oracle Data Guard uses **Redo Apply** technology, which applies redo data on the standby database using standard recovery techniques of an Oracle database, as shown in [Figure 1-2](#).

Figure 1-2 Automatic Updating of a Physical Standby Database

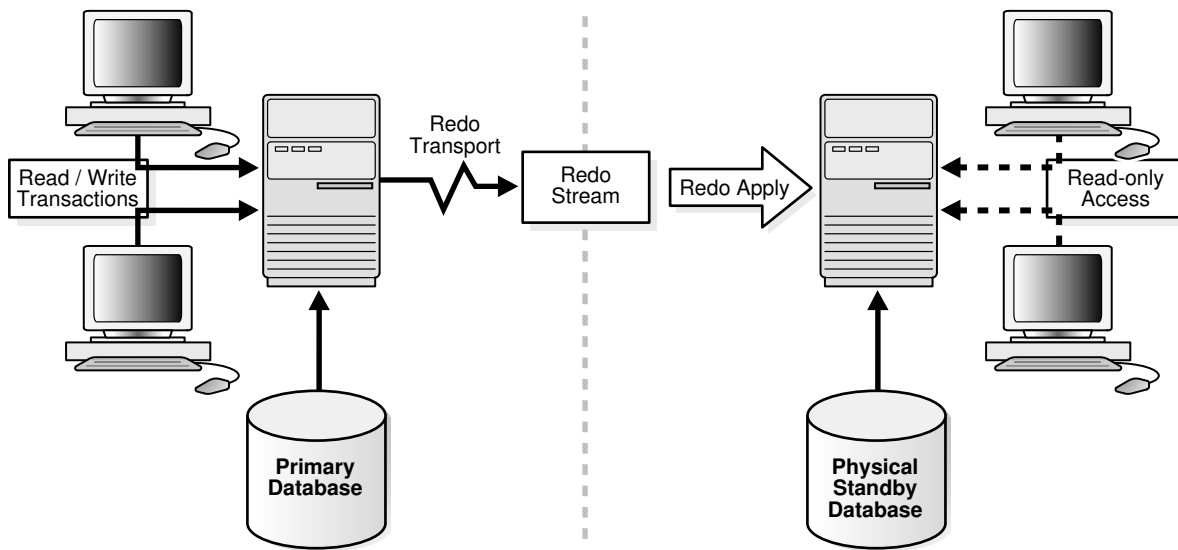

- For logical standby databases, Oracle Data Guard uses **SQL Apply** technology, which first transforms the received redo data into SQL statements and then executes the generated SQL statements on the logical standby database, as shown in Figure 1-3.

Figure 1-3 Automatic Updating of a Logical Standby Database

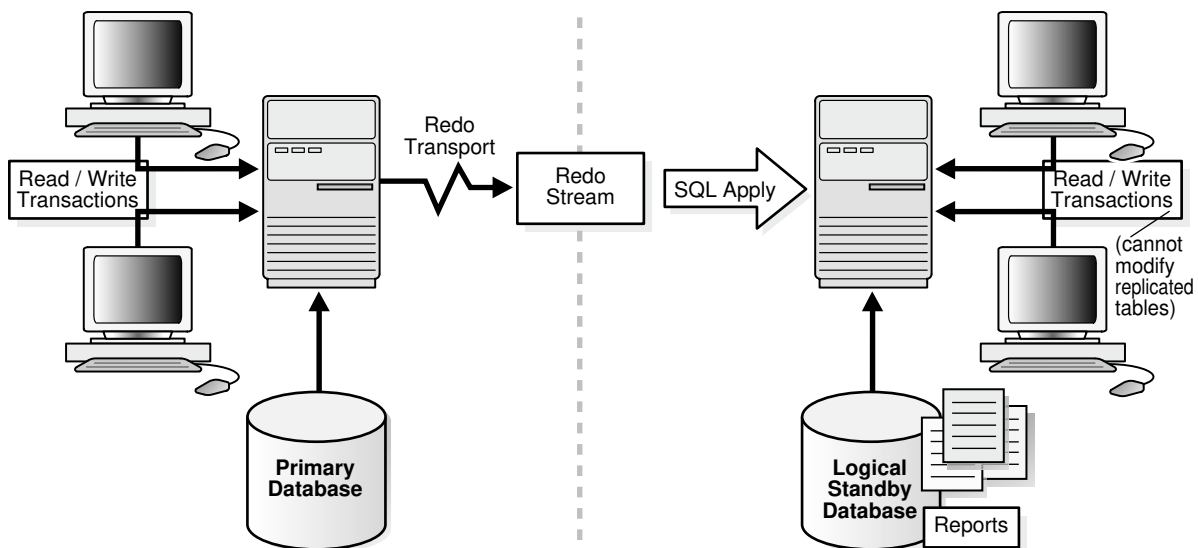

## 1.2.3 Role Transitions

Using Oracle Data Guard, you can change the role of a database using either a switchover or a failover operation.

An Oracle database operates in one of two roles: primary or standby.



A **switchover** is a role reversal between the primary database and one of its standby databases. A switchover ensures no data loss. This is typically done for planned maintenance of the primary system. During a switchover, the primary database transitions to a standby role, and the standby database transitions to the primary role.

A **failover** is when the primary database is unavailable. Failover is performed only in the event of a failure of the primary database, and the failover results in a transition of a standby database to the primary role. The database administrator can configure Oracle Data Guard to ensure no data loss.

The role transitions described in this documentation are invoked manually using SQL statements. You can also use the Oracle Data Guard broker to simplify role transitions and automate failovers using Oracle Enterprise Manager Cloud Control or the DGMGRL command-line interface, as described in [Oracle Data Guard Broker](#).

## 1.3 Oracle Data Guard Broker

The Oracle Data Guard broker is a distributed management framework that automates the creation, maintenance, and monitoring of Oracle Data Guard configurations.

You can use either the Oracle Enterprise Manager Cloud Control graphical user interface (GUI) or the Oracle Data Guard command-line interface (DGMGRL) to:

- Create and enable Oracle Data Guard configurations, including setting up redo transport services and apply services
- Manage an entire Oracle Data Guard configuration from any system in the configuration
- Manage and monitor Oracle Data Guard configurations that contain Oracle RAC primary or standby databases
- Simplify switchovers and failovers by allowing you to invoke them using either a single key click in Oracle Enterprise Manager Cloud Control or a single command in the DGMGRL command-line interface.
- Enable Oracle Data Guard fast-start failover to fail over *automatically* when the primary database becomes unavailable. When fast-start failover is enabled, the Oracle Data Guard broker determines if a failover is necessary and initiates the failover to the specified target standby database automatically, with no need for DBA intervention.

In addition, Oracle Enterprise Manager Cloud Control automates and simplifies:

- Creating a physical or logical standby database from a backup copy of the primary database
- Adding new or existing standby databases to an existing Oracle Data Guard configuration
- Monitoring log apply rates, capturing diagnostic information, and detecting problems quickly with centralized monitoring, testing, and performance tools

### See Also:

*Oracle Data Guard Broker* for more information

## 1.3.1 Using Oracle Enterprise Manager Cloud Control

Oracle Enterprise Manager Cloud Control provides a web-based interface for viewing, monitoring, and administering primary and standby databases in an Oracle Data Guard configuration.

Oracle Enterprise Manager Cloud Control is sometimes referred to simply as Cloud Control.

Enterprise Manager's easy-to-use interfaces, combined with the broker's centralized management and monitoring of the Oracle Data Guard configuration, enhance the Oracle Data Guard solution for high availability, site protection, and data protection of an enterprise.

Using Enterprise Manager, you can perform all management operations either locally or remotely. You can view home pages for Oracle databases, including primary and standby databases and instances, create or add existing standby databases, start and stop instances, monitor instance performance, view events, schedule jobs, and perform backup and recovery operations.

## 1.3.2 Using the Oracle Data Guard Command-Line Interface

The Oracle Data Guard command-line interface (DGMGRL) enables you to control and monitor an Oracle Data Guard configuration from the DGMGRL prompt or within scripts.

You can perform most of the activities required to manage and monitor the databases in the configuration using DGMGRL. See *Oracle Data Guard Broker* for complete DGMGRL reference information and examples.

## 1.4 Oracle Data Guard Protection Modes

Oracle Data Guard provides three distinct modes of data protection.

In some situations, a business cannot afford to lose data regardless of the circumstances. In other situations, the availability of the database may be more important than any potential data loss in the unlikely event of a multiple failure. Finally, some applications require maximum database performance at all times, and can therefore tolerate a small amount of data loss if any component fails. The following are brief descriptions of the protection modes available for each of these situations:

### Maximum Availability

This protection mode provides the highest level of data protection that is possible without compromising the availability of a primary database. With Oracle Data Guard, transactions do not commit until all redo data needed to recover those transactions has either been received in memory or written to the standby redo log (depending upon configuration) on at least one synchronized standby database. If the primary database cannot write its redo stream to at least one synchronized standby database, it operates as if it were in maximum performance mode to preserve primary database availability until it is again able to write its redo stream to a synchronized standby database.

This protection mode ensures zero data loss except in the case of certain double faults, such as failure of a primary database after failure of the standby database.

### Maximum Performance

This is the default protection mode. It provides the highest level of data protection that is possible without affecting the performance of a primary database. This is accomplished by allowing transactions to commit as soon as all redo data generated by those transactions has been written to the online log. Redo data is also written to one or more standby databases, but this is done asynchronously with respect to transaction commitment, so primary database performance is unaffected by delays in writing redo data to the standby database(s).

This protection mode offers slightly less data protection than maximum availability mode and has minimal impact on primary database performance.

### Maximum Protection

This protection mode ensures that no data loss occurs if the primary database fails. To provide this level of protection, the redo data needed to recover a transaction must be written to both the online redo log and to the standby redo log on at least one synchronized standby database before the transaction commits. To ensure that data loss cannot occur, the primary database shuts down, rather than continue processing transactions, if it cannot write its redo stream to at least one synchronized standby database.

All three protection modes require that specific redo transport options be used to send redo data to at least one standby database.

#### See Also:

- [Oracle Data Guard Protection Modes](#) for more detailed descriptions of these modes and for information about setting the protection mode of a primary database

## 1.5 Client Failover

A high availability architecture requires a fast failover capability for databases and database clients. Client failover encompasses failure notification, stale connection cleanup, and transparent reconnection to the new primary database.

Oracle Database provides the capability to integrate database failover with failover procedures that automatically redirect clients to a new primary database within seconds of a database failover.

 **See Also:**

- *Oracle Data Guard Broker* for information about configuration requirements specific to Oracle Data Guard for Fast Application Notification (FAN), Fast Connection Failover (FCF), and role-specific database services
- The Maximum Availability Architecture client failover best practices technical brief at <http://www.oracle.com/goto/maa>

## 1.5.1 Application Continuity

Application Continuity is an Oracle Database feature that enables rapid and nondisruptive replays of requests against the database after a recoverable error that made the database session unavailable.

Application Continuity is supported for Oracle Data Guard switchovers to physical standby databases. It is also supported for fast-start failover to physical standbys in maximum availability data protection mode. To use Application Continuity, the primary and standby databases must be licensed for Oracle Real Application Clusters (Oracle RAC) or Oracle Active Data Guard.

 **See Also:**

- *Oracle Real Application Clusters Administration and Deployment Guide* for information about Application Continuity

## 1.6 Oracle Data Guard and Complementary Technologies

Oracle Database provides several unique technologies that complement Oracle Data Guard to help keep business critical systems running with greater levels of availability and data protection than when using any one solution by itself.

The following list summarizes some Oracle high-availability technologies:

- Oracle Real Application Clusters (Oracle RAC)  
Oracle RAC enables multiple independent servers that are linked by an interconnect to share access to an Oracle database, providing high availability, scalability, and redundancy during failures. Oracle RAC and Oracle Data Guard together provide the benefits of both system-level, site-level, and data-level protection, resulting in high levels of availability and disaster recovery without loss of data:
  - Oracle RAC addresses system failures by providing rapid and automatic recovery from failures, such as node failures and instance crashes. It also provides increased scalability for applications.

- Oracle Data Guard addresses site failures and data protection through transactionally consistent primary and standby databases that do not share disks, enabling recovery from site disasters and data corruption.

Many different architectures using Oracle RAC and Oracle Data Guard are possible depending on the use of local and remote sites and the use of nodes and a combination of logical and physical standby databases. See [Oracle Data Guard and Oracle Real Application Clusters](#) for Oracle RAC and Oracle Data Guard integration.

- Oracle Real Application Clusters One Node (Oracle RAC One Node)

Oracle RAC One Node provides enhanced high availability for noncluster databases, protecting them from both planned and unplanned downtime. Oracle RAC One Node provides the following:

- Always-on noncluster database services
- Better consolidation for database servers
- Enhanced server virtualization
- Lower cost development and test platform for full Oracle RAC

In addition, Oracle RAC One Node facilitates the consolidation of database storage, standardizes your database environment, and, when necessary, enables you to upgrade to a full, multinode Oracle RAC database without downtime or disruption.

As of Oracle Database 11g Release 2 (11.2.0.2), Oracle Data Guard and Oracle Data Guard broker are fully integrated with Oracle Real Application Clusters One Node (Oracle RAC One Node).

- Flashback Database

The Flashback Database feature provides fast recovery from logical data corruption and user errors. By allowing you to flash back in time, previous versions of business information that might have been erroneously changed or deleted can be accessed once again. This feature:

- Eliminates the need to restore a backup and roll forward changes up to the time of the error or corruption. Instead, Flashback Database can *roll back* an Oracle database to a previous point-in-time, without restoring data files.
- Provides an alternative to delaying the application of redo to protect against user errors or logical corruptions. Therefore, standby databases can be more closely synchronized with the primary database, thus reducing failover and switchover times.
- Avoids the need to completely re-create the original primary database after a failover. The failed primary database can be flashed back to a point in time before the failover and converted to be a standby database for the new primary database.

See *Oracle Database Backup and Recovery User's Guide* for information about Flashback Database, and [Specifying a Time Delay for the Application of Archived Redo Log Files](#) for information describing the application of redo data.

- Recovery Manager (RMAN)

RMAN is an Oracle utility that simplifies backing up, restoring, and recovering database files. Like Oracle Data Guard, RMAN is a feature of the Oracle database and does not require separate installation. Oracle Data Guard is well integrated with RMAN, allowing you to:

- Use the Recovery Manager `DUPLICATE` command to create a standby database from backups of your primary database.
- Take backups on a physical standby database instead of the production database, relieving the load on the production database and enabling efficient use of system resources on the standby site. Moreover, backups can be taken while the physical standby database is applying redo.
- Help manage archived redo log files by automatically deleting the archived redo log files used for input after performing a backup.

See [Creating a Standby Database with Recovery Manager](#).

- Oracle Global Data Services (GDS)

Oracle Global Data Services (GDS) applies the Oracle RAC service model to pools of globally distributed databases, providing dynamic load balancing, failover, and centralized service management for a set of replicated databases that offer common services. The set of databases can include Oracle RAC and single-instance Oracle databases interconnected through Oracle Data Guard, Oracle GoldenGate, or any other replication technology.

GDS is integrated with Oracle Data Guard broker. This allows role-specific global services to be automatically started and stopped as appropriate when role transitions occur within an Oracle Data Guard broker configuration.

GDS allows the specification of a replication lag limit for a global service. If the lag limit is exceeded at a given replica, the global service is temporarily stopped at that replica and new client requests are routed to a replica that satisfies the lag limit. The global service is automatically restarted at the original replica when the replication lag becomes less than the lag limit.

## 1.7 Oracle Active Data Guard Supports Oracle Sharding

Oracle Sharding allows you to horizontally partition data across multiple independent Oracle databases and route database connection requests to databases that contain appropriate data. Oracle Data Guard and Oracle Sharding are integrated technologies.

Sharding splits data into multiple independent databases (shards) that do not share any physical resources. Sharding is usually combined with data replication, such as that provided by Oracle Data Guard. Oracle Data Guard provides fast single-master replication of an entire Oracle Database. In an Oracle Data Guard configuration there is an updateable primary database and one or more standby databases which can be open for read-only access. Replication can improve performance and scalability of a sharded database and provide high-availability and disaster recovery. Replication topology in a sharded database is specified using the `-repl` option on the `GDSCTL create shardcatalog` command. The default replication topology is Oracle Data Guard.

Oracle Sharding supports two methods of sharding: system-managed and composite. The sharding method is specified with the `GDSCTL` command `CREATE SHARDCATALOG`.

Shards that belong to a shardgroup are usually located in the same data center. An entire shardgroup can be fully replicated to one or more shardgroups in the same or different data centers.

### System-Managed Sharding With Oracle Data Guard Replication

In system-managed sharding, the logical unit of replication is a group of shards called shardgroup. In system-managed sharding, a shardgroup contains all data stored in the sharded database. The data is automatically distributed across shards using partitioning by consistent hash (consistent hash is a partitioning strategy commonly used in scalable distributed systems). The partitioning algorithm evenly and randomly distributes data across shards. The following figure illustrates how Oracle Data Guard replication is used with system-managed sharding. There is a primary shardgroup – Shardgroup 1 and two standby shardgroups - Shardgroup 2 and Shardgroup 3.

**Figure 1-4 System-Managed Sharding With Oracle Data Guard Replication**

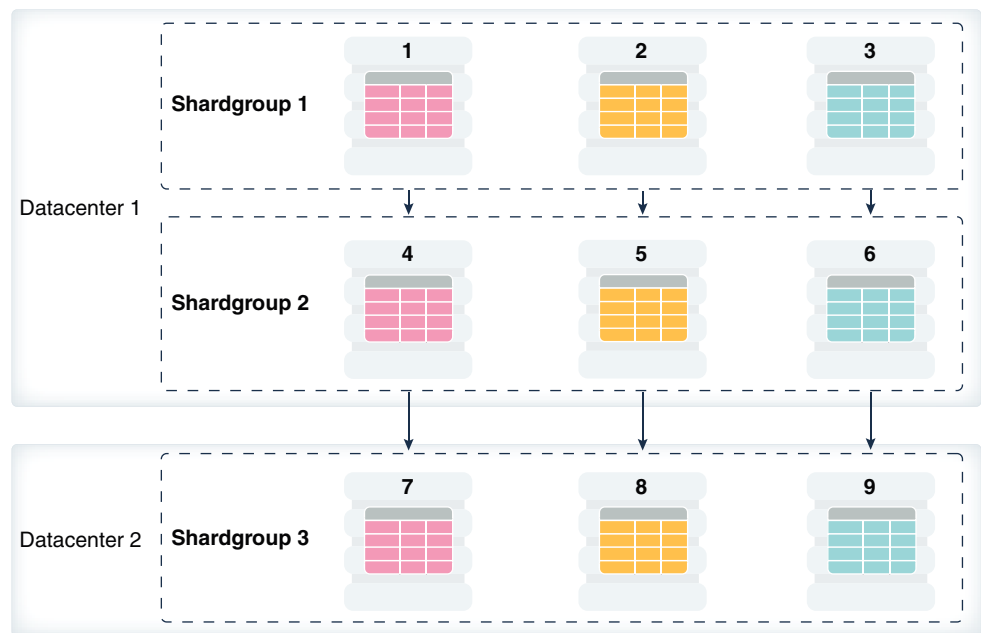

Shardgroup 1 consists of Oracle Data Guard primary databases (shards 1, 2, 3). Shardgroup 2 consists of local standby databases (shards 4, 5, 6) which are located in the same datacenter and configured for synchronous replication. And Shardgroup 3 consists of remote standbys (shards 7, 8, 9) located in a different datacenter and configured for asynchronous replication. The default replication topology is Oracle Data Guard. To open each standby in the configuration in read-only mode, you must enable Oracle Active Data Guard. This is done using the `-deploy_as ACTIVE_STANDBY` option on the `GDSCTL add shardgroup` command.

The sharded database shown in the previous figure consists of three sets of replicated shards: {1, 4, 7}, {2, 5, 8} and {3, 6, 9}. Each set of replicated shards is managed as an Oracle Data Guard broker configuration with fast-start failover enabled.

To deploy replication, you only need to specify the properties of shardgroups (region, role, etc) and add shards to them. Oracle Sharding automatically configures Oracle Data Guard and starts a fast-start failover observer for each set of replicated shards. It also provides load balancing of read-only workloads, role-based global services, and replication lag and locality-based routing.

To deploy the configuration shown in the previous figure, execute the following GDSCTL commands:

```
CREATE SHARDCATALOG -database host00:1521:shardcat -region dc1, dc2

ADD GSM -gsm gsm1 -listener 1571 -catalog host00:1521:shardcat -region
dc1
ADD GSM -gsm gsm2 -listener 1571 -catalog host00:1521:shardcat -region
dc2

ADD SHARDGROUP -shardgroup shardgroup1 -region dc1 -deploy_as primary
ADD SHARDGROUP -shardgroup shardgroup2 -region dc1 -deploy_as standby
ADD SHARDGROUP -shardgroup shardgroup3 -region dc2 -deploy_as standby

CREATE SHARD -shardgroup shardgroup1 -destination host01 -credential
oracle_cred -netparamfile /home/oracle/netca_dbhome.rsp
CREATE SHARD -shardgroup shardgroup1 -destination host02 -credential
oracle_cred -netparamfile /home/oracle/netca_dbhome.rsp
CREATE SHARD -shardgroup shardgroup1 -destination host03 -credential
oracle_cred -netparamfile /home/oracle/netca_dbhome.rsp
.....
CREATE SHARD -shardgroup shardgroup3 -destination host09 -credential
oracle_cred -netparamfile /home/oracle/netca_dbhome.rsp

DEPLOY
```

### Composite Sharding With Oracle Data Guard Replication

Composite sharding combines features of system-managed sharding and user-managed sharding. In composite sharding the logical unit of replication is a group of shards called a shardgroup (as in system-managed sharding). Also in composite sharding, a sharded database consists of multiple shardspaces (as in user-managed sharding), however, each shardspace, instead of replicated shards, contains replicated shardgroups as shown in the following figure.



**Figure 1-5 Composite Sharding With Oracle Data Guard Replication**

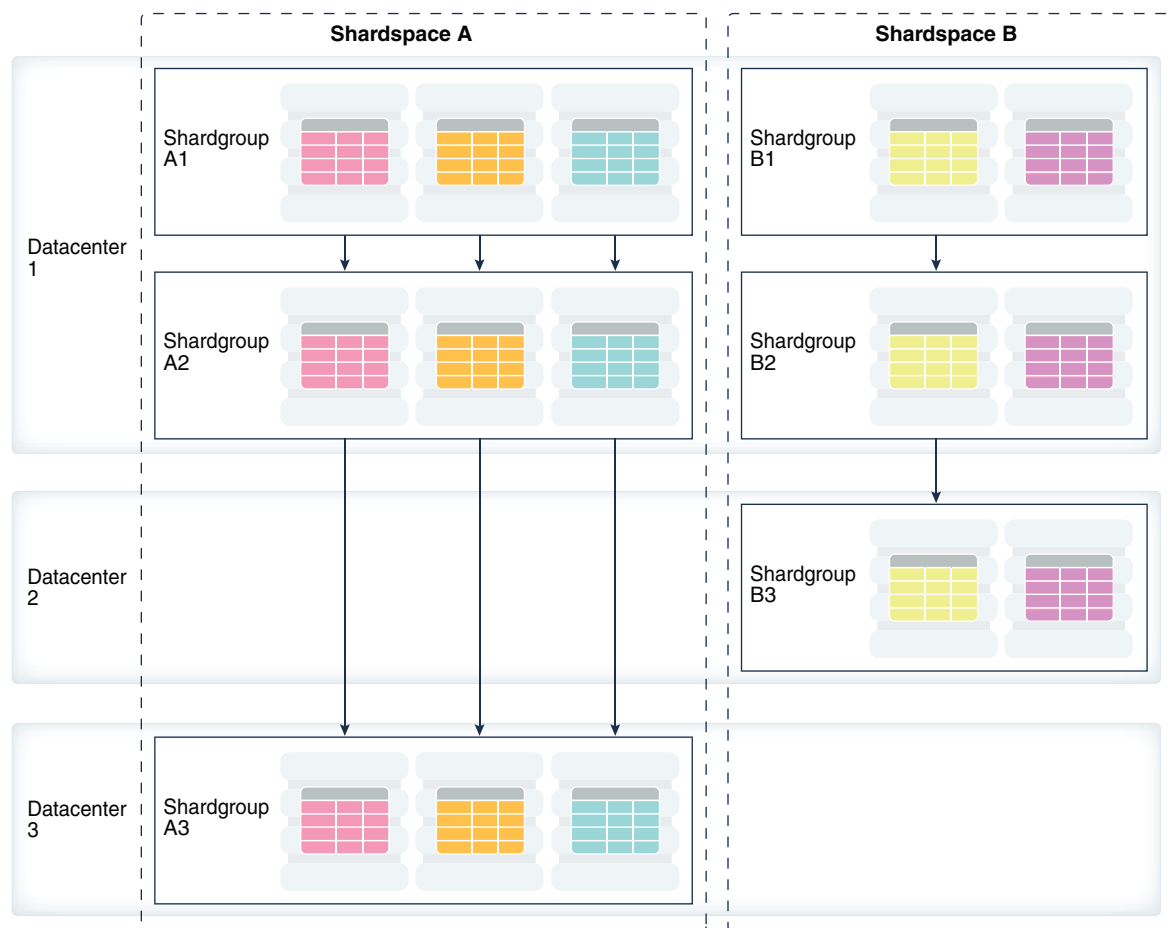

To deploy the configuration shown in the previous figure, execute the following GDSCTL commands:

```
CREATE SHARDCATALOG -sharding composite -database host00:1521:cat -
region dc1, dc2, dc3

ADD GSM -gsm gsm1 -listener 1571 -catalog host00:1521:cat -region dc1
ADD GSM -gsm gsm2 -listener 1571 -catalog host00:1521:cat -region dc2
ADD GSM -gsm gsm3 -listener 1571 -catalog host00:1521:cat -region dc3

ADD SHARDSPACE -shardspace shardspace_a
ADD SHARDSPACE -shardspace shardspace_b

ADD SHARDGROUP -shardgroup shardgroup_a1 -shardspace shardspace_a -
region dc1
-deploy_as primary
ADD SHARDGROUP -shardgroup shardgroup_a2 -shardspace shardspace_a -
region dc1 -deploy_as standby
ADD SHARDGROUP -shardgroup shardgroup_a3 -shardspace shardspace_a -
region dc3 -deploy_as standby
ADD SHARDGROUP -shardgroup shardgroup_b1 -shardspace shardspace_a -
```

```
region dc1
-deploy_as primary
ADD SHARDGROUP -shardgroup shardgroup_b2 -shardspace shardspace_a -
region dc1 -deploy_as standby
ADD SHARDGROUP -shardgroup shardgroup_b3 -shardspace shardspace_a -
region dc2 -deploy_as standby

CREATE SHARD -shardgroup shardgroup_a1 -destination host01 -credential
orcl_cred -netparamfile /home/oracle/netca_dbhome.rsp
.....
CREATE SHARD -shardgroup shardgroup_b3 -destination host09 -credential
orcl_cred -netparamfile /home/oracle/netca_dbhome.rsp

DEPLOY
```

### Related Topics

- *Oracle Database Administrator's Guide*
- *Oracle Database Global Data Services Concepts and Administration Guide*

## 1.8 Summary of Oracle Data Guard Benefits

Oracle Data Guard provides an efficient and comprehensive disaster recovery and high availability solution.

Oracle Data Guard offers these benefits:

- High availability  
Oracle Data Guard's easy-to-manage switchover and failover capabilities allow role reversals between primary and standby databases, minimizing the downtime of the primary database for planned and unplanned outages.
- Complete data protection  
Oracle Data Guard can ensure zero data loss, even in the face of unforeseen disasters. A standby database provides a safeguard against unplanned outages of all types, including data corruption and administrative error. Because the redo data received from a primary database is validated at a standby database, physical corruptions that can occur at a primary database are not propagated to the standby database. Additional validation performed at a standby database also prevents logical intra-block corruptions and lost-write corruptions from propagating to the standby. Similarly, administrative errors such as accidental file deletions by a storage administrator are not propagated to a standby database. A physical standby database can also be used to protect against user errors either by delaying the redo apply or by using Flashback Database to rewind the standby and extract a good copy of the data.
- Efficient use of system resources  
The standby database tables that are updated with redo data received from the primary database can be used for other tasks such as backups, reporting, summations, and queries, thereby reducing the primary database workload necessary to perform these tasks, saving valuable CPU and I/O cycles.
- Flexibility in data protection to balance availability against performance requirements

Oracle Data Guard offers maximum protection, maximum availability, and maximum performance modes to help enterprises balance data availability against system performance requirements.

- Automatic gap detection and resolution

If connectivity is lost between the primary and one or more standby databases (for example, due to network problems), then redo data being generated on the primary database cannot be sent to those standby databases. After a connection is reestablished, the missing archived redo log files (referred to as a gap) are automatically detected by Oracle Data Guard, which then automatically transmits the missing archived redo log files to the standby databases. The standby databases are synchronized with the primary database, without manual intervention by the DBA.

- Centralized and simple management

The Oracle Data Guard broker provides a graphical user interface and a command-line interface to automate management and operational tasks across multiple databases in an Oracle Data Guard configuration. The broker also monitors all of the systems within a single Oracle Data Guard configuration.

- Integration with Oracle Database

Oracle Data Guard is a feature of Oracle Database Enterprise Edition and does not require separate installation.

- Automatic role transitions

When fast-start failover is enabled, the Oracle Data Guard broker automatically fails over to a synchronized standby site in the event of a disaster at the primary site, requiring no intervention by the DBA. In addition, applications are automatically notified of the role transition.

# 2

## Getting Started with Oracle Data Guard

The information in this section describes how to get started using Oracle Data Guard.

See the following topics:

- [Standby Database Types](#)
- [User Interfaces for Administering Oracle Data Guard Configurations](#)
- [Oracle Data Guard Operational Prerequisites](#)
- [Standby Database Directory Structure Considerations](#)
- [Moving the Location of Online Data Files](#)

### 2.1 Standby Database Types

A **standby database** is a transactionally consistent copy of an Oracle production database that is initially created from a backup copy of the primary database.

Once the standby database is created and configured, Oracle Data Guard automatically maintains the standby database by transmitting primary database redo data to the standby system, where the redo data is applied to the standby database.

A standby database can be one of these types: a physical standby database, a logical standby database, or a snapshot standby database. If needed, either a physical or a logical standby database can assume the role of the primary database and take over production processing. An Oracle Data Guard configuration can include any combination of these types of standby databases.

#### 2.1.1 Physical Standby Databases

A physical standby database is an exact, block-for-block copy of a primary database.

A physical standby is maintained as an exact copy through a process called Redo Apply, in which redo data received from a primary database is continuously applied to a physical standby database using the database recovery mechanisms.

A physical standby database can be opened for read-only access and used to offload queries from a primary database. If a license for the Oracle Active Data Guard option has been purchased, Redo Apply can be active while the physical standby database is open, thus allowing queries to return results that are identical to what would be returned from the primary database. This capability is known as the real-time query feature.

 **See Also:**

- ["Opening a Physical Standby Database "](#)
- *Oracle Database Licensing Information* for more information about Oracle Active Data Guard

### Benefits of a Physical Standby Database

A physical standby database provides the following benefits:

- **Disaster recovery and high availability**

A physical standby database is a robust and efficient disaster recovery and high availability solution. Easy-to-manage switchover and failover capabilities allow easy role reversals between primary and physical standby databases, minimizing the downtime of the primary database for planned and unplanned outages.
- **Data protection**

A physical standby database can prevent data loss, even in the face of unforeseen disasters. A physical standby database supports all datatypes, and all DDL and DML operations that the primary database can support. It also provides a safeguard against data corruptions and user errors. Storage level physical corruptions on the primary database are not propagated to a standby database. Similarly, logical corruptions or user errors that would otherwise cause data loss can be easily resolved.
- **Reduction in primary database workload**

Oracle Recovery Manager (RMAN) can use a physical standby database to off-load backups from a primary database, saving valuable CPU and I/O cycles.

A physical standby database can also be queried while Redo Apply is active, which allows queries to be offloaded from the primary to a physical standby, further reducing the primary workload.
- **Performance**

The Redo Apply technology used by a physical standby database is the most efficient mechanism for keeping a standby database updated with changes being made at a primary database because it applies changes using low-level recovery mechanisms which bypass all SQL level code layers.

## 2.1.2 Logical Standby Databases

A logical standby database is initially created as an identical copy of the primary database, but it later can be altered to have a different structure.

The logical standby database is updated by executing SQL statements. The flexibility of a logical standby database lets you upgrade Oracle Database software (patch sets and new Oracle Database releases) and perform other database maintenance in rolling fashion with almost no downtime. From Oracle Database 11g onward, the transient logical database rolling upgrade process can also be used with existing physical standby databases.

Oracle Data Guard automatically applies information from the archived redo log file or standby redo log file to the logical standby database by transforming the data in the log files into SQL statements and then executing the SQL statements on the logical standby database. Because the logical standby database is updated using SQL statements, it must remain open. Although the logical standby database is opened in read/write mode, its target tables for the regenerated SQL are available only for read-only operations. While those tables are being updated, they can be used simultaneously for other tasks such as reporting, summations, and queries.

A logical standby database has some restrictions on data types, types of tables, and types of DDL and DML operations. See [Data Type and DDL Support on a Logical Standby Database](#) for information on data type and DDL support on logical standby databases.

### Benefits of a Logical Standby Database

A logical standby database is ideal for high availability (HA) while still offering data recovery (DR) benefits. Compared to a physical standby database, a logical standby database provides significant additional HA benefits:

- Minimizing downtime on software upgrades

A logical standby database is ideal for upgrading an Oracle Data Guard configuration in a rolling fashion. Logical standby can be used to greatly reduce downtime associated with applying patchsets and new software releases. A logical standby can be upgraded to the new release and then switched over to become the active primary. This allows full availability while the old primary is converted to a logical standby and the patchset is applied. Logical standbys provide the underlying platform for the `DBMS_ROLLING` PL/SQL package, which provides functionality that allows you to make your Oracle Data Guard configuration highly available in the context of rolling upgrades and other storage reorganization.

- Support for reporting and decision support requirements

A key benefit of logical standby is that significant auxiliary structures can be created to optimize the reporting workload; structures that could have a prohibitive impact on the primary's transactional response time. A logical standby can have its data physically reorganized into a different storage type with different partitioning, have many different indexes, have on-demand refresh materialized views created and maintained, and can be used to drive the creation of data cubes and other OLAP data views. However, a logical standby database does not allow for any transformation of your data (such as replicating only a subset of columns or allowing additional columns on user tables). For those types of reporting activities, Oracle GoldenGate is Oracle's preferred solution.

## 2.1.3 Snapshot Standby Databases

A snapshot standby database is a type of updatable standby database that provides full data protection for a primary database.

A snapshot standby database receives and archives, but does not apply, redo data from its primary database. Redo data received from the primary database is applied when a snapshot standby database is converted back into a physical standby database, after discarding all local updates to the snapshot standby database.

A snapshot standby database diverges from its primary database over time because redo data from the primary database is not applied as it is received. Local updates to the snapshot standby database cause additional divergence. The data in the primary

database is fully protected however, because a snapshot standby can be converted back into a physical standby database at any time, and the redo data received from the primary is then applied.

### Benefits of a Snapshot Standby Database

A snapshot standby database is a fully updatable standby database that provides disaster recovery and data protection benefits that are similar to those of a physical standby database. Snapshot standby databases are best used in scenarios where the benefit of having a temporary, updatable snapshot of the primary database justifies the increased time to recover from primary database failures.

The benefits of using a snapshot standby database include the following:

- It provides an exact replica of a production database for development and testing purposes, while maintaining data protection at all times. You can use the Oracle Real Application Testing option to capture primary database workload and then replay it for test purposes on the snapshot standby.
- It can be easily refreshed to contain current production data by converting to a physical standby and resynchronizing.

The ability to create a snapshot standby, test, resynchronize with production, and then again create a snapshot standby and test, is a cycle that can be repeated as often as desired. The same process can be used to easily create and regularly update a snapshot standby for reporting purposes where read/write access to data is required.



#### See Also:

- *Oracle Database Testing Guide* for more information about Oracle Real Application Testing and the license required to use it

## 2.2 User Interfaces for Administering Oracle Data Guard Configurations

Oracle Data Guard provides several interfaces that you can use to configure, implement, and manage an Oracle Data Guard configuration.

- Oracle Enterprise Manager Cloud Control  
Oracle Enterprise Manager Cloud Control provides a GUI interface for the Oracle Data Guard broker that automates many of the tasks involved in creating, configuring, and monitoring an Oracle Data Guard environment. See the Oracle Enterprise Manager Cloud Control online Help for information about the GUI and its wizards.
- SQL\*Plus Command-line interface  
Several SQL\*Plus statements use the `STANDBY` keyword to specify operations on a standby database. Other SQL statements do not include standby-specific syntax, but they are useful for performing operations on a standby database. See [SQL Statements Relevant to Oracle Data Guard](#) for a list of the relevant statements.
- Initialization parameters

Several initialization parameters are used to define the Oracle Data Guard environment. See [Initialization Parameters](#) for a list of the relevant initialization parameters.

- Oracle Data Guard broker command-line interface (DGMGRL)  
The DGMGRL command-line interface is an alternative to using Oracle Enterprise Manager Cloud Control. The DGMGRL command-line interface is useful if you want to use the broker to manage an Oracle Data Guard configuration from batch programs or scripts. See *Oracle Data Guard Broker* for complete information.

## 2.3 Oracle Data Guard Operational Prerequisites

The use of Oracle Data Guard requires certain hardware and software prerequisites.

- [Hardware and Operating System Requirements](#)
- [Oracle Software Requirements](#)

### 2.3.1 Hardware and Operating System Requirements

The same release of Oracle Database Enterprise Edition must be installed on the primary database and all standby databases, except during rolling database upgrades using logical or transient logical standby databases.

As of Oracle Database 11g, Oracle Data Guard provides increased flexibility for Oracle Data Guard configurations in which the primary and standby systems may have different CPU architectures, operating systems (for example, Windows and Linux), operating system binaries (32-bit/64-bit), or Oracle database binaries (32-bit/64-bit).

This increased mixed-platform flexibility is subject to the current restrictions documented in the My Oracle Support notes 413484.1 and 1085687.1 at <http://support.oracle.com>.

Note 413484.1 discusses mixed-platform support and restrictions for physical standbys.

Note 1085687.1 discusses mixed-platform support and restrictions for logical standbys.

#### See Also:

- [Using SQL Apply to Upgrade the Oracle Database](#) for information about rolling database upgrades

### 2.3.2 Oracle Software Requirements

To use Oracle Data Guard, you must meet certain Oracle software requirements.

- Oracle Data Guard is available only as a feature of Oracle Database Enterprise Edition. It is not available with Oracle Database Standard Edition.



 **Note:**

It is possible to simulate a standby database environment with databases running Oracle Database Standard Edition. You can do this by manually transferring archived redo log files using an operating system copy utility or using custom scripts that periodically send archived redo log files from one database to the other, registering them, and using media recovery to roll forward the copy of the database at the disaster recovery site. Such a configuration does not provide the ease-of-use, manageability, performance, and disaster-recovery capabilities available with Oracle Data Guard.

- In general, a physical standby database must have the same Database Home version as the primary database including Patch Set Exceptions (PSEs), Critical Patch Updates (CPUs), and Patch Set Updates (PSUs), unless an Oracle Data Guard Standby-First Patch Apply process is in progress (as described in My Oracle Support note 1265700.1 at <http://support.oracle.com>).

Additionally, as of Oracle Database 11g Release 2 (11.2.0.1), a physical standby database can be used to install eligible one-off patches, patch set updates (PSUs), and critical patch updates (CPUs), in rolling fashion. For more information about this functionality, see the My Oracle Support note 1265700.1 at <http://support.oracle.com>.

- Using Oracle Data Guard SQL Apply, you can perform a rolling upgrade of the Oracle database software from patch set release  $n$  (minimally, this must be release 10.1.0.3) to any higher versioned patch set or major version release. During a rolling upgrade, you can run different releases of the Oracle database on the primary and logical standby databases while you upgrade them, one at a time. For complete information, see [Using SQL Apply to Upgrade the Oracle Database](#) and the ReadMe file for the applicable Oracle Database 10g patch set release.
- The `COMPATIBLE` database initialization parameter must be set to the same value on all databases in an Oracle Data Guard configuration, except when using a logical standby database, which can have a higher `COMPATIBLE` setting than the primary database.
- The primary database must run in `ARCHIVELOG` mode. See *Oracle Database Administrator's Guide* for more information.
- The primary database can be a single instance database or an Oracle Real Application Clusters (Oracle RAC) database. The standby databases can be single instance databases or Oracle RAC databases, and these standby databases can be a mix of physical, logical, and snapshot types.
- Each primary database and standby database must have its own control file.
- If a standby database is located on the same system as the primary database, the archival directories for the standby database *must* use a different directory structure than the primary database. Otherwise, the standby database may overwrite the primary database files.
- To protect against unlogged direct writes in the primary database that cannot be propagated to the standby database, turn on `FORCE LOGGING` at the primary database before performing data file backups for standby creation. Keep the database in `FORCE LOGGING` mode as long as the standby database is required.

- The user accounts you use to manage the primary and standby database instances must have either the `SYSDG` or `SYSDBA` administrative privilege.
- For operational simplicity, Oracle recommends that when you set up Oracle Automatic Storage Management (Oracle ASM) and Oracle Managed Files (OMF) in an Oracle Data Guard configuration that you set it up symmetrically on the primary and standby database(s). If any database in the Oracle Data Guard configuration uses Oracle ASM, OMF, or both, then every database in the configuration should use Oracle ASM, OMF, or both, respectively, unless you are purposely implementing a mixed configuration for migration or maintenance purposes. See the scenario in [Creating a Standby Database That Uses OMF or Oracle ASM](#) for more information.

 **Note:**

Because some applications that perform updates involving time-based data cannot handle data entered from multiple time zones, consider setting the time zone for the primary and remote standby systems to be the same to ensure the chronological ordering of records is maintained after a role transition.

## 2.4 Standby Database Directory Structure Considerations

The directory structure of the various standby databases is important because it determines the path names for the standby data files, archived redo log files, and standby redo log files.

If possible, the data files, log files, and control files on the primary and standby systems should have the same names and path names and use Optimal Flexible Architecture (OFA) naming conventions. The archival directories on the standby database should also be identical between sites, including size and structure. This strategy allows other operations such as backups, switchovers, and failovers to execute the same set of steps, reducing the maintenance complexity.

 **See Also:**

Your operating system-specific Oracle documentation for more information about Optimal Flexible Architecture (OFA)

Otherwise, you must set the filename conversion parameters (as shown in [Table 2-1](#)) or rename the data file. Nevertheless, if you need to use a system with a different directory structure or place the standby and primary databases on the same system, you can do so with a minimum of extra administration.

The three basic configuration options are illustrated in [Figure 2-1](#). These include:

- A standby database on the same system as the primary database that uses a different directory structure than the primary system. This is illustrated in [Figure 2-1](#) as `Standby1`.

If you have a standby database on the same system as the primary database, you *must* use a different directory structure. Otherwise, the standby database attempts to overwrite the primary database files.

- A standby database on a separate system that uses the same directory structure as the primary system. This is illustrated in [Figure 2-1](#) as Standby2. This is the recommended method.
- A standby database on a separate system that uses a different directory structure than the primary system. This is illustrated in [Figure 2-1](#) as Standby3.

 **Note:**

For operational simplicity, Oracle recommends that when you set up Oracle Automatic Storage Management (Oracle ASM) and Oracle Managed Files (OMF) in an Oracle Data Guard configuration that you set it up symmetrically on the primary and standby database(s). If any database in the Oracle Data Guard configuration uses Oracle ASM, OMF, or both, then every database in the configuration should use Oracle ASM, OMF, or both, respectively, unless you are purposely implementing a mixed configuration for migration or maintenance purposes. See the scenario in [Creating a Standby Database That Uses OMF or Oracle ASM](#) for more information.

Figure 2-1 Possible Standby Configurations

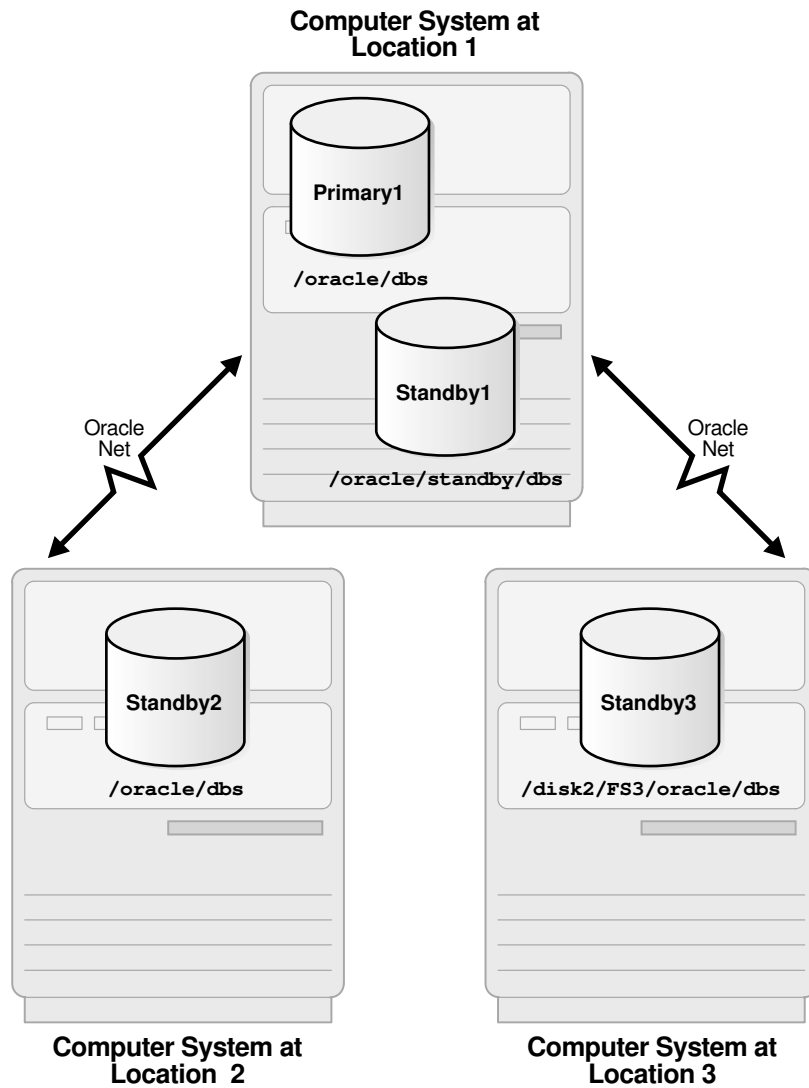

Table 2-1 describes possible configurations of primary and standby databases and the consequences of each.

**Table 2-1 Standby Database Location and Directory Options**

Standby System	Directory Structure	Consequences
Same as primary system	Different than primary system (required)	<ul style="list-style-type: none"> <li>You can either manually rename files or set up the <code>DB_FILE_NAME_CONVERT</code> and <code>LOG_FILE_NAME_CONVERT</code> initialization parameters on the standby database to automatically update the path names for primary database data files and archived redo log files and standby redo log files in the standby database control file. (See <a href="#">Set Primary Database Initialization Parameters</a>.)</li> <li>The standby database does not protect against disasters that destroy the system on which the primary and standby databases reside, but it does provide switchover capabilities for planned maintenance.</li> </ul>
Separate system	Same as primary system	<ul style="list-style-type: none"> <li>You do not need to rename primary database files, archived redo log files, and standby redo log files in the standby database control file, although you can still do so if you want a new naming scheme (for example, to spread the files among different disks).</li> <li>By locating the standby database on separate physical media, you safeguard the data on the primary database against disasters that destroy the primary system.</li> </ul>
Separate system	Different than primary system	<ul style="list-style-type: none"> <li>You can either manually rename files or set up the <code>DB_FILE_NAME_CONVERT</code> and <code>LOG_FILE_NAME_CONVERT</code> initialization parameters on the standby database to automatically rename the data files (see <a href="#">Set Primary Database Initialization Parameters</a>).</li> <li>By locating the standby database on separate physical media, you safeguard the data on the primary database against disasters that destroy the primary system.</li> </ul>

## 2.5 Moving the Location of Online Data Files

You can move the location of an online data file from one physical file to another physical file while the database is actively accessing the file.

To move the location of the file, you use the SQL statement `ALTER DATABASE MOVE DATAFILE`.

An operation performed with the `ALTER DATABASE MOVE DATAFILE` statement increases the availability of the database because it does not require that the database be shut down to move the location of an online data file.

You can perform an online move data file operation independently on the primary and on the standby (either physical or logical). The standby is not affected when a data file is moved on the primary, and vice versa.

On a physical standby, an online move data file operation can be executed while standby recovery is running if the instance that opens the database is in read-only mode. This functionality requires an Oracle Active Data Guard license.

### 2.5.1 Restrictions When Moving the Location of Online Data Files

There are restrictions when you move the location of online data files.

- You cannot use the SQL `ALTER DATABASE MOVE DATAFILE` command to rename or relocate an online data file on a physical standby that is a fast-start failover target if the standby is mounted, but not open.
- The online move data file operation cannot be executed on physical standby while standby recovery is running in a mounted but not open instance.
- The online move data file operation may get terminated if the standby recovery process takes the data file offline, shrinks the file, or drops the tablespace.
- On a primary database, the online move data file operation cannot be run on a file that belongs to a pluggable database (PDB) that has been closed on all instances of the primary database.

 **See Also:**

- *Oracle Database Administrator's Guide* for more information about renaming and relocating online data files
- *Oracle Database SQL Language Reference* for more information about the `ALTER DATABASE MOVE DATAFILE` statement

# 3

## Creating a Physical Standby Database

You can manually create a physical standby database in maximum performance mode using asynchronous redo transport and real-time apply, the default Oracle Data Guard configuration.

See the following main topics:

- [Preparing the Primary Database for Standby Database Creation](#)
- [Step-by-Step Instructions for Creating a Physical Standby Database](#)
- [Post-Creation Steps](#)
- [Using DBCA to Create a Data Guard Standby](#)
- [Creating a Physical Standby of a CDB](#)
- [Creating a PDB in a Primary Database](#)

### See Also:

- *Oracle Database Administrator's Guide* for information about creating and using server parameter files
- Enterprise Manager online help system for information about using the Oracle Data Guard broker graphical user interface (GUI) to automatically create a physical standby database
- [Creating a Standby Database with Recovery Manager](#) for information about alternative methods of creating a physical standby database that automate much of the process by using Oracle Recovery Manager (RMAN) and either backup based duplication or active duplication over a network
- *Oracle Data Guard Broker* for information about configuring a database so that it can be managed by Oracle Data Guard broker

### Note:

If you are working in a multitenant container database (CDB) environment, then see [Creating a Physical Standby of a CDB](#) for information about behavioral differences from non-CDB environments. For instance, in a CDB environment, many DBA views have analogous CDB views that you should use instead.

## 3.1 Preparing the Primary Database for Standby Database Creation

Before you create a standby database you must first ensure the primary database is properly configured.

Perform the following tasks on the primary database to prepare for physical standby database creation:

- [Enable an Appropriate Logging Mode](#)
- [Configure Redo Transport Authentication](#)
- [Configure the Primary Database to Receive Redo Data](#)
- [Set Primary Database Initialization Parameters](#)
- [Enable Archiving](#)



### Note:

Perform these preparatory tasks only once. After you complete these steps, the database is prepared to serve as the primary database for one or more standby databases.

### 3.1.1 Enable an Appropriate Logging Mode

As part of preparing the primary database for standby database creation, you must enable a logging mode appropriate to the way you plan to use the Data Guard configuration.

The default logging mode of a database that is not part of a Data Guard configuration allows certain data loading operations to be performed in a nonlogged manner. This default mode is not appropriate to a database with a standby because it leads to the loaded data being missing from the standby, which requires manual intervention to fix. In addition to the default logging mode, there are three other modes that are appropriate for a primary database:

- `FORCE LOGGING` mode prevents any load operation from being performed in a nonlogged manner. This can slow down the load process because the loaded data must be copied into the redo logs. `FORCE LOGGING` mode is enabled using the following command:

```
SQL> ALTER DATABASE FORCE LOGGING;
```

- `STANDBY NOLOGGING FOR DATA AVAILABILITY` mode causes the load operation to send the loaded data to each standby through its own connection to the standby. The commit is delayed until all the standbys have applied the data as part of



running managed recovery in an Active Data Guard environment. It is enabled with the following command:

```
SQL> ALTER DATABASE SET STANDBY NOLOGGING FOR DATA AVAILABILITY;
```

- `STANDBY NOLOGGING FOR LOAD PERFORMANCE` is similar to the previous mode except that the loading process can stop sending the data to the standbys if the network cannot keep up with the speed at which data is being loaded to the primary. In this mode it is possible that the standbys may have missing data, but each standby automatically fetches the data from the primary as a normal part of running managed recovery in an Active Data Guard environment. It is enabled with the following command:

```
SQL> ALTER DATABASE SET STANDBY NOLOGGING FOR LOAD PERFORMANCE;
```

When you issue any of these statements, the primary database must at least be mounted (and it can also be open). The statement can take a considerable amount of time to complete, because it waits for all unlogged direct write I/O to finish.

#### Note:

When you enable `STANDBY NOLOGGING FOR DATA AVAILABILITY` or `STANDBY NOLOGGING FOR LOAD PERFORMANCE` on the primary database, any standbys that are using multi-instance redo apply functionality will stop applying redo with the error `ORA-10892`. You must first restart redo apply and allow the affected standbys to progress past the `NOLOGGING` operation period and then enable multi-instance redo apply.

#### See Also:

- *Oracle Database Administrator's Guide* for more information about the ramifications of specifying `FORCE LOGGING` mode

## 3.1.2 Configure Redo Transport Authentication

Oracle Data Guard uses Oracle Net sessions to transport redo data and control messages between the members of an Oracle Data Guard configuration.

These redo transport sessions are authenticated using either the Secure Sockets Layer (SSL) protocol or a remote login password file.

SSL is used to authenticate redo transport sessions between two databases if:

- The databases are members of the same Oracle Internet Directory (OID) enterprise domain and it allows the use of current user database links

- The `LOG_ARCHIVE_DEST_n`, and `FAL_SERVER` database initialization parameters that correspond to the databases use Oracle Net connect descriptors configured for SSL
- Each database has an Oracle wallet or supported hardware security module that contains a user certificate with a distinguished name (DN) that matches the DN in the OID entry for the database

If the SSL authentication requirements are not met, then each member of an Oracle Data Guard configuration must be configured to use a remote login password file and every physical standby database in the configuration must have an up-to-date copy of the password file from the primary database.

 **Note:**

As of Oracle Database 12c Release 2 (12.2.0.1) password file changes done on a primary database are automatically propagated to standby databases. The only exception to this is far sync instances. Updated password files must still be manually copied to far sync instances because far sync instances receive redo, but do not apply it. Once the password file is up-to-date at the far sync instance, the redo is automatically propagated to any standby databases that are set up to receive redo logs from that far sync instance. The password file is updated on the standby when the redo is applied.

 **See Also:**

- *Oracle Database Administrator's Guide* and *Oracle Database Reference* for more information about remote login password files
- *Oracle Database Security Guide* for more information about SSL
- *Oracle Database Net Services Administrator's Guide* for more information about Oracle Net Services

### 3.1.3 Configure the Primary Database to Receive Redo Data

It is a best practice to configure the primary database to receive redo if this is the first time a standby database is added to the configuration.

The primary database can then quickly transition to the standby role and begin receiving redo data, if necessary.

To create a standby redo log, use the SQL `ALTER DATABASE ADD STANDBY LOGFILE` statement. For example:

```
SQL> ALTER DATABASE ADD STANDBY LOGFILE ('/oracle/dbs/slog1.rdo') SIZE 500M;
```

```
SQL> ALTER DATABASE ADD STANDBY LOGFILE ('/oracle/dbs/slog2.rdo') SIZE 500M;
```

See [Configuring an Oracle Database to Receive Redo Data](#) for a discussion of how to determine the size of each log file and the number of log groups, as well as other background information about managing standby redo logs.

### 3.1.4 Set Primary Database Initialization Parameters

On the primary database, you define initialization parameters that control redo transport services while the database is in the primary role.

There are additional parameters you need to add that control the receipt of the redo data and apply services when the primary database is transitioned to the standby role.

The following example shows the primary role initialization parameters that you maintain on the primary database. This example represents an Oracle Data Guard configuration with a primary database located in Chicago and one physical standby database located in Boston. The parameters shown in this example are valid for the Chicago database when it is running in either the primary or the standby database role. The configuration examples use the names shown in the following table:

Database	DB_UNIQUE_NAME	Oracle Net Service Name
Primary	chicago	chicago
Physical standby	boston	boston

```
DB_NAME=chicago
DB_UNIQUE_NAME=chicago
LOG_ARCHIVE_CONFIG='DG_CONFIG=(chicago,boston) '
CONTROL_FILES='/arch1/chicago/control1.ctl', '/arch2/chicago/control2.ctl'
LOG_ARCHIVE_DEST_1=
  'LOCATION=USE_DB_RECOVERY_FILE_DEST
  VALID_FOR=(ALL_LOGFILES,ALL_ROLES)
  DB_UNIQUE_NAME=chicago'
LOG_ARCHIVE_DEST_2=
  'SERVICE=boston ASYNC
  VALID_FOR=(ONLINE_LOGFILES,PRIMARY_ROLE)
  DB_UNIQUE_NAME=boston'
REMOTE_LOGIN_PASSWORDFILE=EXCLUSIVE
LOG_ARCHIVE_FORMAT=%t_%s_%r.arc
```

These parameters control how redo transport services transmit redo data to the standby system and the archiving of redo data on the local file system. Note that the example specifies asynchronous (ASYNC) network transmission to transmit redo data on the LOG\_ARCHIVE\_DEST\_2 initialization parameter. These are the recommended settings and require standby redo log files (see [Configure the Primary Database to Receive Redo Data](#)).

The following shows the additional standby role initialization parameters on the primary database. These parameters take effect when the primary database is transitioned to the standby role.

```
FAL_SERVER=boston
DB_FILE_NAME_CONVERT='/boston/', '/chicago/'
LOG_FILE_NAME_CONVERT='/boston/', '/chicago/'
STANDBY_FILE_MANAGEMENT=AUTO
```

Specifying the initialization parameters shown above sets up the primary database to resolve gaps, converts new data file and log file path names from a new primary database, and archives the incoming redo data when this database is in the standby role. With the initialization parameters for both the primary and standby roles set as described, none of the parameters need to change after a role transition.

The following table provides a brief explanation about each parameter setting shown in the previous two examples.

Parameter	Recommended Setting
DB_NAME	On a primary database, specify the name used when the database was created. On a physical standby database, use the DB_NAME of the primary database.
DB_UNIQUE_NAME	Specify a unique name for each database. This name stays with the database and does not change, even if the primary and standby databases reverse roles.
LOG_ARCHIVE_CONFIG	The DG_CONFIG attribute of this parameter must be explicitly set on each database in an Oracle Data Guard configuration to enable full Oracle Data Guard functionality. Set DG_CONFIG to a text string that contains the DB_UNIQUE_NAME of each database in the configuration, with each name in this list separated by a comma.
CONTROL_FILES	Specify the path name for the control files on the primary database. It is recommended that a second copy of the control file is available so an instance can be easily restarted after copying the good control file to the location of the bad control file.
LOG_ARCHIVE_DEST_n	Specify where the redo data is to be archived on the primary and standby systems. <ul style="list-style-type: none"> <li>LOG_ARCHIVE_DEST_1 archives redo data generated by the primary database from the local online redo log files to the local archived redo log files in /arch1/chicago/.</li> <li>LOG_ARCHIVE_DEST_2 is valid only for the primary role. This destination transmits redo data to the remote physical standby destination boston.</li> </ul> <p><b>Note:</b> If a fast recovery area was configured (with the DB_RECOVERY_FILE_DEST initialization parameter) and you have not explicitly configured a local archiving destination with the LOCATION attribute, Oracle Data Guard automatically uses the LOG_ARCHIVE_DEST_1 initialization parameter (if it has not already been set) as the default destination for local archiving. Also, see <a href="#">LOG_ARCHIVE_DEST_n Parameter Attributes</a> for complete LOG_ARCHIVE_DEST_n information.</p>
REMOTE_LOGIN_PASSWORDFILE	This parameter must be set to EXCLUSIVE or SHARED if a remote login password file is used to authenticate administrative users or redo transport sessions.
LOG_ARCHIVE_FORMAT	Specify the format for the archived redo log files using a thread (%t), sequence number (%s), and resetlogs ID (%r).
FAL_SERVER	Specify the Oracle Net service name of the FAL server (typically this is the database running in the primary role). When the Chicago database is running in the standby role, it uses the Boston database as the FAL server from which to fetch (request) missing archived redo log files if Boston is unable to automatically send the missing log files.
DB_FILE_NAME_CONVERT	Specify the path name and filename location of the standby database data files followed by the primary location. This parameter converts the path names of the primary database data files to the standby data file path names. This parameter is used only to convert path names for physical standby databases. Multiple pairs of paths may be specified by this parameter.
LOG_FILE_NAME_CONVERT	Specify the location of the standby database online redo log files followed by the primary location. This parameter converts the path names of the primary database log files to the path names on the standby database. Multiple pairs of paths may be specified by this parameter.
STANDBY_FILE_MANAGEMENT	Set to AUTO so when data files are added to or dropped from the primary database, corresponding changes are made automatically to the standby database.

 **Note:**

Review the initialization parameter file for additional parameters that may need to be modified. For example, you may need to modify the dump destination parameters if the directory location on the standby database is different from those specified on the primary database.

## 3.1.5 Enable Archiving

If archiving is not enabled, then you must put the primary database in ARCHIVELOG mode and enable automatic archiving.

Issue the following SQL statements:

```
SQL> SHUTDOWN IMMEDIATE;  
SQL> STARTUP MOUNT;  
SQL> ALTER DATABASE ARCHIVELOG;  
SQL> ALTER DATABASE OPEN;
```

 **Note:**

The standby database must be in ARCHIVELOG mode for standby redo log archival to be performed.

See *Oracle Database Administrator's Guide* for information about archiving.

## 3.2 Step-by-Step Instructions for Creating a Physical Standby Database

These are the tasks you perform to create a physical standby database.

The information in this topic is written at a level of detail that requires you to already have a thorough understanding of the following topics:

- Database administrator authentication
- Database initialization parameters
- Managing redo logs, data files, and control files
- Managing archived redo logs
- Fast recovery areas
- Oracle Net configuration

[Table 3-1](#) provides a checklist of the tasks that you perform to create a physical standby database and the database or databases on which you perform each task.

**Table 3-1 Creating a Physical Standby Database**

Task	Database
Create a Backup Copy of the Primary Database Data Files	Primary
Create a Control File for the Standby Database	Primary
Create a Parameter File for the Standby Database	Primary
Copy Files from the Primary System to the Standby System	Primary
Set Up the Environment to Support the Standby Database	Standby
Start the Physical Standby Database	Standby
Verify the Physical Standby Database Is Performing Properly	Standby

### 3.2.1 Creating a Physical Standby Task 1: Create a Backup Copy of the Primary Database Data Files

You can use any backup copy of the primary database to create the physical standby database, as long as you have the necessary archived redo log files to completely recover the database.

You can use any backup copy of the primary database to create the physical standby database, as long as you have the necessary archived redo log files to completely recover the database. Oracle recommends that you use the Recovery Manager utility (RMAN).

See *Oracle Database Backup and Recovery User's Guide* for information about performing a database backup operation.

### 3.2.2 Creating a Physical Standby Task 2: Create a Control File for the Standby Database

Create the control file for the standby database (the primary database does not have to be open, but it must at least be mounted).

The following is an example of creating the control file for the standby database:

```
SQL> ALTER DATABASE CREATE STANDBY CONTROLFILE AS '/tmp/boston.ctl';
```

The `ALTER DATABASE` command designates the database that is to operate in the standby role; in this case, a database named `boston`.

You cannot use a single control file for both the primary and standby databases. They must each have their own file.

 **Note:**

If a control file backup is taken on the primary and restored on a standby (or vice versa), then the location of the snapshot control file on the restored system is configured to be the default. (The default value for the snapshot control file name is platform-specific and dependent on Oracle home.) Manually reconfigure it to the correct value using the RMAN CONFIGURE SNAPSHOT CONTROLFILE command.

### 3.2.3 Creating a Physical Standby Task 3: Create a Parameter File for the Standby Database

Create a parameter file (PFILE) from the server parameter file (SPFILE) used by the primary database.

Perform the following steps:

1. Issue a SQL statement such as the following:

```
SQL> CREATE PFILE='/tmp/initboston.ora' FROM SPFILE;
```

In [Set Up the Environment to Support the Standby Database](#), you then create a server parameter file from this parameter file, after it has been modified to contain parameter values appropriate for use at the physical standby database.

2. Modify the parameter values in the parameter file created in the previous step.

Although most of the initialization parameter settings in the parameter file are also appropriate for the physical standby database, some modifications must be made.

[Example 3-1](#) shows, in bold typeface, the parameters created earlier on the primary that must be changed.

#### Example 3-1 Modifying Initialization Parameters for a Physical Standby Database

```
.
.
.
DB_NAME=chicago
DB_UNIQUE_NAME=boston
LOG_ARCHIVE_CONFIG='DG_CONFIG=(chicago,boston)'  

CONTROL_FILES='/arch1/boston/control1.ctl', '/arch2/boston/control2.ctl'  

DB_FILE_NAME_CONVERT='/chicago/', '/boston/'  

LOG_FILE_NAME_CONVERT='/chicago/', '/boston/'  

LOG_ARCHIVE_FORMAT=log%t_%s_%r.arc  

LOG_ARCHIVE_DEST_1=  

  'LOCATION=USE_DB_RECOVERY_FILE_DEST  

  VALID_FOR=(ALL_LOGFILES,ALL_ROLES)  

  DB_UNIQUE_NAME=boston'  

LOG_ARCHIVE_DEST_2=  

  'SERVICE=chicago ASYNC  

  VALID_FOR=(ONLINE_LOGFILES,PRIMARY_ROLE)  

  DB_UNIQUE_NAME=chicago'  

REMOTE_LOGIN_PASSWORDFILE=EXCLUSIVE  

STANDBY_FILE_MANAGEMENT=AUTO  

FAL_SERVER=chicago
```

·  
·  
·

Ensure the `COMPATIBLE` initialization parameter is set to the same value on both the primary and standby databases. If the values differ, then redo transport services may be unable to transmit redo data from the primary database to the standby databases.

It is always a good practice to use the `SHOW PARAMETERS` command to verify no other parameters need to be changed.

The following table provides a brief explanation about the parameter settings shown in [Example 3-1](#) that have different settings from the primary database.

Parameter	Recommended Setting
<code>DB_UNIQUE_NAME</code>	Specify a unique name for this database. This name stays with the database and does not change even if the primary and standby databases reverse roles.
<code>CONTROL_FILES</code>	Specify the path name for the control files on the standby database. <a href="#">Example 3-1</a> shows how to do this for two control files. It is recommended that a second copy of the control file is available so an instance can be easily restarted after copying the good control file to the location of the bad control file.
<code>DB_FILE_NAME_CONVERT</code>	Specify the path name and filename location of the primary database data files followed by the standby location. This parameter converts the path names of the primary database data files to the standby data file path names.
<code>LOG_FILE_NAME_CONVERT</code>	Specify the location of the primary database online redo log files followed by the standby location. This parameter converts the path names of the primary database log files to the path names on the standby database.
<code>LOG_ARCHIVE_DEST_n</code>	Specify where the redo data is to be archived. In <a href="#">Example 3-1</a> : <ul style="list-style-type: none"> <li>• <code>LOG_ARCHIVE_DEST_1</code> archives redo data received from the primary database to archived redo log files in <code>/arch1/boston/</code>.</li> <li>• <code>LOG_ARCHIVE_DEST_2</code> is currently ignored because this destination is valid only for the primary role. If a switchover occurs and this instance becomes the primary database, then it transmits redo data to the remote Chicago destination.</li> </ul> <p><b>Note:</b> If a fast recovery area was configured (with the <code>DB_RECOVERY_FILE_DEST</code> initialization parameter) and you have not explicitly configured a local archiving destination with the <code>LOCATION</code> attribute, then Oracle Data Guard automatically uses the <code>LOG_ARCHIVE_DEST_1</code> initialization parameter (if it has not already been set) as the default destination for local archiving. Also, see <a href="#">LOG_ARCHIVE_DEST_n Parameter Attributes</a> for complete information about <code>LOG_ARCHIVE_DEST_n</code>.</p>
<code>FAL_SERVER</code>	Specify the Oracle Net service name of the FAL server (typically this is the database running in the primary role). When the Boston database is running in the standby role, it uses the Chicago database as the FAL server from which to fetch (request) missing archived redo log files if Chicago is unable to automatically send the missing log files.



 **Note:**

Review the initialization parameter file for additional parameters that may need to be modified. For example, you may need to modify the dump destination parameters if the directory location on the standby database is different from those specified on the primary database.

## 3.2.4 Creating a Physical Standby Task 4: Copy Files from the Primary System to the Standby System

Ensure that all required directories are created. Use an operating system copy utility to copy binary files from the primary system to their correct locations on the standby system.

The binary files to copy are as follows:

- Database backup created in [Create a Backup Copy of the Primary Database Data Files](#)
- Standby control file created in [Create a Control File for the Standby Database](#)
- Initialization parameter file created in [Create a Parameter File for the Standby Database](#)

## 3.2.5 Creating a Physical Standby Task 5: Set Up the Environment to Support the Standby Database

Set up the environment by creating a Windows-based service, a password file and an SPFILE, and setting up the Oracle Net environment.

Perform the following steps:

1. If the standby database is going to be hosted on a Windows system, then use the ORADIM utility to create a Windows service. For example:

```
oradim -NEW -SID boston -STARTMODE manual
```

The ORADIM utility automatically determines the username for which this service should be created and prompts for a password for that username (if that username needs a password). See *Oracle Database Platform Guide for Microsoft Windows* for more information about using the ORADIM utility.

2. Copy the remote login password file from the primary database system to the standby database system.

This step is optional if operating system authentication is used for administrative users and if SSL is used for redo transport authentication. If not, then copy the remote login password file from the primary database to the appropriate directory on the physical standby database system.

Any subsequent changes to the password file on the primary are automatically propagated to the standby. Changes to a password file can include when administrative privileges (SYSDBA, SYSOPER, SYSDBA, and so on) are granted or revoked, and when passwords of any user with administrative privileges is

changed. Updated password files must still be manually copied to far sync instances because far sync instances receive redo, but do not apply it. Once the password file is up-to-date at the far sync instance, the redo containing the password update at the primary is automatically propagated to any standby databases that are set up to receive redo from that far sync instance. The password file is updated on the standby when the redo is applied.

3. Configure and start a listener on the standby system if one is not already configured.

See *Oracle Database Net Services Administrator's Guide*.

4. Create Oracle Net service names.

On both the primary and standby systems, use Oracle Net Manager to create a network service name for the primary and standby databases that are to be used by redo transport services. The Net service names in this example are `chicago` and `boston`.

The Oracle Net service name must resolve to a connect descriptor that uses the same protocol, host address, port, and service that you specified when you configured the listeners for the primary and standby databases. The connect descriptor must also specify that a dedicated server be used.

See the *Oracle Database Net Services Administrator's Guide* for more information about service names.

5. On an idle standby database, use the SQL `CREATE` statement to create a server parameter file for the standby database from the text initialization parameter file that was edited in Task 3. For example:

```
SQL> CREATE SPFILE FROM PFILE='initboston.ora';
```

6. If the primary database has a database encryption wallet, then copy it to the standby database system and configure the standby database to use this wallet.

#### Note:

The database encryption wallet must be copied from the primary database system to each standby database system whenever the master encryption key is updated.

Encrypted data in a standby database cannot be accessed unless the standby database is configured to point to a database encryption wallet or hardware security module that contains the current master encryption key from the primary database.

## 3.2.6 Creating a Physical Standby Task 6: Start the Physical Standby Database

These are the steps to start the physical standby database and Redo Apply.

1. On the standby database, issue the following SQL statement to start and mount the database:

```
SQL> STARTUP MOUNT;
```

2. Restore the backup of the data files taken in [Create a Backup Copy of the Primary Database Data Files](#) and copied in [Copy Files from the Primary System to the Standby System](#) on the standby system.

3. On the standby database, issue the following command to start Redo Apply:

```
SQL> ALTER DATABASE RECOVER MANAGED STANDBY DATABASE -
> DISCONNECT FROM SESSION;
```

The statement includes the `DISCONNECT FROM SESSION` option so that Redo Apply runs in a background session.

### 3.2.7 Creating a Physical Standby Task 7: Verify the Physical Standby Database Is Performing Properly

After you create the physical standby database and set up redo transport services, you may want to verify database modifications are being successfully transmitted from the primary database to the standby database.

On the standby database, query the `V$DATAGUARD_PROCESS` view to verify that redo is being transmitted from the primary database and applied to the standby database.

```
SQL> SELECT ROLE, THREAD#, SEQUENCE#, ACTION FROM V$DATAGUARD_PROCESS;
```

ROLE	THREAD#	SEQUENCE#	ACTION
RFS ping	1	9	IDLE
recovery apply slave	0	0	IDLE
recovery apply slave	0	0	IDLE
managed recovery	0	0	IDLE
recovery logmerger	1	9	APPLYING_LOG
RFS archive	0	0	IDLE
RFS async	1	9	IDLE

The `recovery logmerger` role shows that redo is being applied at the standby.

#### Note:

Oracle recommends that you use the `V$DATAGUARD_PROCESS` view instead of the `V$MANAGED_STANDBY` view, which is deprecated as of Oracle Database 12c Release 2 (12.2.0.1) and may be desupported in a future release.

## 3.3 Creating a Physical Standby: Post-Creation Steps

After the physical standby database is running, you can upgrade the data protection mode, and you can enable Flashback Database.

- Upgrade the data protection mode  
[Oracle Data Guard Protection Modes](#) provides information about configuring the different data protection modes.

- Enable Flashback Database

Flashback Database removes the need to re-create the primary database after a failover. Flashback Database enables you to return a database to its state at a time in the recent past much faster than traditional point-in-time recovery, because it does not require restoring data files from backup nor the extensive application of redo data. You can enable Flashback Database on the primary database, the standby database, or both.

#### See Also:

- [Converting a Failed Primary Into a Standby Database Using Flashback Database and Using Flashback Database After Issuing an Open Resetlogs Statement](#) for scenarios showing how to use Flashback Database in an Oracle Data Guard environment
- *Oracle Database Backup and Recovery User's Guide* for more information about Flashback Database

## 3.4 Using DBCA to Create a Data Guard Standby

The Database Configuration Assistant (DBCA) can also be used as a simple command-line method to create an Oracle Data Guard physical standby database.

The DBCA command qualifier used to create the physical standby database is `createDuplicateDB`.

The basic `createDuplicateDB` command has the following syntax:

```
dbca -createDuplicateDB
     -gdbName global_database_name
     -primaryDBConnectionString easy_connect_string_to_primary
     -sid database_system_identifier
     [-createAsStandby
      [-dbUniqueName db_unique_name_for_standby]]
     [-customScripts scripts_list]
```

For more information about `createDuplicateDB` options, including the use of custom scripts, see *Oracle Database Administrator's Guide*.

In the following two examples the primary database is `chicago` and it resides on the primary system `myprimary.domain`. Each example creates a physical standby on the system on which the command is executed, `boston`. The `initParams` parameter is used in the examples to show how other DBCA parameters can be used in the standby creation command. In these examples, `initParams` is used to explicitly set the `INSTANCE_NAME` of the standby to match the `DB_UNIQUE_NAME`, `boston`.

This first example creates the standby database without any custom scripts being executed afterward.

```
dbca -silent -createDuplicateDB -primaryDBConnectionString
myprimary.domain:1523/chicago.domain
```

```
-gdbName chicago.domain -sid boston -initParams instance_name=boston -  
createAsStandby
```

```
Enter SYS user password:  
Listener config step  
33% complete  
Auxiliary instance creation  
66% complete  
RMAN duplicate  
100% complete  
Look at the log file " /u01/app/oracle/product/12.2.0/dbhome_1/  
cfgtoollogs/dbca/chicago/chicago.log" for further details.
```

The following example is exactly the same as the previous example, except that it runs a SQL script named `/tmp/test.sql` which can be used to perform post-creation operations.

```
dbca -silent -createDuplicateDB -primaryDBConnectionString  
myprimary.domain:1523/chicago.domain  
-gdbName chicago.domain -sid boston -initParams instance_name=boston -  
createAsStandby -customScripts /tmp/test.sql
```

```
Enter SYS user password:  
  
Listener config step  
25% complete  
Auxiliary instance creation  
50% complete  
RMAN duplicate  
75% complete  
Running Custom Scripts  
100% complete  
Look at the log file " /u01/app/oracle/product/12.2.0/dbhome_1/  
cfgtoollogs/dbca/chicago/chicago.log" for further details.
```

 **Note:**

Even though it is required to have a listener running on the physical standby system, it is not necessary to configure the Oracle Net service names for the databases on either system to execute these commands. In these examples, the Easy Connect naming method was used to create a connection to the primary database, `Chicago`, to complete creation of the standby, `Boston`. Before adding the new standby to the Data Guard configuration you would first configure Oracle Net service name descriptors on both systems, as described in Step 4 in [Creating a Physical Standby Task 5: Set Up the Environment to Support the Standby Database](#).

When these commands complete without any errors, the physical standby `Boston` is ready to be added to your Data Guard configuration. As part of adding it, you would need to define the Data Guard parameters in `Chicago` and `Boston` as shown

in [Creating a Physical Standby Task 3: Create a Parameter File for the Standby Database](#). Optionally, if you have an Oracle Data Guard broker configuration, you could use the broker `ADD DATABASE` command to add the new standby to your configuration (see *Oracle Data Guard Broker*).

## 3.5 Creating a Physical Standby of a CDB

You can create a physical standby of a multitenant container database (CDB) just as you can create a physical standby of a regular primary database.

The following are some of the behavioral differences to be aware of when you create and use a physical standby of a CDB:

- If you execute a switchover or failover operation, the entire CDB undergoes the role change. If you used the `ENABLED_PDBS_ON_STANDBY` initialization parameter, then be aware of the possibility that not every PDB is present in both the primary and the standby databases.
- The database role is defined at the CDB level, not at the individual container level.
- Any DDL related to role changes must be executed in the root container because a role is associated with an entire CDB. Individual pluggable databases (PDBs) do not have their own roles.
- In a physical standby of a CDB, the syntax of SQL statements is generally the same as for noncontainer databases. However, the effect of some statements, including the following, may be different:

- `ALTER DATABASE RECOVER MANAGED STANDBY` functions only in the root container; it is not allowed in a PDB.
- A role is associated with an entire CDB; individual PDBs do not have their own roles. Therefore, the following role change DDL associated with physical standbys affect the entire CDB:

```
ALTER DATABASE SWITCHOVER TO target_db_name
```

```
ALTER DATABASE ACTIVATE PHYSICAL STANDBY
```

- The `ALTER PLUGGABLE DATABASE [OPEN|CLOSE]` SQL statement is supported on the standby, provided you have already opened the root container.
- The `ALTER PLUGGABLE DATABASE RECOVER` statement is not supported on the standby. (Standby recovery is always at the CDB level.)
- To administer a multitenant environment, you must have the `CDB_DBA` role.
- Oracle recommends that the standby database have its own keystore.
- In a multitenant environment, the redo must be shipped to the root container of the standby database.

The following is an example of how to determine whether redo is being shipped to the root container. Suppose your primary database has the following settings:

```
LOG_ARCHIVE_DEST_2='SERVICE=boston ASYNC VALID_FOR=(ONLINE_LOGFILES,  
PRIMARY_ROLE) DB_UNIQUE_NAME=boston'
```

Redo is being shipped to `boston`. The container ID (`CON_ID`) for the root container is always 1, so you must make sure that the `CON_ID` is 1 for the service `boston`. To do this, check the service name in the `tnsnames.ora` file. For example:

```
boston = (DESCRIPTION=(ADDRESS=(PROTOCOL=tcp)(HOST=boston-server)(PORT=1521))
(CONNECT_DATA=(SERVICE_NAME=boston.us.example.com))
```

The service name for `boston` is `boston.us.example.com`.

On the standby database, query the `CDB_SERVICES` view to determine the `CON_ID`. For example:

```
SQL> SELECT NAME, CON_ID FROM CDB_SERVICES;
```

NAME	CON_ID
-----	-----
boston.us.example.com	1

The query result shows that the `CON_ID` for `boston` is 1.

#### See Also:

- *Oracle Database Concepts* for more information about CDBs
- *Oracle Database Advanced Security Guide* for more information about creating keystores

## 3.6 Creating a PDB in a Primary Database

In an Oracle Data Guard configuration, a pluggable database (PDB) on a primary database is created in the same way that a PDB on a regular database is created.

This topic lists key points about how Data Guard and the Oracle Multitenant option interact when any type of PDB creation is performed. For detailed information and examples, see My Oracle Support note 2049127.1 at <http://support.oracle.com>.

The steps to create a PDB on a regular database are documented in the *Oracle Multitenant Administrator's Guide*. Before following those steps, be sure to read the following:

- You can specify a subset of PDBs to be replicated on a physical standby of a multitenant container database (CDB). To do so, use the `ENABLED_PDBS_ON_STANDBY` initialization parameter to specify a list of PDBs or use the `STANDBYS` clause on the `CREATE PLUGGABLE DATABASE` statement, or both.

The `ENABLED_PDBS_ON_STANDBY` parameter (see `ENABLED_PDBS_ON_STANDBY`) is valid only on a physical standby; it is ignored by primary databases. (It can be set on a primary database for use if that database ever becomes a standby database.) It can be used to specify which PDBs should or should not be enabled on a physical standby database. If the parameter is not specified, then all PDBs in the CDB are created on the standby unless the `STANDBYS` clause is used.

The `STANDBYS` clause has no effect on whether recovery is later enabled or disabled. The `STANDBYS` clause of the SQL `CREATE PLUGGABLE DATABASE` statement has the following syntax:

```
CREATE PLUGGABLE DATABASE ... STANDBYS={('cdb_name', 'cdb_name', ...)
| NONE | ALL [EXCEPT ('cdb_name', 'cdb_name', ...)]}
```

- `cdb_name` is the `DB_UNIQUE_NAME` for the physical standbys in which the PDB is to be included.
- `NONE` excludes the PDB from being created in any of the standby CDBs. When a PDB is excluded from all standby CDBs, the PDB's data files are offline and marked as unnamed on all of the standby CDBs. Any new standby CDBs that are instantiated after the PDB has been created must disable the PDB for recovery explicitly to exclude it from the standby CDB. It is possible to enable a PDB on a standby CDB after it was excluded on that standby CDB.
- `ALL` (the default) includes the PDB being created in all standby CDBs.
- `EXCEPT cdb_name` includes the PDB being created in all standby CDBs except for those CDBs listed in this clause by their `DB_UNIQUE_NAME`.

When a list of CDB names is provided on the `STANDBYS` clause, the list must be enclosed in parentheses and each name must be enclosed within single quotation marks. The value of `DB_UNIQUE_NAME` can be up to 30 characters and is case insensitive. The following characters are valid in a database name: alphanumeric characters, underscore (`_`), number sign (`#`), and dollar sign (`$`).

The standbys in the list must be pre-populated with the required files unless the PDB is being created from seed, or a local clone with the standby running Active Data Guard, or a remote clone using the `STANDBY_PDB_SOURCE_FILE_DBLINK` parameter.

- When you create a PDB as a local clone from a different PDB or from the seed PDB within the same primary CDB, note the following:
  - When a new PDB is created from seed, the standby automatically instantiates the files.
  - In an Active Data Guard environment, when a PDB is cloned in the same CDB, Data Guard automatically instantiates the files.
  - In a non-Active Data Guard environment, when a PDB is cloned in the same CDB, use the `STANDBYS` clause on the `CREATE PLUGGABLE DATABASE` statement and enable recovery later.
- To automatically maintain standby databases when performing PDB remote clones or plugins, use the following initialization parameters:
  - `STANDBY_PDB_SOURCE_FILE_DBLINK`—For use with remote cloning. Specifies the name of the database link used to clone the PDB at the primary. When the redo for the PDB clone operation is applied at the standby, it uses that database link to connect to the source database to repeat the clone process to the destination standby database. This parameter is available only in Active Data Guard because it accesses the database dictionary for specific information about the link.

The source PDB for the cloning operation must be in read only mode for the duration of both the clone to the primary and the clone to the standby.



On remote clones that do *not* use the `STANDBY_PDB_SOURCE_FILE_DBLINK` parameter, the SQL `CREATE PLUGGABLE DATABASE` statement used to create the PDB must use the `STANDBYS=NONE` clause.

- `STANDBY_PDB_SOURCE_FILE_DIRECTORY`—For use with plugins. Specifies the directory location where files of a PDB being used for repeated plugins are stored. When the redo for the PDB plugin operation is applied at the standby, it searches the directory location for the data files and after finding them, copies them to the location the standby requires them to be based on the settings of the `DB_CREATE_FILE_DEST` and `DB_FILE_NAME_CONVERT` parameters.

 **Note:**

The files must be image copies of the source PDB data files. The copies should be created after creation of the manifest XML file for the source PDB.

These parameters should be reset after they have been used and are no longer needed. There is no runtime impact from setting and resetting these parameters because doing so does not require that instances be restarted.

See My Oracle Support note 2274735.1 at <http://support.oracle.com> for detailed information about using these parameters.

- To create a PDB from an XML file, copy the data files specified in the XML file to the standby database.

When a PDB is plugged into a primary database from an XML file, all standby databases in the configuration must be given access to the source PDB's files. (The only exceptions to this are standbys that have recovery deferred by use of either the `STANDBYS` clause on the `CREATE PLUGGABLE DATABASE` statement or the `ENABLED_PDBS_ON_STANDBY` initialization parameter.)

To provide standbys in the configuration with access to the source PDB's files, either use the `STANDBY_PDB_SOURCE_FILE_DIRECTORY` initialization parameter or copy the files of the source PDB to the standby site, typically the same set of PDB files that are to be plugged into the primary database. The files should be copied to the standby prior to the plugin operation being performed at the primary to minimize disruptions to managed standby recovery. Ensure the files are copied to the appropriate location at the standby where managed standby recovery can find them, as follows:

- If data files reside in standard operating system file systems, then the location of the files at the standby database are based on the value of the `DB_FILE_NAME_CONVERT` parameter. For more details about setting primary database initialization parameters, see [Set Primary Database Initialization Parameters](#)
- If data files reside in ASM, then use the `ASMCMD` utility to copy the files to the following location at the standby database:

```
db_create_file_dest/db_unique_name/GUID/datafile
```

The `GUID` parameter is the global unique identifier assigned to the PDB; once assigned, it does not change. To find the value of the `GUID` parameter, query the `V$CONTAINERS` view before unplugging the PDB from its original source

container. The following example shows how to find the value of the `GUID` parameter for the PDB whose PDB container ID in the source container is 3:

```
SELECT guid
   FROM V$CONTAINERS
  WHERE con_id=3;

GUID

D98C12257A951FC4E043B623F00A7AF5
```

In this example, if the value of the `DB_CREATE_FILE_DEST` parameter is `+DATAFILE` and the value of the `DB_UNIQUE_NAME` parameter is `BOSTON`, then the data files are copied to:

```
+DATAFILE/BOSTON/D98C12257A951FC4E043B623F00A7AF5/datafile
```

The path name of the data files on the standby database must be the same as the resultant path name when you create the PDB on the primary, unless the `DB_FILE_NAME_CONVERT` database initialization parameter has been configured on the standby. In that case, the path name of the data files on the standby database is the path name on the primary with `DB_FILE_NAME_CONVERT` applied.

#### See Also:

- *Oracle Database SQL Language Reference* for more information about the SQL statement `CREATE PLUGGABLE DATABASE`

# 4

## Creating a Logical Standby Database

There are a number of steps involved in creating a logical standby database, including prerequisites and post-creation tasks.

See the following topics for information about creating a logical standby database.

- [Prerequisite Conditions for Creating a Logical Standby Database](#)
- [Step-by-Step Instructions for Creating a Logical Standby Database](#)
- [Post-Creation Steps](#)
- [Creating a Logical Standby of a CDB](#)

### See Also:

- *Oracle Database Administrator's Guide* for information about creating and using server parameter files
- Oracle Enterprise Manager Cloud Control online help system for information about using the Oracle Data Guard broker graphical user interface (GUI) to automatically create a logical standby database.

### Note:

If you are working in a multitenant container database (CDB) environment, then see [Creating a Logical Standby of a CDB](#) for information about behavioral differences from non-CDB environments. For instance, in a CDB environment, many DBA views have analogous CDB views that you should use instead. For example, the view `CDB_LOGSTDBY_NOT_UNIQUE` contains the same data as shown in `DBA_LOGSTDBY_NOT_UNIQUE` view, but it has an additional column indicating the PDB name.

## 4.1 Prerequisite Conditions for Creating a Logical Standby Database

Before you create a logical standby database, you must first ensure the primary database is properly configured.

Perform the following tasks on the primary database to prepare for logical standby database creation:

- [Determine Support for Data Types and Storage Attributes for Tables](#)
- [Ensure Table Rows in the Primary Database Can Be Uniquely Identified](#)

A logical standby database uses standby redo logs (SRLs) for redo received from the primary database, and also writes to online redo logs (ORLs) as it applies changes to the standby database. Thus, logical standby databases often require additional `ARCn` processes to simultaneously archive SRLs and ORLs. Additionally, because archiving of ORLs takes precedence over archiving of SRLs, a greater number of SRLs may be needed on a logical standby during periods of very high workload.

**Note:**

Logical standby databases must be run in `ARCHIVELOG` mode for standby redo log archival to be performed.  
See *Oracle Database Administrator's Guide* for information about archiving.

### 4.1.1 Determine Support for Data Types and Storage Attributes for Tables

Before setting up a logical standby database, ensure the logical standby database can maintain the data types and tables in your primary database.

See [Unsupported Tables](#) for information about specific SQL queries you can use to determine if there are any unsupported data types or storage attributes.

### 4.1.2 Ensure Table Rows in the Primary Database Can Be Uniquely Identified

The ROWIDs contained in the redo records generated by the primary database cannot be used to identify the corresponding row in the logical standby database.

This is because the physical organization in a logical standby database is different from that of the primary database, even though the logical standby database is created from a backup copy of the primary database.

Oracle uses primary-key or unique-constraint/index supplemental logging to logically identify a modified row in the logical standby database. When database-wide primary-key and unique-constraint/index supplemental logging is enabled, each `UPDATE` statement also writes the column values necessary in the redo log to uniquely identify the modified row in the logical standby database.

- If a table has a primary key defined, then the primary key is logged along with the modified columns as part of the `UPDATE` statement to identify the modified row.
- In the absence of a primary key, the shortest nonnull unique-constraint/index is logged along with the modified columns as part of the `UPDATE` statement to identify the modified row.
- If there is no primary key and no nonnull unique constraint/index, then all columns with a declared maximum length of 4000 bytes are logged as part of the `UPDATE` statement to help identify the modified row. There are some requirements and restrictions with respect to supported data types. See the following sections for more information:

- [Supported Table Storage Types](#)

### – Unsupported Table Storage Types

- A function-based index, even though it is declared as unique, cannot be used to uniquely identify a modified row. However, logical standby databases support replication of tables that have function-based indexes defined, as long as modified rows can be uniquely identified.

Oracle recommends that you add a primary key or a nonnull unique index to tables in the primary database, whenever possible, to ensure that SQL Apply can efficiently apply redo data updates to the logical standby database.

Perform the following steps to ensure SQL Apply can uniquely identify rows of each table being replicated in the logical standby database.

1. Query the `DBA_LOGSTDBY_NOT_UNIQUE` view to display a list of tables that SQL Apply may not be able to uniquely identify. For example:

```
SQL> SELECT OWNER, TABLE_NAME FROM DBA_LOGSTDBY_NOT_UNIQUE
2> WHERE (OWNER, TABLE_NAME) NOT IN
3> (SELECT DISTINCT OWNER, TABLE_NAME FROM DBA_LOGSTDBY_UNSUPPORTED)
4> AND BAD_COLUMN = 'Y';
```

This query may take a few minutes to run.

2. If your application ensures the rows in a table are unique, then you can create a disabled primary key `RELY` constraint on the table. This avoids the overhead of maintaining a primary key on the primary database.

To create a disabled `RELY` constraint on a primary database table, use the `ALTER TABLE` statement with a `RELY DISABLE` clause. The following example creates a disabled `RELY` constraint on a table named `mytab`, for which rows can be uniquely identified using the `id` and `name` columns:

```
SQL> ALTER TABLE mytab ADD PRIMARY KEY (id, name) RELY DISABLE;
```

When you specify the `RELY` constraint, the system assumes that rows are unique. Because you are telling the system to rely on the information, but are not validating it on every modification done to the table, you must be careful to select columns for the disabled `RELY` constraint that uniquely identify each row in the table. If such uniqueness is not present, then SQL Apply does not correctly maintain the table.

To improve the performance of SQL Apply, add a unique-constraint/index to the columns to identify the row on the logical standby database. Failure to do so results in full table scans during `UPDATE` or `DELETE` statements carried out on the table by SQL Apply.

#### See Also:

- *Oracle Database Reference* for information about the `DBA_LOGSTDBY_NOT_UNIQUE` view
- *Oracle Database SQL Language Reference* for information about the `ALTER TABLE` statement syntax
- [Create a Primary Key RELY Constraint](#) for information about `RELY` constraints and actions you can take to increase performance on a logical standby database

## 4.2 Step-by-Step Instructions for Creating a Logical Standby Database

These are the tasks you perform to create a logical standby database.

**Table 4-1 Creating a Logical Standby Database**

Task	Database
<a href="#">Create a Physical Standby Database</a>	Primary
<a href="#">Stop Redo Apply on the Physical Standby Database</a>	Standby
<a href="#">Prepare the Primary Database to Support a Logical Standby Database</a>	Primary
<a href="#">Transition to a Logical Standby Database</a>	Standby
<a href="#">Open the Logical Standby Database</a>	Standby
<a href="#">Verify the Logical Standby Database Is Performing Properly</a>	Standby

### 4.2.1 Creating a Logical Standby Task 1: Create a Physical Standby Database

You create a logical standby database by first creating a physical standby database and then transitioning it to a logical standby database.

Follow the instructions in [Creating a Physical Standby Database](#) to create a physical standby database.

### 4.2.2 Creating a Logical Standby Task 2: Stop Redo Apply on the Physical Standby Database

You can run Redo Apply on the new physical standby database for any length of time before converting it to a logical standby database.

However, before converting to a logical standby database, stop Redo Apply on the physical standby database. Stopping Redo Apply is necessary to avoid applying changes past the redo that contains the LogMiner dictionary (described in [Build a Dictionary in the Redo Data](#)).

To stop Redo Apply, issue the following statement on the physical standby database:

```
SQL> ALTER DATABASE RECOVER MANAGED STANDBY DATABASE CANCEL;
```

### 4.2.3 Creating a Logical Standby Task 3: Prepare the Primary Database to Support a Logical Standby Database

As part of creating a logical standby database, you must prepare the primary database to support a logical standby.

See the following topics:

- [Prepare the Primary Database for Role Transitions](#)
- [Build a Dictionary in the Redo Data](#)

### 4.2.3.1 Prepare the Primary Database for Role Transitions

You may have to modify certain parameters when you prepare to switch the role of a primary database.

In [Set Primary Database Initialization Parameters](#), you set up several standby role initialization parameters to take effect when the primary database is transitioned to the *physical* standby role.

 **Note:**

This step is necessary only if you plan to perform switchovers.

If you plan to transition the primary database to the *logical* standby role, then you must also modify the parameters shown in bold typeface in [Example 4-1](#), so that no parameters need to change after a role transition:

- Change the `VALID_FOR` attribute in the original `LOG_ARCHIVE_DEST_1` destination to archive redo data only from the online redo log and not from the standby redo log.
- Include the `LOG_ARCHIVE_DEST_3` destination on the primary database. This parameter only takes effect when the primary database is transitioned to the logical standby role.

The following table describes the archival processing defined by the changed initialization parameters shown in [Example 4-1](#).

<code>LOG_ARCHIVE_DEST_n</code>	When the Chicago Database Is Running in the Primary Role	When the Chicago Database Is Running in the Logical Standby Role
<code>LOG_ARCHIVE_DEST_1</code>	Directs archiving of redo data generated by the primary database from the local online redo log files to the local archived redo log files in <code>/arch1/chicago/</code> .	Directs archiving of redo data generated by the logical standby database from the local online redo log files to the local archived redo log files in <code>/arch1/chicago/</code> .
<code>LOG_ARCHIVE_DEST_3</code>	Is ignored; <code>LOG_ARCHIVE_DEST_3</code> is valid only when <code>chicago</code> is running in the standby role.	Directs archiving of redo data from the standby redo log files to the local archived redo log files in <code>/arch2/chicago/</code> .

**Example 4-1 Primary Database: Logical Standby Role Initialization Parameters**

```
LOG_ARCHIVE_DEST_1=
  'LOCATION=/arch1/chicago/
  VALID_FOR=(ONLINE_LOGFILES, ALL_ROLES)
  DB_UNIQUE_NAME=chicago'
LOG_ARCHIVE_DEST_3=
  'LOCATION=/arch2/chicago/
  VALID_FOR=(STANDBY_LOGFILES, STANDBY_ROLE)
  DB_UNIQUE_NAME=chicago'
LOG_ARCHIVE_DEST_STATE_3=ENABLE
```

To dynamically set these initialization parameters, use the SQL `ALTER SYSTEM SET` statement and include the `SCOPE=BOTH` clause so that the changes take effect immediately and persist after the database is shut down and started up again.

### 4.2.3.2 Build a Dictionary in the Redo Data

A LogMiner dictionary must be built into the redo data so that the LogMiner component of SQL Apply can properly interpret changes it sees in the redo.

As part of building the LogMiner dictionary, supplemental logging is automatically set up to log primary key and unique-constraint/index columns. The supplemental logging information ensures each update contains enough information to logically identify each row that is modified by the statement.

To build the LogMiner dictionary, issue the following statement:

```
SQL> EXECUTE DBMS_LOGSTDBY.BUILD;
```

The `DBMS_LOGSTDBY.BUILD` procedure waits for all existing transactions to complete. Long-running transactions executed on the primary database affect the timeliness of this command.

#### Note:

In databases created using Oracle Database 11g Release 2 (11.2) or later, supplemental logging information is automatically propagated to any existing physical standby databases. However, for databases in earlier releases, or if the database was created using an earlier release and then upgraded to 11.2, you must check whether supplemental logging is enabled at the physical standby(s) if it is also enabled at the primary database. If it is not enabled at the physical standby(s), then before performing a switchover or failover, you must enable supplemental logging on all existing physical standby databases. To do so, issue the following SQL statement on each physical standby:

```
SQL> ALTER DATABASE ADD SUPPLEMENTAL LOG DATA (PRIMARY KEY, UNIQUE  
INDEX) COLUMNS;
```

If you do not do this, then any logical standby that is also in the same Oracle Data Guard configuration is unusable if a switchover or failover is performed to one of the physical standby databases. If a switchover or failover has already occurred and supplemental logging was not enabled, then you must recreate all logical standby databases.

#### See Also:

- The `DBMS_LOGSTDBY.BUILD` PL/SQL package in *Oracle Database PL/SQL Packages and Types Reference*
- The `UNDO_RETENTION` initialization parameter in *Oracle Database Reference*



## 4.2.4 Creating a Logical Standby Task 4: Transition to a Logical Standby Database

There are some necessary tasks you must perform to prepare the physical standby database to transition to a logical standby database.

The following topics describe these tasks:

- [Convert to a Logical Standby Database](#)
- [Adjust Initialization Parameters for the Logical Standby Database](#)

### 4.2.4.1 Convert to a Logical Standby Database

The redo logs contain the information necessary to convert your physical standby database to a logical standby database.

 **Note:**

If you have an Oracle RAC physical standby database, then shut down all but one instance, set `CLUSTER_DATABASE` to `FALSE`, and start the standby database as a single instance in `MOUNT EXCLUSIVE` mode, as follows:

```
SQL> ALTER SYSTEM SET CLUSTER_DATABASE=FALSE SCOPE=SPFILE;  
SQL> SHUTDOWN ABORT;  
SQL> STARTUP MOUNT EXCLUSIVE;
```

To continue applying redo data to the physical standby database until it is ready to convert to a logical standby database, issue the following SQL statement:

```
SQL> ALTER DATABASE RECOVER TO LOGICAL STANDBY db_name;
```

For *db\_name*, specify a database name that is different from the primary database to identify the new logical standby database. If you are using a server parameter file (spfile) at the time you issue this statement, then the database updates the file with appropriate information about the new logical standby database. If you are not using an spfile, then the database issues a message reminding you to set the name of the `DB_NAME` parameter after shutting down the database.

 **Note:**

If you are creating a logical standby database in the context of performing a rolling upgrade of Oracle software with a physical standby database, then issue the following command instead:

```
SQL> ALTER DATABASE RECOVER TO LOGICAL STANDBY KEEP IDENTITY;
```

A logical standby database created with the `KEEP IDENTITY` clause retains the same `DB_NAME` and `DBID` as that of its primary database. Such a logical standby database can only participate in one switchover operation, and thus should only be created in the context of a rolling upgrade with a physical standby database.

The `KEEP IDENTITY` clause is available only if the database being upgraded is running Oracle Database release 11.1 or later.

The statement waits, applying redo data until the LogMiner dictionary is found in the log files. This may take several minutes, depending on how long it takes redo generated in [Build a Dictionary in the Redo Data](#) to be transmitted to the standby database, and how much redo data needs to be applied. If a dictionary build is not successfully performed on the primary database, then this command never completes. You can cancel the SQL statement by issuing the `ALTER DATABASE RECOVER MANAGED STANDBY DATABASE CANCEL` statement from another SQL session.

 **Caution:**

In releases prior to Oracle Database 11g, you needed to create a new password file before you opened the logical standby database. This is no longer needed. Creating a new password file at the logical standby database causes redo transport services to not work properly.

## 4.2.4.2 Adjust Initialization Parameters for the Logical Standby Database

 **Note:**

If you started with an Oracle RAC physical standby database, then set `CLUSTER_DATABASE` back to `TRUE`, as follows:

```
SQL> ALTER SYSTEM SET CLUSTER_DATABASE=TRUE SCOPE=SPFILE;
```

On the logical standby database, shutdown the instance and issue the `STARTUP MOUNT` statement to start and mount the database. Do not open the database; it should remain closed to user access until later in the creation process. For example:

```
SQL> SHUTDOWN;  
SQL> STARTUP MOUNT;
```

You need to modify the `LOG_ARCHIVE_DEST_n` parameters because, unlike physical standby databases, logical standby databases are open databases that generate redo data and have multiple log files (online redo log files, archived redo log files, and standby redo log files). It is good practice to specify separate local destinations for:

- Archived redo log files that store redo data generated by the logical standby database. In [Example 4-2](#), this is configured as the `LOG_ARCHIVE_DEST_1=LOCATION=/arch1/boston` destination.
- Archived redo log files that store redo data received from the primary database. In [Example 4-2](#), this is configured as the `LOG_ARCHIVE_DEST_3=LOCATION=/arch2/boston` destination.

[Example 4-2](#) shows the initialization parameters that were modified for the logical standby database. The parameters shown are valid for the Boston logical standby database when it is running in either the primary or standby database role.

 **Note:**

If database compatibility is set to 11.1 or later, you can use the fast recovery area to store remote archived logs. To do this, you need to set only the following parameters (assuming you have already set the `DB_RECOVERY_FILE_DEST` and `DB_RECOVERY_FILE_DEST_SIZE` parameters):

```
LOG_ARCHIVE_DEST_1=
  'LOCATION=USE_DB_RECOVERY_FILE_DEST
  DB_UNIQUE_NAME=boston'
```

Because you are using the fast recovery area, it is not necessary to specify the `VALID_FOR` parameter. Its default value is `(ALL_LOGFILES,ALL_ROLES)` and that is the desired behavior in this case. `LOG_ARCHIVE_DEST_1` is used for all log files, both online (primary) and standby.

The following table describes the archival processing defined by the initialization parameters shown in [Example 4-2](#).

<code>LOG_ARCHIVE_DEST_n</code>	When the Boston Database Is Running in the Primary Role	When the Boston Database Is Running in the Logical Standby Role
<code>LOG_ARCHIVE_DEST_1</code>	Directs archival of redo data generated by the primary database from the local online redo log files to the local archived redo log files in <code>/arch1/boston/</code> .	Directs archival of redo data generated by the logical standby database from the local online redo log files to the local archived redo log files in <code>/arch1/boston/</code> .
<code>LOG_ARCHIVE_DEST_2</code>	Directs transmission of redo data to the remote logical standby database <code>chicago</code> .	Is ignored; <code>LOG_ARCHIVE_DEST_2</code> is valid only when <code>boston</code> is running in the primary role.
<code>LOG_ARCHIVE_DEST_3</code>	Is ignored; <code>LOG_ARCHIVE_DEST_3</code> is valid only when <code>boston</code> is running in the standby role.	Directs archival of redo data received from the primary database to the local archived redo log files in <code>/arch2/boston/</code> .

 **Note:**

The `DB_FILE_NAME_CONVERT` initialization parameter is not honored once a physical standby database is converted to a logical standby database. If necessary, register a skip handler and provide SQL Apply with a replacement DDL string to execute by converting the path names of the primary database data files to the standby data file path names. See the `DBMS_LOGSTDBY` package for information about the `SKIP` procedure.

**Example 4-2 Modifying Initialization Parameters for a Logical Standby Database**

```
LOG_ARCHIVE_DEST_1=
  'LOCATION=/arch1/boston/
  VALID_FOR=(ONLINE_LOGFILES,ALL_ROLES)
  DB_UNIQUE_NAME=boston'
LOG_ARCHIVE_DEST_2=
  'SERVICE=chicago ASYNC
  VALID_FOR=(ONLINE_LOGFILES,PRIMARY_ROLE)
  DB_UNIQUE_NAME=chicago'
LOG_ARCHIVE_DEST_3=
  'LOCATION=/arch2/boston/
  VALID_FOR=(STANDBY_LOGFILES,STANDBY_ROLE)
  DB_UNIQUE_NAME=boston'
LOG_ARCHIVE_DEST_STATE_1=ENABLE
LOG_ARCHIVE_DEST_STATE_2=ENABLE
LOG_ARCHIVE_DEST_STATE_3=ENABLE
```

## 4.2.5 Creating a Logical Standby Task 5: Open the Logical Standby Database

Use an `ALTER DATABASE SQL` statement to open the newly created logical standby.

For example, issue the following statement (do not supply the `RESETLOGS` option if the logical standby was created using the `KEEP IDENTITY` option):

```
SQL> ALTER DATABASE OPEN RESETLOGS;
```

 **Note:**

If you started with an Oracle RAC physical standby database, then you can start up all other standby instances at this point.

 **Caution:**

If you are co-locating the logical standby database on the same computer system as the primary database, then you must issue the following SQL statement before starting SQL Apply for the first time, so that SQL Apply skips the file operations performed at the primary database. The reason this is necessary is that SQL Apply has access to the same directory structure as the primary database, and data files that belong to the primary database could possibly be damaged if SQL Apply attempted to re-execute certain file-specific operations.

```
SQL> EXECUTE DBMS_LOGSTDBY.SKIP('ALTER TABLESPACE');
```

The `DB_FILENAME_CONVERT` parameter that you set up while co-locating the physical standby database on the same system as the primary database, is ignored by SQL Apply. See *Oracle Database PL/SQL Packages and Types Reference* for information about `DBMS_LOGSTDBY.SKIP` and equivalent behavior in the context of a logical standby database.

Because this is the first time the database is being opened, the database's global name is adjusted automatically to match the new `DB_NAME` initialization parameter. (This is not true if the logical standby was created using the `KEEP IDENTITY` option.)

 **Note:**

If you are creating the logical standby database to perform a rolling upgrade of the Oracle Database software, and you are concerned about updates to objects that may not be supported by SQL Apply, then Oracle recommends that you use the `DBMS_LOGSTDBY` PL/SQL procedure. At the logical standby database, run the following procedures to capture and record the information as events in the `DBA_LOGSTDBY_EVENTS` table:

```
EXEC DBMS_LOGSTDBY.APPLY_SET('MAX_EVENTS_RECORDED',  
DBMS_LOGSTDBY.MAX_EVENTS);
```

```
EXEC DBMS_LOGSTDBY.APPLY_SET('RECORD_UNsupported_OPERATIONS', 'TRUE');
```

This captures information about any transactions running on the primary that are not supported by logical standby. When the upgrade is complete and before you switch production to the new version, check this table. If nothing is recorded, then you know everything was replicated. If something is recorded, then you can choose to either take corrective action or abandon the upgrade.

**See Also:**

- [Customizing Logging of Events in the DBA\\_LOGSTDBY\\_EVENTS View](#) for more information about the `DBA_LOGSTDBY_EVENTS` view
- *Oracle Database PL/SQL Packages and Types Reference* for complete information about the `DBMS_LOGSTDBY` package

Issue the following statement to begin applying redo data to the logical standby database:

```
SQL> ALTER DATABASE START LOGICAL STANDBY APPLY IMMEDIATE;
```

## 4.2.6 Creating a Logical Standby Task 6: Verify the Logical Standby Database Is Performing Properly

After you create a logical standby database, it is important to verify that it is performing properly.

See the following topics:

- [Redo Transport Services](#)
- [Managing a Logical Standby Database](#)

## 4.3 Creating a Logical Standby: Post-Creation Steps

### Note:

The conversion of the physical standby database to a logical standby database happens in two phases:

1. As part of the `ALTER DATABASE RECOVER TO LOGICAL STANDBY` statement (unless you have specified the `KEEP IDENTITY` clause), the DBID of the database is changed.
2. As part of the first successful invocation of `ALTER DATABASE START LOGICAL STANDBY APPLY` statement, the control file is updated to make it consistent with that of the newly created logical standby database.

After you have successfully invoked the `ALTER DATABASE START LOGICAL STANDBY APPLY` statement, take a full backup of the logical standby database, because the backups taken from the primary database cannot be used to restore the logical standby database.

At this point, the logical standby database is running and can provide the maximum performance level of data protection. The following list describes additional preparations you can take on the logical standby database:

- Upgrade the data protection mode

The Oracle Data Guard configuration is initially set up in the maximum performance mode (the default).

- Enable Flashback Database

Flashback Database removes the need to re-create the primary database after a failover. Flashback Database enables you to return a database to its state at a time in the recent past much faster than traditional point-in-time recovery, because it does not require restoring data files from backup nor the extensive application of redo data. You can enable Flashback Database on the primary database, the standby database, or both.

 **See Also:**

- [Converting a Failed Primary Into a Standby Database Using Flashback Database and Using Flashback Database After Issuing an Open Resetlogs Statement](#) for scenarios showing how to use Flashback Database in an Oracle Data Guard environment.
- *Oracle Database Backup and Recovery User's Guide* for more information about Flashback Database

## 4.4 Creating a Logical Standby of a CDB

You can create a logical standby of a multitenant container database (CDB) just as you can create a logical standby of a regular primary database.

The following are some of the behavioral differences to be aware of when you create and use a logical standby of a CDB:

- The database role is defined at the CDB level, not at the pluggable database (PDB) container level.
- If you execute a switchover or failover operation, then the entire CDB undergoes the role change.
- Any DDL related to role changes must be executed while connected to the root container of the CDB.
- As with a regular logical standby, a logical standby of a CDB operates a single pool of processes that mine the redo stream once, but the responsibility is shared for updating all of the PDBs and the root container of the CDB.
- You are not required to have the same set of PDBs at the primary and standby. However, only tables that exist in the same container at both the primary and standby are replicated.
- In general, logical standby PL/SQL interfaces which modify global configuration attributes, such as `DBMS_LOGSTDBY.APPLY_SET`, are executed in the root container. However, `DBMS_LOGSTDBY.INSTANTIATE_TABLE` must be called inside the container where the table of interest resides, and the `DBMS_LOGSTDBY.SKIP` procedure must be called inside the container of interest.
- Logical standby views are enhanced to provide container names where appropriate. Many DBA views have analogous CDB views whose names begin with CDB. For example, the view `CDB_LOGSTDBY_NOT_UNIQUE` contains the same data as shown in `DBA_LOGSTDBY_NOT_UNIQUE` view, but it has an additional column indicating the PDB name. When the `CDB_LOGSTDBY_NOT_UNIQUE` view is queried in the root it shows data for all databases in the CDB.
- In a logical standby of a CDB, the syntax of SQL statements is generally the same as for noncontainer databases. However, the effect of some statements, including the following, may be different:
  - `ALTER DATABASE RECOVER TO LOGICAL STANDBY` functions only in the CDB; it is not allowed in a PDB.

- A role is associated with an entire CDB; individual PDBs do not have their own roles. Therefore, the following role change DDL associated with logical standbys affect the entire CDB:  

```
ALTER DATABASE [PREPARE|COMMIT] TO SWITCHOVER
```

```
ALTER DATABASE ACTIVATE LOGICAL STANDBY
```
- `ALTER DATABASE [START|STOP] LOGICAL STANDBY APPLY` functions only in the root container and affects the entire CDB. This statement is not allowed on a PDB.
- `ALTER DATABASE GUARD` functions only in the root container and affects the entire CDB. For example, if an `ALTER DATABASE GUARD ALL` statement is issued, then user activity in the root and in all PDBs is restricted.
- To administer a multitenant environment, you must have the `CDB_DBA` role.

 **See Also:**

- *Oracle Database Concepts* for more information about CDBs
- *Oracle Database PL/SQL Packages and Types Reference* for more information about using the `DBMS_LOGSTDBY.SKIP` procedure in containers



# 5

## Using Far Sync Instances

An Oracle Data Guard far sync instance is a remote Oracle Data Guard destination that accepts redo from the primary database and then ships that redo to other members of the Oracle Data Guard configuration.

A far sync instance manages a control file, receives redo into standby redo logs (SRLs), and archives those SRLs to local archived redo logs, but that is where the similarity with standbys ends. A far sync instance does not have user data files, cannot be opened for access, cannot run redo apply, and can never function in the primary role or be converted to any type of standby database.

Far sync instances are part of the Oracle Active Data Guard Far Sync feature, which requires an Oracle Active Data Guard license.

A far sync instance consumes very little disk and processing resources, yet provides the ability to failover to a terminal destination with zero data loss, as well as offload the primary database of other types of overhead (for example, redo transport).

All redo transport options available to a primary when servicing a typical standby destination are also available to it when servicing a far sync instance. And all redo transport options are available to a far sync instance when servicing terminal destinations (for example, performing redo transport compression, if you have a license for the Oracle Advanced Compression option).

Many configurations have a primary database shipping redo to a standby database using asynchronous transport at the risk of some data loss at failover time. Using synchronous redo transport to achieve zero data loss may not be a viable option because of the impact on the commit response times at the primary due to network latency between the two databases.

Creating a far sync instance close to the primary has the benefit of minimizing impact on commit response times to an acceptable threshold (due to the smaller network latency between primary and far sync instance) while allowing for higher data protection guarantees -- if the primary were to fail, and assuming the far sync instance was synchronized at the time of the failure, the far sync instance and the terminal standby would coordinate a final redo shipment from the far sync instance to the standby to ship any redo not yet available to the standby and then perform a zero-data-loss failover.

See the following topics:

- [Creating a Far Sync Instance](#)
- [Alternate Destinations](#)
- [Configuring Alternate Destinations](#)
- [Supported Protection Modes for Far Sync Instances](#)

## 5.1 Creating a Far Sync Instance

Creating a far sync instance is similar to creating a physical standby except that data files do not exist at the far sync instance.

Therefore, on a far sync instance there is no need to copy data files or restore data files from a backup. Once the far sync instance has been created, the configuration is modified to send redo synchronously from the primary database to the far sync instance in Maximum Availability mode and the far sync instance then forwards the redo asynchronously in real time. Lastly, the original asynchronous standby (referred to as the terminal standby) is configured to act as the alternate to the far sync instance in the event that communication with the far sync instance is interrupted.

### Note:

In a configuration that contains a far sync instance, there must still be a direct network connection between the primary database and the remote standby database. The direct connection between the primary and the remote standby is used to perform health checks and switchover processing tasks. It is not used for redo transport unless the standby has been configured as an alternate destination in case the far sync instance fails and there is no alternate far sync configured to maintain the protection level.

### 5.1.1 Creating and Configuring a Far Sync Instance

Take the following steps to create a far sync instance:

1. Create the control file for the far sync instance, as shown in the following example (the primary database does not have to be open, but it must at least be mounted):

```
SQL> ALTER DATABASE CREATE FAR SYNC INSTANCE CONTROLFILE AS -  
> '/arch2/chicagoFS/control01.ctl';
```

The resulting control file enables `chicagoFS` to operate as a far sync instance that receives redo from primary database `chicago`. The path and file name shown are just an example; you could use any path or file name that you want.

2. Create a parameter file (PFILE) from the server parameter file (SPFILE) used by the primary database. Although most of the initialization settings in the parameter file are also appropriate for the far sync instance, some modifications must be made. For example, on a far sync instance, the `DB_FILE_NAME_CONVERT` and `LOG_FILE_NAME_CONVERT` parameters must be set, and the `DB_UNIQUE_NAME` of the far sync instance and the location of the far sync instance control file must be modified. [Example 5-1](#) shows sample parameter file content for a far sync instance with a `DB_UNIQUE_NAME` of `chicagoFS`.
3. Create a server parameter file (SPFILE) from the edited parameter file (PFILE) to facilitate any subsequent changes to parameter values. If you do not use an SPFILE, then a warning is returned in the `SHOW CONFIGURATION` output when the far sync instance is added to an Oracle Data Guard broker configuration.

4. Use an operating system copy utility to copy the far sync instance control file created in Step 1 and the server parameter file (SPFILE) created in Step 3 from the primary system to the appropriate locations on the far sync instance system.
5. Create standby redo logs in the same way they are created for a regular standby. See [Managing Standby Redo Logs](#).

Because the `LOG_FILE_NAME_CONVERT` parameter was specified on the far sync instance (see [Example 5-1](#)), the standby redo logs are created automatically when redo transport begins from the primary, if they were created on the primary as described in [Configure the Primary Database to Receive Redo Data](#).

 **Note:**

Standby redo log files used at the far sync instance cannot be shared with other databases. Therefore, all relevant considerations discussed in [Standby Database Directory Structure Considerations](#) for standby redo log files also apply at the far sync instance.

6. If the far sync instance is to be hosted on a Windows system, use the ORADIM utility to create a Windows service. For example:

```
oradim -NEW -SID ChicagoFS -STARTMODE manual
```

After the far sync instance is created and running you can change the `STARTMODE` to `auto` to enable automatic startup of the far sync instance

The ORADIM utility automatically determines the username for which this service should be created and prompts for a password for that username (if that username needs a password). See *Oracle Database Platform Guide for Microsoft Windows* for more information about using the ORADIM utility.

7. This step is optional if operating system authentication is used for administrative users and if SSL is used for redo transport authentication. If not, then copy the primary database's remote login password file to the appropriate directory on the far sync instance. The password file must be recopied whenever an administrative privilege (`SYSDG`, `SYSOPER`, `SYSDBA`, and so on) is granted or revoked, and after the password of any user with administrative privileges is changed.

As of Oracle Database 12c Release 2 (12.2.0.1), when a password file is manually updated at a far sync instance, the redo containing the same password changes from the primary database is automatically propagated to any standby databases that are set up to receive redo from that far sync instance. The password file is updated on the standby when the redo is applied.

8. On the far sync instance site, use Oracle Net Manager to configure a listener for the far sync instance.

See *Oracle Database Net Services Administrator's Guide* for more information about the listener.

9. On the primary system, use Oracle Net Manager to create a network service name for the far sync instance (`chicagoFS`) that is to be used by redo transport services.

On the far sync instance system, use Oracle Net Manager to create a network service name for the primary (`chicago`) and the terminal standby (`boston`) to be used by redo transport services.

The Oracle Net service name must resolve to a connect descriptor that uses the same protocol, host address, port, and service that you specified when you configured the listeners for the primary database, the far sync instance, and the terminal standby database. The connect descriptor must also specify that a dedicated server be used.

See the *Oracle Database Net Services Administrator's Guide* for more information about service names.

10. Start the far sync instance in mount mode.

11. Verify that the far sync instance is operating properly.

For information about validating a configuration after you create a far sync instance, see [Validating a Configuration](#).

12. Increase the protection mode of the configuration to Maximum Availability. On the primary database, execute the following command:

```
SQL> ALTER DATABASE SET STANDBY TO MAXIMIZE AVAILABILITY;
```

#### See Also:

- [Supported Protection Modes for Far Sync Instances](#) for more information about far sync and protection modes
- [Oracle Data Guard Protection Modes](#) for more information about configuring different data protection modes

### Example 5-1 Some of the Initialization Parameters Used for Far Sync Instances

#### Primary Database chicago

```
DB_UNIQUE_NAME=chicago

CONTROL_FILES='/arch1/chicago/control01.ctl'

DB_FILE_NAME_CONVERT='/boston/', '/chicago/'

LOG_FILE_NAME_CONVERT='/boston/', '/chicago/'

FAL_SERVER=boston

LOG_ARCHIVE_CONFIG='DG_CONFIG=(chicago,chicagoFS,boston)'

LOG_ARCHIVE_DEST_1='LOCATION=USE_DB_RECOVERY_FILE_DEST
VALID_FOR=(ALL_LOGFILES,ALL_ROLES) DB_UNIQUE_NAME=chicago'

LOG_ARCHIVE_DEST_2='SERVICE=chicagoFS SYNC AFFIRM
VALID_FOR=(ONLINE_LOGFILES,PRIMARY_ROLE) DB_UNIQUE_NAME=chicagoFS'
```

#### Far Sync Instance chicagoFS

```
DB_UNIQUE_NAME=chicagoFS

CONTROL_FILES='/arch2/chicagoFS/control01.ctl'

DB_FILE_NAME_CONVERT='/chicago/', '/chicagoFS/', '/boston/', '/chicagoFS/'

LOG_FILE_NAME_CONVERT='/chicago/', '/chicagoFS/', '/boston/', '/chicagoFS/'
```

```
FAL_SERVER=chicago

LOG_ARCHIVE_CONFIG='DG_CONFIG=(chicago,chicagoFS,boston) '

LOG_ARCHIVE_DEST_1='LOCATION= USE_DB_RECOVERY_FILE_DEST
VALID_FOR=(ALL_LOGFILES,ALL_ROLES) DB_UNIQUE_NAME=chicagoFS '

LOG_ARCHIVE_DEST_2='SERVICE=boston ASYNC
VALID_FOR=(STANDBY_LOGFILES,STANDBY_ROLE) DB_UNIQUE_NAME=boston '
```

### Physical Standby boston

```
DB_UNIQUE_NAME=boston

CONTROL_FILES='/arch3/boston/control01.ctl'

DB_FILE_NAME_CONVERT='/chicago/', '/boston/'

LOG_FILE_NAME_CONVERT='/chicago/', '/boston/'

FAL_SERVER='chicagoFS', 'chicago'

LOG_ARCHIVE_CONFIG='DG_CONFIG=(chicago,chicagoFS,boston) '

LOG_ARCHIVE_DEST_1='LOCATION= USE_DB_RECOVERY_FILE_DEST
VALID_FOR=(ALL_LOGFILES,ALL_ROLES) DB_UNIQUE_NAME=boston '

LOG_ARCHIVE_DEST_2='SERVICE=chicago ASYNC
VALID_FOR=(ONLINE_LOGFILES,PRIMARY_ROLE) DB_UNIQUE_NAME=chicago '
```

## 5.2 Alternate Destinations

After you perform the steps in [Creating and Configuring a Far Sync Instance](#), the far sync instance provides zero data loss capability for the configuration by forwarding the redo to the terminal standby at a remote site over the WAN. For the configuration to remain protected in the event the far sync instance is not reachable, you must configure alternate redo transport paths to the standby databases. This is accomplished using the `GROUP` and `PRIORITY` attributes of the `LOG_ARCHIVE_DEST_n` parameter. (As of Oracle Database 12c Release 2 (12.2.0.1), the `GROUP` and `PRIORITY` attributes have replaced the `ALTERNATE` attribute for remote redo destinations.)

The number of possible alternate remote destinations has been increased with the concept of log archive destination groups. A log archive destination group specifies multiple archive destinations that can be used to distribute redo to multiple destinations, either from a far sync instance or through cascading. The destinations in the group can then be prioritized so that only one destination is active at a time on the primary database. Other destinations are available to become active if the active destination becomes unavailable. To expand the number of possible archive destinations for your database, you can specify multiple groups.

 **See Also:**

- [Using the ALTERNATE Attribute to Configure Remote Alternate Destinations](#) for information about configuring alternate remote destinations using the old ALTERNATE syntax.

## 5.2.1 Assigning Log Archive Destinations to a Group

Use the `GROUP` attribute of the `LOG_ARCHIVE_DEST_n` initialization parameter to assign log archive destinations to groups.

If log archive destination groups are used, then as long as at least one destination within the group remains available, at least one destination remains enabled and active. Log archive destinations that are not assigned to a group behave the same as log archive destinations did prior to Oracle Database 12c Release 2 (12.2.0.1).

There can be up to 30 log archive destinations in a group. Log archive destination groups are referenced by their group number, which is assigned when the group is created. Groups are numbered from 1 through 8. A log archive destination group contains a set of remote (`SERVICE=...`) destinations. (Local archival (`LOCATION=...`) destinations are not supported in log archive destination groups and must use the `ALTERNATE` attribute for alternate local archiving locations. See [ALTERNATE](#).

One log archive destination in the group is always active and the others are available for use in the event of a failure of the active log archive destination. When a failed destination again becomes available it becomes eligible if the currently active destination fails, but it does not become active immediately, unless all other group members are also unavailable. For example, the following declaration can be used to specify three far sync instances as members of the same group and having the same priority (Priority within a group is described in the next section). These are example parameter definitions and do not contain all the necessary attributes. Do not use them verbatim. In this example only the first destination is active with the second destination available to take over if destination 1 becomes unavailable.

```
LOG_ARCHIVE_DEST_2='SERVICE=chicagoFS SYNC  
VALID_FOR=(ONLINE_LOGFILES,PRIMARY_ROLE) GROUP=1'
```

```
LOG_ARCHIVE_DEST_STATE_2=ENABLE
```

```
LOG_ARCHIVE_DEST_3='SERVICE=chicagoFS1 SYNC  
VALID_FOR=(ONLINE_LOGFILES,PRIMARY_ROLE) GROUP=1'
```

```
LOG_ARCHIVE_DEST_STATE_3=ALTERNATE
```

 **Note:**

Because log archive destination groups replace the `LOG_ARCHIVE_DEST_n` `ALTERNATE` attribute, use of the `ALTERNATE` attribute with log archive destinations that are not in the default group (where `GROUP` is specified as 1 to 8) is not allowed.

## 5.2.2 Assigning Priorities to Log Archive Destinations in a Group

Using the `PRIORITY` attribute of the `LOG_ARCHIVE_DEST_n` initialization parameter to assign destination preferences within a log archive destination group allows you to control the fail back mechanism, especially with multiple members within a group.

In the previous section, the two far sync instance destinations did not have a priority, which means that when the alternate destination is activated after a failure of the first destination it remains as the active destination until it fails. The priority is used to determine which log archive destination within a group to make active when the database or far sync instance is started or when a destination fails. Log archive destinations become active in the following cases: The primary database is opened in read/write mode, a far sync instance is mounted, or a standby database is mounted or opened in read-only mode. The same priority value can be assigned to more than one log archive destination in a group. The priority value is an integer in the range of 1 through 8. Lower numbers indicate higher priorities. The default priority is 1 (the highest priority).

The priority comes into play when a previously failed destination becomes available again. A set of log archive destinations assigned to the same group have the same priority, by default. Therefore, if one destination fails then a failover occurs to another member of the set. When the failed destination becomes available again, it does not become the active destination since both destinations have the same priority. If the second destination fails after the first destination has again become available, then the database fails over to the first destination or to another destination in the group at the same priority. This cycle can repeat indefinitely, provided that another destination is always available before the active destination fails.

Continuing with the previous example, priorities can be added to the log archive destinations to control when a destination might become active. In the following example, a third far sync instance is added, but at a lower priority:

```
LOG_ARCHIVE_DEST_2='SERVICE=chicagoFS SYNC
VALID_FOR=(ONLINE_LOGFILES,PRIMARY_ROLE) GROUP=1 PRIORITY=1'

LOG_ARCHIVE_DEST_STATE_2=ENABLE

LOG_ARCHIVE_DEST_3='SERVICE=chicagoFS1 SYNC
VALID_FOR=(ONLINE_LOGFILES,PRIMARY_ROLE) GROUP=1 PRIORITY=1'

LOG_ARCHIVE_DEST_STATE_3=ALTERNATE

LOG_ARCHIVE_DEST_4='SERVICE=chicagoFS2 ASYNC
VALID_FOR=(ONLINE_LOGFILES,PRIMARY_ROLE) GROUP=1 PRIORITY=2'

LOG_ARCHIVE_DEST_STATE_4=ALTERNATE
```

This declaration results in the following behavior:

- The primary ships redo to the first of two preferred far sync instances, `chicagoFS`
- If `chicagoFS` become unavailable, then the primary ships to `chicagoFS1`.
- If `chicagoFS` becomes available again, no fail back occurs. It becomes the alternate to `chicagoFS1` because the priority is the same.

- If both `chicagoFS` and `chicagoFS1` become unavailable, then the primary ships to `chicagoFS2` (in this case via the `ASync` redo transmission mode).
- If either `chicagoFS` or `chicagoFS1` become available while the primary is shipping to `chicagoFS2`, then the primary fails back to that available preferred log archive destination.

## 5.2.3 Shipping to Multiple Active Destinations in a Group

You can also use the `PRIORITY` attribute to configure a group so that it ships to multiple destinations if a preferred destination fails.

The mechanism that supports multiple active destinations within a single group is that the lowest priority (`PRIORITY=8`) is defined to activate destinations within that group at that priority, generally used to send the redo directly to the target standby databases. The following log archive destination declaration shows how this could be configured. In this example, there is one far sync instance that forwards redo to two terminal standby databases:

```
LOG_ARCHIVE_DEST_2='SERVICE=chicagoFS SYNC
VALID_FOR=(ONLINE_LOGFILES,PRIMARY_ROLE) GROUP=1 PRIORITY=1'

LOG_ARCHIVE_DEST_STATE_2=ENABLE

LOG_ARCHIVE_DEST_3='SERVICE=boston ASYNC
VALID_FOR=(ONLINE_LOGFILES,PRIMARY_ROLE) GROUP=1 PRIORITY=8'

LOG_ARCHIVE_DEST_STATE_3=ALTERNATE

LOG_ARCHIVE_DEST_4='SERVICE=newyork ASYNC
VALID_FOR=(ONLINE_LOGFILES,PRIMARY_ROLE) GROUP=1 PRIORITY=8'

LOG_ARCHIVE_DEST_STATE_4=ALTERNATE
```

This declaration results in the following behavior:

- The primary ships redo to the preferred far sync instance, `chicagoFS`.
- If `chicagoFS` is unavailable, then the primary ships directly to both terminal standbys `boston` and `newyork` in `ASync` mode.
- While shipping to `boston` and `newyork`, if `chicagoFS` becomes available, then the primary stops shipping directly to `boston` and `newyork` and begins shipping instead to `chicagoFS`.

## 5.2.4 Using Multiple Log Archive Destination Groups

Multiple log archive destination groups can be used for site-specific high availability considerations or to distribute service over large cascaded (reader farm) configurations.



The following declaration sets up multiple log archive destination groups with `chicagoFS` and `chicagoFS1` in group 1 and `chicagoFS3` and `chicagoFS4` in group 2:

```
LOG_ARCHIVE_DEST_2='SERVICE=chicagoFS SYNC
VALID_FOR=(ONLINE_LOGFILES,PRIMARY_ROLE) GROUP=1 PRIORITY=1'

LOG_ARCHIVE_DEST_STATE_2=ENABLE

LOG_ARCHIVE_DEST_3='SERVICE=chicagoFS1 SYNC
VALID_FOR=(ONLINE_LOGFILES,PRIMARY_ROLE) GROUP=1 PRIORITY=1'

LOG_ARCHIVE_DEST_STATE_3=ALTERNATE

LOG_ARCHIVE_DEST_4='SERVICE=chicagoFS3 SYNC
VALID_FOR=(ONLINE_LOGFILES,PRIMARY_ROLE) GROUP=2 PRIORITY=1'

LOG_ARCHIVE_DEST_STATE_4=ENABLE

LOG_ARCHIVE_DEST_5='SERVICE=chicagoFS4 SYNC
VALID_FOR=(ONLINE_LOGFILES,PRIMARY_ROLE) GROUP=2 PRIORITY=1'

LOG_ARCHIVE_DEST_STATE_5=ALTERNATE
```

## 5.2.5 Determining the Availability Status of Log Archive Destinations

Oracle Data Guard keeps track of the current status of available but inactive destinations in log archive destination groups by periodically polling configured destinations to determine their availability.

The information used to determine availability is derived from the `MAX_FAILURE` attribute which specifies the consecutive number of times redo transport services attempt to reestablish communication and transmit redo data to a failed destination before the primary database gives up on the destination. The default value for `MAX_FAILURE` is 1 when the `GROUP` and `PRIORITY` attributes are used.

The behavior of the `MAX_FAILURE` attribute is different between Oracle Database 12c Release 1 (12.1) and Oracle Database 12c Release 2 (12.2). It is important to understand the differences.

### See Also:

- [MAX\\_FAILURE](#)

## 5.3 Configuring Alternate Destinations

Far sync instance configurations can be set up to provide varying levels of data protection.

The following topics expand on the examples provided in the previous section and provide examples of two additional far sync instance configurations that provide better data protection when you use far sync instances.

- [Reduced Protection After a Far Sync Failure](#)
- [Far Sync Instance High Availability](#)
- [Maintaining Protection After a Role Change](#)

### 5.3.1 Reduced Protection After a Far Sync Failure

With all far sync instance configurations it is important that redo continues to ship to the terminal standbys to continue to provide protection of the primary database.

In the simplest configuration there is one far sync instance (`chicagoFS`) and one terminal standby database (`boston`).

If the far sync instance fails, then redo should be shipped directly to the terminal standby by adding an additional log archive destination to the primary database, `chicago`. This does reduce the protection level because redo transmission is then in `ASYN`C mode instead of `SYN`C mode.

#### Example 5-2 Configuring for Single Destination Failover

##### Primary Database `chicago`

```
LOG_ARCHIVE_DEST_2='SERVICE=chicagoFS SYNC AFFIRM
VALID_FOR=(ONLINE_LOGFILES,PRIMARY_ROLE) DB_UNIQUE_NAME=chicagoFS
GROUP=1 PRIORITY=1'

LOG_ARCHIVE_DEST_STATE_2=ENABLE

LOG_ARCHIVE_DEST_3='SERVICE=boston ASYNC NOAFFIRM
VALID_FOR=(ONLINE_LOGFILES,PRIMARY_ROLE) DB_UNIQUE_NAME=boston GROUP=1
PRIORITY=2'

LOG_ARCHIVE_DEST_STATE_3=ALTERNATE
```

This declaration causes the primary database to ship redo directly to the terminal standby if the far sync instance `chicagoFS` fails. If the far sync instance becomes available again, then it becomes the active destination and redo transmission goes to the far sync instance.

If the far sync instance had multiple terminal standby databases, then you would use `PRIORITY=8` to ensure that all of those destinations received redo directly from the primary database if the far sync instance failed.

#### Example 5-3 Configuring for Multiple Standby Database Redo Destination Failover

##### Primary Database `chicago`

As in the previous example, modify the log archive destination on the primary database for the far sync instance to add it to a group with a Priority of 1 and then

add a new log archive destination for each standby the far sync instance services at Priority 8 in ASYNC mode.

```
LOG_ARCHIVE_DEST_2='SERVICE=chicagoFS SYNC AFFIRM
VALID_FOR=(ONLINE_LOGFILES,PRIMARY_ROLE) DB_UNIQUE_NAME=chicagoFS
GROUP=1 PRIORITY=1'

LOG_ARCHIVE_DEST_STATE_2=ENABLE

LOG_ARCHIVE_DEST_3='SERVICE=boston ASYNC NOAFFIRM
VALID_FOR=(ONLINE_LOGFILES,PRIMARY_ROLE) DB_UNIQUE_NAME=boston GROUP=1
PRIORITY=8'

LOG_ARCHIVE_DEST_STATE_3=ALTERNATE

LOG_ARCHIVE_DEST_4='SERVICE=newyork ASYNC NOAFFIRM
VALID_FOR=(ONLINE_LOGFILES,PRIMARY_ROLE) DB_UNIQUE_NAME=newyork GROUP=1
PRIORITY=8'

LOG_ARCHIVE_DEST_STATE_3=ALTERNATE
```

This declaration causes the primary database to ship redo directly to both terminal standby databases if the far sync instance `chicagoFS` fails. If the far sync instance becomes available again, then it becomes the active destination and redo transmission goes to the far sync instance.

## 5.3.2 Far Sync Instance High Availability

Configuring an alternate far sync instance keeps the protection level of the configuration at the configured protection level of Maximum Availability if the preferred far sync instance fails for some reason.

In both of the preceding examples the protection level of the configuration would fall out of Maximum Availability because redo is no longer being shipped in `SYNC` mode. For more protection from system or network failures, an additional far sync instance can be configured that provides high availability for the active far sync instance. In this configuration one is the preferred active far sync instance and the other is the alternate far sync instance.

The primary automatically starts shipping to the alternate far sync instance if it detects a failure at the preferred far sync instance. In these types of configurations, the primary uses only one far sync instance to redistribute redo at any given time.

To maintain the Maximum Availability protection level, configure two far sync instances near to the primary database and set them up to protect each other. Then, if the active far sync instance becomes unavailable, the primary database can automatically begin sending redo in synchronous mode to the alternate far sync instance, thereby maintaining the elevated protection level of Maximum Availability. In this case though, the two far sync instances have the same priority and when one takes over for the other it remains the active far sync instance until it fails. To ensure that redo continues to be shipped to the terminal standby database in the event that both far sync instances fail, the terminal standby database is configured as before with `PRIORITY=2`. (If there is more than one terminal standby database, then use `PRIORITY=8` for them).

The high availability far sync instance would be created using the same steps as given in [Creating and Configuring a Far Sync Instance](#), and configured to forward redo to the terminal standby `boston`.

#### Example 5-4 Parameters Used to Set Up the High Availability Far Sync Instance

##### Primary Database `chicago`

```
LOG_ARCHIVE_CONFIG='DG_CONFIG=(chicago,chicagoFS,chicagoFS1,boston)'  
  
LOG_ARCHIVE_DEST_2='SERVICE=chicagoFS SYNC AFFIRM  
VALID_FOR=(ONLINE_LOGFILES,PRIMARY_ROLE) DB_UNIQUE_NAME=chicagoFS  
GROUP=1 PRIORITY=1'  
  
LOG_ARCHIVE_DEST_STATE_2=ENABLE  
  
LOG_ARCHIVE_DEST_3='SERVICE=chicagoFS1 SYNC AFFIRM  
VALID_FOR=(ONLINE_LOGFILES,PRIMARY_ROLE) DB_UNIQUE_NAME=chicagoFS1  
GROUP=1 PRIORITY=1'  
  
LOG_ARCHIVE_DEST_STATE_3=ALTERNATE  
  
LOG_ARCHIVE_DEST_4='SERVICE=boston ASYNC NOAFFIRM  
VALID_FOR=(ONLINE_LOGFILES,PRIMARY_ROLE) DB_UNIQUE_NAME=boston GROUP=1  
PRIORITY=2'  
  
LOG_ARCHIVE_DEST_STATE_4=ALTERNATE
```

Oracle Data Guard can now continue synchronously sending redo to a far sync instance, maintaining the required zero data loss protection mode of Maximum Availability if a far sync instance fails. If both far sync instances fail, then redo ships in `ASYN` mode directly to `boston`, at a reduced protection level. As before, when either of the failed far sync instances becomes available again, Oracle Data Guard automatically resynchronizes it and returns to the original configuration, in which the primary sends redo to an active far sync instance, which then forwards that redo to the terminal standby. When the synchronization is complete, the alternate destination for the standby (`LOG_ARCHIVE_DEST_4` in the preceding example) again becomes dormant as the alternate.

### 5.3.3 Maintaining Protection After a Role Change

These examples describe how to maintain data protection after a role change.

The configuration described in the preceding sections works well to keep the configuration running at Maximum Availability until all far sync instances fail and redo is shipped to the standby database directly. But it would be inappropriate after a role transition where `boston` becomes the primary database and `chicago` becomes the terminal standby. The far sync instances `chicagoFS` and `chicagoFS1` would be too remote for `boston` to use as a synchronous destination because the network latency between two sites is sufficiently large that it would impact commit response times. To maintain the protection level of Maximum Availability for zero data loss, a second far sync instance configuration close to `boston` must be established, in readiness for a future role transition event.

Using the same procedure as described in [Creating and Configuring a Far Sync Instance](#), create two far sync instances named `bostonFS` and `bostonFS1` close to the standby database `boston` and configure them both to ship redo to `chicago` in `ASYNCR` mode when they are active. Then add them to `boston` so that when `boston` is the primary it ships redo to one of the far sync instances in `SYNC` mode with all the failover capabilities that were configured for `chicago` and its far sync instances. You need to add the new `boston` far sync instances to the `LOG_ARCHIVE_CONFIG` on both `boston` and `chicago`.

### Example 5-5 Parameters Used to Set Up Protection After a Role Change

#### Primary Database `boston`

```
LOG_ARCHIVE_CONFIG='DG_CONFIG=(chicago,chicagoFS,chicagoFS1,boston,
bostonFS, bostonFS1)'
```

```
LOG_ARCHIVE_DEST_2='SERVICE=bostonFS SYNC AFFIRM
VALID_FOR=(ONLINE_LOGFILES,PRIMARY_ROLE) DB_UNIQUE_NAME=bostonFS
GROUP=1 PRIORITY=1'
```

```
LOG_ARCHIVE_DEST_STATE_2=ENABLE
```

```
LOG_ARCHIVE_DEST_3='SERVICE=bostonFS1 SYNC AFFIRM
VALID_FOR=(ONLINE_LOGFILES,PRIMARY_ROLE) DB_UNIQUE_NAME=bostonFS1
GROUP=1 PRIORITY=1'
```

```
LOG_ARCHIVE_DEST_STATE_3=ALTERNATE
```

```
LOG_ARCHIVE_DEST_4='SERVICE=chicago ASYNC NOAFFIRM
VALID_FOR=(ONLINE_LOGFILES,PRIMARY_ROLE) DB_UNIQUE_NAME=chicago GROUP=1
PRIORITY=2'
```

```
LOG_ARCHIVE_DEST_STATE_4=ALTERNATE
```

#### Primary Database `chicago`

```
LOG_ARCHIVE_CONFIG='DG_CONFIG=(chicago,chicagoFS,chicagoFS1,boston,
bostonFS, bostonFS1)'
```

Given these declarations, the far sync instance, `bostonFS`, receives redo from `boston` and ships it to `chicago` only when `boston` is the primary database. However, even if `boston` is not the primary database, Oracle recommends keeping far sync instance `bostonFS` and `bostonFS1` mounted in readiness for a future role transition.

## 5.4 Supported Protection Modes for Far Sync Instances

A far sync instance is supported in either maximum performance or maximum availability mode.

## 5.4.1 Far Sync Instances in Maximum Availability Mode Configurations

In maximum availability mode, the far sync instance is relatively close to the primary database to minimize network latency, and the primary services the far sync instance using `SYNC` transport.

### Note:

There is no architectural limit to the distance that can separate the primary and far sync instance in maximum availability mode. The practical distance limit varies depending upon a given application's tolerance to the impact of network latency in a synchronous configuration. Also, it is possible to reduce the performance impact for any given distance by using the new Oracle Data Guard FastSync feature (`SYNC/NOAFFIRM`). See "[Performance Versus Protection in Maximum Availability Mode](#)".

Both `SYNC/AFFIRM` and `SYNC/NOAFFIRM` semantics are supported on the `LOG_ARCHIVE_DEST_n` established at the primary for the far sync instance. See [Oracle Data Guard Protection Modes](#) for information about the trade-offs of using each one.

When a primary services a far sync instance using `SYNC` transport, all committed redo resides on disk at the far sync instance. This allows the far sync instance to use one of the terminal standby destinations for a no data loss failover if the primary database is lost.

The far sync instance uses `ASync` transport to ship the incoming redo to terminal standbys that can be much farther away. This extends no data loss protection to destinations that are too far away for a primary database to feasibly service directly with `SYNC` transport because of the degradation in transaction throughput that would result. This is a case where a far sync instance is beneficial even if there is only one standby destination in the configuration.

## 5.4.2 Far Sync Instances in Maximum Performance Mode Configurations

In maximum performance mode, the primary database services the far sync instance destination using `ASync` redo transport.

This is true regardless of the physical distance between the primary and the far sync instance because high network latencies do not affect transaction throughput when a destination is serviced with `ASync` transport.

In maximum performance mode, a far sync instance can benefit Oracle Data Guard configurations that manage more than one remote destination. Although each `ASync` destination has a near-zero effect on primary database performance, if there are many remote destinations (for example, multiple Oracle Active Data Guard standbys that form a reader farm), then the effect can become measurable. When a far sync instance is used, there is zero incremental effect for each remote destination added to the configuration. Additionally, redo transport compression can also be offloaded to the far sync instance. When a far sync instance is used, the primary only has to service

the far sync instance, which then services the rest of the configuration; the greater the number of destinations, the greater the performance benefit.

# 6

## Oracle Data Guard Protection Modes

Oracle Data Guard lets you set different data protection modes.

See the following topics for information about these modes and how to set them on a primary database:

- [Oracle Data Guard Protection Modes](#)
- [Setting the Data Protection Mode of a Primary Database](#)

### 6.1 Oracle Data Guard Protection Modes

Oracle Data Guard provides three protection modes: maximum availability, maximum performance, and maximum protection.

In the following descriptions of the protection modes, a synchronized standby database is meant to be one that meets the minimum requirements of the configured data protection mode and that does not have a redo gap. Redo gaps are discussed in [Redo Gap Detection and Resolution](#).

#### Maximum Availability

This protection mode provides the highest level of data protection that is possible without compromising the availability of a primary database. Under normal operations, transactions do not commit until all redo data needed to recover those transactions has been written to the online redo log AND based on user configuration, one of the following is true:

- redo has been received at the standby, I/O to the standby redo log has been initiated, and acknowledgement sent back to primary
- redo has been received and written to standby redo log at the standby and acknowledgement sent back to primary

If the primary does not receive acknowledgement from at least one synchronized standby, then it operates as if it were in maximum performance mode to preserve primary database availability until it is again able to write its redo stream to a synchronized standby database.

If the primary database fails, then this mode ensures no data loss occurs provided there is at least one synchronized standby in the Oracle Data Guard configuration. See "[Performance Versus Protection in Maximum Availability Mode](#)" for information about the redo transport settings necessary to support Maximum Availability and associated trade-offs.

Transactions on the primary are considered protected as soon as Oracle Data Guard has written the redo data to persistent storage in a standby redo log file. Once that is done, acknowledgment is quickly made back to the primary database so that it can proceed to the next transaction. This minimizes the impact of synchronous transport on primary database throughput and response time. To fully benefit from complete Oracle Data Guard validation at the standby database, be sure to operate in real-time apply mode so that redo changes are applied to the standby database as fast as they



are received. Oracle Data Guard signals any corruptions that are detected so that immediate corrective action can be taken.

### Performance Versus Protection in Maximum Availability Mode

When you use Maximum Availability mode, it is important to understand the possible results of using the `LOG_ARCHIVE_DEST_n` attributes `SYNC/AFFIRM` versus `SYNC/NOAFFIRM` (FastSync) so that you can make the choice best suited to your needs.

When a transport is performed using `SYNC/AFFIRM`, the primary performs write operations and waits for acknowledgment that the redo has been transmitted synchronously to the physical standby and written to disk. A `SYNC/AFFIRM` transport provides an additional protection benefit at the expense of a performance impact caused by the time required to complete the I/O to the standby redo log.

When a transport is performed using `SYNC/NOAFFIRM`, the primary performs write operations and waits only for acknowledgement that the data has been received on the standby, *not* that it has been written to disk. The `SYNC/NOAFFIRM` transport can provide a performance benefit at the expense of potential exposure to data loss in a special case of multiple simultaneous failures.

With those definitions in mind, suppose you experience a catastrophic failure at the primary site at the same time that power is lost at the standby site. Whether data is lost depends on the transport mode being used. In the case of `SYNC/AFFIRM`, in which there is a check to confirm that data is written to disk on the standby, there would be no data loss because the data would be available on the standby when the system was recovered. In the case of `SYNC/NOAFFIRM`, in which there is no check that data has been written to disk on the standby, there may be some data loss.

#### See Also:

- [LOG\\_ARCHIVE\\_DEST\\_n Parameter Attributes](#) for more information about the `SYNC`, `AFFIRM`, and `NOAFFIRM` attributes
- *Oracle Data Guard Broker* for information about transporting redo in a broker configuration using `FASTSYNC` mode (using `SYNC` and `NOAFFIRM` together in maximum availability mode)

### Maximum Performance

This protection mode provides the highest level of data protection that is possible without affecting the performance of a primary database. This is accomplished by allowing transactions to commit as soon as all redo data generated by those transactions has been written to the online log. Redo data is also written to one or more standby databases, but this is done asynchronously with respect to transaction commitment, so primary database performance is unaffected by the time required to transmit redo data and receive acknowledgment from a standby database.

This protection mode offers slightly less data protection than maximum availability mode and has minimal impact on primary database performance.

This is the default protection mode.

### Maximum Protection

Maximum protection is similar to maximum availability but provides an additional level of data protection in the event of multiple failure events. Unlike maximum availability, which allows the primary to continue processing if it is unable to receive acknowledgement from a standby database, maximum protection shuts the primary database down rather than allowing it to continue processing transactions that are unprotected.

Because this data protection mode prioritizes data protection over primary database availability, Oracle recommends that a minimum of two standby databases be used to protect a primary database that runs in maximum protection mode to prevent a single standby database failure from causing the primary database to shut down.

 **Note:**

Asynchronously committed transactions are not protected by Oracle Data Guard against loss until the redo generated by those transactions has been written to the standby redo log of at least one synchronized standby database.

For more information about the asynchronous commit feature, see:

- *Oracle Database Concepts*
- *Oracle Database PL/SQL Language Reference*

## 6.2 Setting the Data Protection Mode of a Primary Database

Protection mode settings can be set and changed on an open database as long as the configuration meets the requirements of the protection mode (including going from maximum performance mode to maximum availability mode).

Perform the following steps to set the data protection mode of a primary database:

1. Select a data protection mode that meets your availability, performance, and data protection requirements. See [Oracle Data Guard Protection Modes](#) for a description of the data protection modes.
2. Verify that at least one standby database meets the redo transport requirements for the desired data protection mode.

The `LOG_ARCHIVE_DEST_n` database initialization parameter that corresponds to at least one standby database must include the redo transport attributes listed in the following table for the desired data protection mode.

The standby database must also have a standby redo log.

**Table 6-1 Required Redo Transport Attributes for Data Protection Modes**

Maximum Availability	Maximum Performance	Maximum Protection
AFFIRM or NOAFFIRM	NOAFFIRM	AFFIRM
SYNC	ASync	SYNC

**Table 6-1 (Cont.) Required Redo Transport Attributes for Data Protection Modes**

Maximum Availability	Maximum Performance	Maximum Protection
DB_UNIQUE_NAME	DB_UNIQUE_NAME	DB_UNIQUE_NAME

3. Verify that the `DB_UNIQUE_NAME` database initialization parameter has been set to a unique value on the primary database and on each standby database.
4. Verify that the `LOG_ARCHIVE_CONFIG` database initialization parameter has been defined on the primary database and on each standby database, and that its value includes a `DG_CONFIG` list that includes the `DB_UNIQUE_NAME` of the primary database and each standby database.

The following sample SQL statement configures the `LOG_ARCHIVE_CONFIG` parameter:

```
SQL> ALTER SYSTEM SET LOG_ARCHIVE_CONFIG='DG_CONFIG=(CHICAGO,BOSTON)';
```

5. Set the data protection mode by executing the following SQL statement on the primary database:

```
SQL> ALTER DATABASE -  
> SET STANDBY DATABASE TO MAXIMIZE {AVAILABILITY | PERFORMANCE | PROTECTION};
```

The data protection mode can be set to `MAXIMUM PROTECTION` on an open database only if the current data protection mode is `MAXIMUM AVAILABILITY` and if there is at least one synchronized standby database.

6. Perform the following query on the primary database to confirm that it is operating in the new protection mode:

```
SQL> SELECT PROTECTION_MODE FROM V$DATABASE;
```

# 7

## Redo Transport Services

An Oracle Data Guard configuration requires that Oracle redo transport services be configured and monitored.

See the following topics:

- [Introduction to Redo Transport Services](#)
- [Configuring Redo Transport Services](#)
- [Cascaded Redo Transport Destinations](#)
- [Data Protection Considerations for Cascading Standbys](#)
- [Validating a Configuration](#)
- [Monitoring Redo Transport Services](#)
- [Tuning Redo Transport](#)

### 7.1 Introduction to Redo Transport Services

**Redo transport services** performs the automated transfer of redo data between members of an Oracle Data Guard configuration and other databases.

The following redo transport destinations are supported:

- Oracle Data Guard standby databases  
This guide describes how to create and manage physical, logical, and snapshot standby databases.
- Archive log repository  
This destination type is used for temporary offsite storage of archived redo log files. An archive log repository consists of an Oracle database instance and a physical standby control file. An archive log repository does not contain data files, so it cannot support role transitions.  
The procedure used to create an archive log repository is identical to the procedure used to create a physical standby database, except for the copying of data files.
- Oracle Streams downstream capture databases
- Far sync instances  
See [Using Far Sync Instances](#) for more information about far sync instances.
- Zero Data Loss Recovery Appliance (Recovery Appliance)

Each redo transport destination is individually configured to receive redo data via one of two redo transport modes:

- Synchronous

The synchronous redo transport mode transmits redo data synchronously with respect to transaction commit. A transaction cannot commit until all redo generated by that transaction has been successfully sent to every enabled redo transport destination that uses the synchronous redo transport mode.

Although there is no limit on the distance between a primary database and a `SYNC` redo transport destination, transaction commit latency increases as network latency increases between a primary database and a `SYNC` redo transport destination.

This transport mode is used by the Maximum Protection and Maximum Availability data protection modes described in [Oracle Data Guard Protection Modes](#).

 **Note:**

Synchronous redo transport is not supported for Zero Data Loss Recovery Appliance.

- Asynchronous

The asynchronous redo transport mode transmits redo data asynchronously with respect to transaction commit. A transaction can commit without waiting for the redo generated by that transaction to be successfully sent to any redo transport destination that uses the asynchronous redo transport mode.

This transport mode is used by the Maximum Performance data protection mode described in [Oracle Data Guard Protection Modes](#).

## 7.2 Configuring Redo Transport Services

Oracle databases must be configured before they can send and receive redo data. Part of the configuration process involves setting up redo transport security.

See the following topics:

- [Redo Transport Security](#)
- [Configuring an Oracle Database to Send Redo Data](#)
- [Configuring an Oracle Database to Receive Redo Data](#)

These topics assume that you have a thorough understanding of the following:

- Database administrator authentication
- Database initialization parameters
- Managing a redo log
- Managing archived redo logs
- Fast recovery areas
- Oracle Net Configuration

### 7.2.1 Redo Transport Security

Redo transport uses Oracle Net sessions to transport redo data.

These redo transport sessions are authenticated using either the Secure Socket Layer (SSL) protocol or a remote login password file.

### 7.2.1.1 Redo Transport Authentication Using SSL

Secure Sockets Layer (SSL) is an industry standard protocol for securing network connections.

SSL uses RSA public key cryptography and symmetric key cryptography to provide authentication, encryption, and data integrity. SSL is automatically used for redo transport authentication between two Oracle databases if:

- The databases are members of the same Oracle Internet Directory (OID) enterprise domain and that domain allows the use of current user database links.
- The `LOG_ARCHIVE_DEST_n`, and `FAL_SERVER` database initialization parameters that correspond to the databases use Oracle Net connect descriptors configured for SSL.
- Each database has an Oracle wallet or a supported hardware security module that contains a user certificate with a distinguished name (DN) that matches the DN in the OID entry for the database.

#### See Also:

- *Oracle Database Security Guide* for more information about SSL
- *Oracle Database Enterprise User Security Administrator's Guide* for more information about administering enterprise domains
- *Oracle Label Security Administrator's Guide* for information about administering Oracle Internet Directory

### 7.2.1.2 Redo Transport Authentication Using a Password File

If the SSL authentication requirements are not met, then each database must use a remote login password file.

In an Oracle Data Guard configuration, all physical and snapshot standby databases must use a copy of the password file from the primary database. If database compatibility is set to 12.2 or higher on both the source and target database, then the copy of the password file is automatically refreshed whenever an administrative privilege (`SYSDG`, `SYSOPER`, `SYSDBA`, and so on) is granted or revoked, and after the password of any user with administrative privileges is changed. The only exception to this is far sync instances. Updated password files must still be manually copied to far sync instances because far sync instances receive redo, but do not apply it. Once the password file is up-to-date at the far sync instance the redo containing the password update at the primary is automatically propagated to any standby databases that are set up to receive redo from that far sync instance. The password file is updated on the standby when the redo is applied.

When a password file is used for redo transport authentication, the password of the user account used for redo transport authentication is compared between the database initiating a redo transport session and the target database. The password must be the same at both databases to create a redo transport session.

By default, the password of the SYS user is used to authenticate redo transport sessions when a password file is used. The REDO\_TRANSPORT\_USER database initialization parameter can be used to select a different user password for redo transport authentication by setting this parameter to the name of any user who has been granted the SYSOPER privilege. For administrative ease, Oracle recommends that the REDO\_TRANSPORT\_USER parameter be set to the same value on the redo source database and at each redo transport destination.

 **See Also:**

*Oracle Database Administrator's Guide* for more information creating and maintaining remote login password files

## 7.2.2 Configuring an Oracle Database to Send Redo Data

To specify a redo transport destination, use the LOG\_ARCHIVE\_DEST\_ *n* database initialization parameter (where *n* is an integer from 1 to 31).

There is a LOG\_ARCHIVE\_DEST\_STATE\_ *n* database initialization parameter (where *n* is an integer from 1 to 31) that corresponds to each LOG\_ARCHIVE\_DEST\_ *n* parameter. This parameter is used to enable or disable the corresponding redo destination. [Table 7-1](#) shows the valid values that can be assigned to this parameter.

**Table 7-1 LOG\_ARCHIVE\_DEST\_STATE\_ *n* Initialization Parameter Values**

Value	Description
ENABLE	Redo transport services can transmit redo data to this destination. This is the default.
DEFER	Redo transport services do not transmit redo data to this destination.
ALTERNATE	This destination becomes enabled if communication to its associated destination fails.

A redo transport destination is configured by setting the LOG\_ARCHIVE\_DEST\_ *n* parameter to a character string that includes one or more attributes. This section briefly describes the most commonly used attributes. See [LOG\\_ARCHIVE\\_DEST\\_ \*n\* Parameter Attributes](#) for a full description of all LOG\_ARCHIVE\_DEST\_ *n* parameter attributes.

The SERVICE attribute, which is a mandatory attribute for a redo transport destination, must be the first attribute specified in the attribute list. The SERVICE attribute is used to specify the Oracle Net service name used to connect to the redo transport destination. The service name must be resolvable through an Oracle Net naming method to an Oracle Net connect descriptor that matches the Oracle Net listener(s) at the redo transport destination. The connect descriptor must specify that a dedicated server connection be used, unless that is the default connection type for the redo transport destination.

 **See Also:**

*Oracle Database Net Services Administrator's Guide* for information about Oracle Net service names, connect descriptors, listeners, and network security

The `SYNC` attribute specifies that the synchronous redo transport mode be used to send redo data to a redo transport destination.

The `ASYNC` attribute specifies that the asynchronous redo transport mode be used to send redo data to a redo transport destination. The asynchronous redo transport mode is used if neither the `SYNC` nor the `ASYNC` attribute is specified.

The `NET_TIMEOUT` attribute specifies how long the `LGWR` process waits for an acknowledgement that redo data has been successfully received by a destination that uses the synchronous redo transport mode. If an acknowledgement is not received within `NET_TIMEOUT` seconds, the redo transport connection is terminated and an error is logged.

Oracle recommends that the `NET_TIMEOUT` attribute be specified whenever the synchronous redo transport mode is used, so that the maximum duration of a redo source database stall caused by a redo transport fault can be precisely controlled. See [Monitoring Synchronous Redo Transport Response Time](#) for information about monitoring synchronous redo transport mode response time.

 **Note:**

You could also set the database initialization parameter, `DATA_GUARD_SYNC_LATENCY`, which is global for all synchronous standby destinations. It defines the maximum amount of time (in seconds) that the primary database may wait before disconnecting subsequent destinations after at least one synchronous standby has acknowledged receipt of the redo.

For example, suppose you have three synchronous standby destinations and you set `DATA_GUARD_SYNC_LATENCY` to a value of 2. If the first standby acknowledges receipt of the redo immediately, then the primary database waits no longer than 2 seconds for the other two standbys to respond. If one or both respond within 2 seconds, then they are maintained as active destinations. Destinations that do not respond in time are marked as failed. In both cases the primary remains in zero data loss protection mode because one synchronous standby has acknowledged receipt of the redo. Any failed synchronous standbys are reconnected as normal after the number of seconds specified for the `REOPEN` attribute have passed.

The `AFFIRM` attribute is used to specify that redo received from a redo source database is not acknowledged until it has been written to the standby redo log. The `NOAFFIRM` attribute is used to specify that received redo is acknowledged without waiting for received redo to be written to the standby redo log.

The `DB_UNIQUE_NAME` attribute is used to specify the `DB_UNIQUE_NAME` of a redo transport destination. The `DB_UNIQUE_NAME` attribute must be specified if the



LOG\_ARCHIVE\_CONFIG database initialization parameter has been defined and its value includes a DG\_CONFIG list.

If the DB\_UNIQUE\_NAME attribute is specified, its value must match one of the DB\_UNIQUE\_NAME values in the DG\_CONFIG list. It must also match the value of the DB\_UNIQUE\_NAME database initialization parameter at the redo transport destination. If either match fails, an error is logged and redo transport is not possible to that destination.

The VALID\_FOR attribute is used to specify when redo transport services transmits redo data to a redo transport destination. Oracle recommends that the VALID\_FOR attribute be specified for each redo transport destination at every site in an Oracle Data Guard configuration so that redo transport services continue to send redo data to all standby databases after a role transition, regardless of which standby database assumes the primary role.

The REOPEN attribute is used to specify the minimum number of seconds between automatic reconnect attempts to a redo transport destination that is inactive because of a previous error.

The COMPRESSION attribute is used to specify that redo data is transmitted to a redo transport destination in compressed form. Redo transport compression can significantly improve redo transport performance on network links with low bandwidth and high latency.

Redo transport compression is a feature of the Oracle Advanced Compression option. You must purchase a license for this option before using the redo transport compression feature.

The following example uses all of the LOG\_ARCHIVE\_DEST\_n attributes described in this section. A DB\_UNIQUE\_NAME has been specified for both destinations, as has the use of compression. If a redo transport fault occurs at either destination, then redo transport attempts to reconnect to that destination, but not more frequently than once every 60 seconds.

```
DB_UNIQUE_NAME=BOSTON
LOG_ARCHIVE_CONFIG='DG_CONFIG=(BOSTON,CHICAGO,HARTFORD) '
LOG_ARCHIVE_DEST_2='SERVICE=CHICAGO ASYNC NOAFFIRM VALID_FOR=(ONLINE_LOGFILE,
PRIMARY_ROLE) REOPEN=60 COMPRESSION=ENABLE DB_UNIQUE_NAME=CHICAGO'
LOG_ARCHIVE_DEST_STATE_2='ENABLE'
LOG_ARCHIVE_DEST_3='SERVICE=HARTFORD SYNC AFFIRM NET_TIMEOUT=30
VALID_FOR=(ONLINE_LOGFILE,PRIMARY_ROLE) REOPEN=60 COMPRESSION=ENABLE
DB_UNIQUE_NAME=HARTFORD'
LOG_ARCHIVE_DEST_STATE_3='ENABLE'
```

 **Note:**

Configuration for Zero Data Loss Recovery Appliance (Recovery Appliance) is identical to configuration for any standby database. So in the preceding example, because Chicago is an ASYNC destination, it could be either a standby database or a Recovery Appliance. (Synchronous redo transport is not supported for Recovery Appliance)

### 7.2.2.1 Viewing Attributes With V\$ARCHIVE\_DEST

The V\$ARCHIVE\_DEST view can be queried to see the current settings and status for each redo transport destination.

## 7.2.3 Configuring an Oracle Database to Receive Redo Data

Redo transport destination must be configured to receive and to archive redo data from a redo source database.

See the following:

- [Managing Standby Redo Logs](#)
- [Cases Where Redo Is Written Directly To an Archived Redo Log File](#)

### 7.2.3.1 Managing Standby Redo Logs

The synchronous and asynchronous redo transport modes require that a redo transport destination have a standby redo log. A standby redo log is used to store redo received from another Oracle database. Standby redo logs are structurally identical to redo logs, and are created and managed using the same SQL statements used to create and manage redo logs.

Redo received from another Oracle database via redo transport is written to the current standby redo log group by a remote file server (RFS) foreground process. When a log switch occurs on the redo source database, incoming redo is then written to the next standby redo log group, and the previously used standby redo log group is archived by an ARC<sub>n</sub> background process.

The process of sequentially filling and then archiving redo log file groups at a redo source database is mirrored at each redo transport destination by the sequential filling and archiving of standby redo log groups.

Each standby redo log file must be at least as large as the largest redo log file in the redo log of the redo source database. For administrative ease, Oracle recommends that all redo log files in the redo log at the redo source database and the standby redo log at a redo transport destination be of the same size.

The standby redo log must have at least one more redo log group than the redo log at the redo source database, for each redo thread at the redo source database. At the redo source database, query the V\$LOG view to determine how many redo log groups are in the redo log at the redo source database and query the V\$THREAD view to determine how many redo threads exist at the redo source database.

Perform the following query on a redo source database to determine the size of each log file and the number of log groups in the redo log:

```
SQL> SELECT GROUP#, BYTES FROM V$LOG;
```

Perform the following query on a redo destination database to determine the size of each log file and the number of log groups in the standby redo log:

```
SQL> SELECT GROUP#, BYTES FROM V$STANDBY_LOG;
```

If the redo source database is an Oracle Real Applications Cluster (Oracle RAC) or Oracle Real Application Clusters One Node (Oracle RAC One Node) database, query the `V$LOG` view at the redo source database to determine how many redo threads exist and specify the corresponding thread numbers when adding redo log groups to the standby redo log.

The following sample SQL statements create a standby redo log at a database that is to receive redo from a redo source database that has two redo threads:

```
SQL> ALTER DATABASE ADD STANDBY LOGFILE THREAD 1 SIZE 500M;  
SQL> ALTER DATABASE ADD STANDBY LOGFILE THREAD 1 SIZE 500M;  
SQL> ALTER DATABASE ADD STANDBY LOGFILE THREAD 1 SIZE 500M;  
SQL> ALTER DATABASE ADD STANDBY LOGFILE THREAD 2 SIZE 500M;  
SQL> ALTER DATABASE ADD STANDBY LOGFILE THREAD 2 SIZE 500M;  
SQL> ALTER DATABASE ADD STANDBY LOGFILE THREAD 2 SIZE 500M;
```

 **Note:**

Whenever a redo log group is added to a primary database, a log group must also be added to the standby redo log of each standby database in the configuration. Otherwise, the standby database may become unsynchronized after a primary log switch, which could temporarily prevent a zero data loss failover or cause a primary database operating in maximum protection mode to shut down.

### 7.2.3.2 Cases Where Redo Is Written Directly To an Archived Redo Log File

Redo received by a standby database is written directly to an archived redo log file if a standby redo log group is not available or if the redo was sent to resolve a redo gap. When this occurs, redo is written to the location specified by the `LOCATION` attribute of one `LOG_ARCHIVE_DEST_n` parameter that is valid for archiving redo received from another database. The `LOG_ARCHIVE_DEST_n` parameter that is used for this purpose is determined when the standby database is mounted, and this choice is reevaluated each time a `LOG_ARCHIVE_DEST_n` parameter is modified.

## 7.3 Cascaded Redo Transport Destinations

A cascaded redo transport destination (also known as a terminal destination) receives primary database redo indirectly from a standby database rather than directly from a primary database.

A physical standby database that cascades primary database redo to one or more terminal destinations at the same time it is applying changes to its local database files is known as a cascading standby database.

With cascading, the overhead associated with performing redo transport is offloaded from a primary database to a cascading standby database.

A cascading standby database can cascade primary database redo to up to 30 terminal destinations.

A cascading standby database can either cascade redo in real-time (as it is being written to the standby redo log file) or non-real-time (as complete standby redo log files are being archived on the cascading standby).

Cascading has the following restrictions:

- Only physical standby databases can cascade redo.
- Real-time cascading requires a license for the Oracle Active Data Guard option.
- Non-real-time cascading is supported on destinations 1 through 10 only. (Real-time cascading is supported on all destinations.)

 **Note:**

See [Before You Patch or Upgrade the Oracle Database Software](#) for information about how to handle cascaded redo transport destinations during an Oracle Database upgrade.

Also see the following topics:

- [Configuring a Terminal Destination](#)
- [Cascading Scenarios](#)

## 7.3.1 Configuring a Terminal Destination

These steps describe how to configure a terminal destination.

1. Select a physical standby database to configure as a cascading standby database.
2. On the cascading standby database, configure the `FAL_SERVER` database initialization parameter with the Oracle Net alias of the primary database or of a standby database that receives redo directly from the primary database.
3. On the cascading standby database, configure a `LOG_ARCHIVE_DEST_n` database initialization parameter for one or more terminal destinations. Configure the `SERVICE` attribute of this destination with the Oracle Net alias of the terminal destination, and the `VALID` attribute to be valid for archival of the standby redo log while in the standby role.

If you specify `ASYNC` transport mode on destinations 1 through 10, then redo is shipped in real-time. If you do not specify a transport mode or you specify `SYNC` on destinations 1 through 10, then redo is shipped in non-real-time. Destinations 11 through 31 operate only in `ASYNC` (real-time) transport mode.

4. At the terminal destination, configure the `FAL_SERVER` database initialization parameter with the Oracle Net alias of the cascading standby database or of another standby database that is directly connected to the primary database. Although it is also possible to specify the primary database, this would defeat the purpose of cascading, which is to reduce the redo transport overhead on the primary database.
5. [Example 7-1](#) shows some of the database initialization parameters used by the members of an Oracle Data Guard configuration that includes a primary database named `boston` that sends redo to a local physical standby database named `boston2`, which then cascades primary database redo to a remote physical standby database named `denver`.

A `LOG_ARCHIVE_DEST_n` database initialization parameter could also be configured on database `boston` that is valid for standby redo log archival to database `denver`

when database `boston` is in the standby role. This would allow redo cascading to database `denver` to continue if a switchover is performed between database `boston` and database `boston2`.

### Example 7-1 Some of the Initialization Parameters Used When Cascading Redo

#### Primary Database

```
DB_UNIQUE_NAME=boston

FAL_SERVER=boston2

LOG_ARCHIVE_CONFIG='DG_CONFIG=(boston,boston2,denver) '

LOG_ARCHIVE_DEST_1='LOCATION=USE_DB_RECOVERY_FILE_DEST
VALID_FOR=(ALL_LOGFILES,ALL_ROLES) DB_UNIQUE_NAME=boston'

LOG_ARCHIVE_DEST_2='SERVICE=boston2 SYNC
VALID_FOR=(ONLINE_LOGFILES,PRIMARY_ROLE) DB_UNIQUE_NAME=boston2'
```

#### Cascading Physical Standby Database

```
DB_UNIQUE_NAME=boston2

FAL_SERVER=boston

LOG_ARCHIVE_CONFIG=' DG_CONFIG=(boston,boston2,denver) '

LOG_ARCHIVE_DEST_1='LOCATION= USE_DB_RECOVERY_FILE_DEST
VALID_FOR=(ALL_LOGFILES,ALL_ROLES) DB_UNIQUE_NAME=boston2'

LOG_ARCHIVE_DEST_2=' SERVICE=denver
VALID_FOR=(STANDBY_LOGFILES,STANDBY_ROLE) DB_UNIQUE_NAME=denver'
```

#### Cascaded Physical Standby Database

```
DB_UNIQUE_NAME=denver

FAL_SERVER=boston2

LOG_ARCHIVE_CONFIG='DG_CONFIG=(boston,boston2,denver) '

LOG_ARCHIVE_DEST_1='LOCATION= USE_DB_RECOVERY_FILE_DEST
VALID_FOR=(ALL_LOGFILES,ALL_ROLES) DB_UNIQUE_NAME=denver'
```

For information about validating a configuration after you set up a cascading environment, see "[Validating a Configuration](#)".

## 7.3.2 Cascading Scenarios

A Data Guard configuration can be set up to cascade to a single physical standby or to multiple physical standbys.

See the following topics:

- [Cascading to a Physical Standby](#)
- [Cascading to Multiple Physical Standbys](#)

### 7.3.2.1 Cascading to a Physical Standby

These steps provide an example of cascading to a physical standby database.

In this scenario, you have a mission-critical primary database. This database has stringent performance and data protection requirements, so you have decided to deploy a local physical standby database to provide zero data loss protection and a remote, cascaded physical standby database to protect against regional disasters at the primary and local standby database sites.

You can achieve the objectives described above by performing the following steps:

1. Create a physical standby database at a local site.
2. Create a physical standby database at a site that is sufficiently remote to provide protection against regional disasters at the primary and local standby database sites.
3. Configure the local standby database as a `SYNC` redo transport destination of the primary database.
4. Configure the remote physical standby database as a terminal destination of the local standby database.

### 7.3.2.2 Cascading to Multiple Physical Standbys

These steps provide an example of cascading to multiple physical standby databases.

In this scenario, you have a primary database in North America and you want to deploy three replicas of this database in Europe to support read-only reporting applications. For cost and performance reasons, you do not want to maintain network links from North America to each of your European sites.

You can achieve the objectives described above by performing the following steps:

1. Create a network link between your North American site and one of your European sites.
2. Create a physical standby database at each of your European sites.
3. Open your physical standby databases in real-time query mode, as described in [Opening a Physical Standby Database](#).
4. Configure the physical standby database at the European endpoint of your transatlantic network link to cascade redo to your other European standby databases.
5. Configure the other two physical standby databases as terminal destinations of the cascading standby database configured in step 4.

## 7.4 Data Protection Considerations for Cascading Standbys

When your configuration includes cascading standbys, each destination should have a `LOG_ARCHIVE_DEST_n` parameter defined that points back to its source for use during a failover.

Real-time cascade enables a cascaded standby database to provide nearly the same level of data protection as any standby database that receives redo directly from a primary database using asynchronous redo transport. However, although redo is

forwarded in real-time, the fact that there is a second network hop creates the potential for additional data loss if an outage prevents all redo from reaching the terminal destination.

## 7.5 Validating a Configuration

To validate an Oracle Data Guard configuration after you create it, query the `V$DATAGUARD_CONFIG` view from any database in the configuration.

The view displays the unique database names defined with the `DB_UNIQUE_NAME` and `LOG_ARCHIVE_CONFIG` initialization parameters.

### See Also:

- *Oracle Database Reference* for more information about the `V$DATAGUARD_CONFIG` view

## 7.6 Monitoring Redo Transport Services

You can monitor redo transport status, as well as redo transport response time.

See the following topics:

- [Monitoring Redo Transport Status](#)
- [Monitoring Synchronous Redo Transport Response Time](#)
- [Redo Gap Detection and Resolution](#)
- [Redo Transport Services Wait Events](#)

### 7.6.1 Monitoring Redo Transport Status

You can query views to monitor redo transport status on a redo source database.

Take the following steps to monitor redo transport status on a redo source database.

1. Perform the following query on the redo source database to determine the most recently archived sequence number for each thread:

```
SQL> SELECT MAX(SEQUENCE#), THREAD# FROM V$ARCHIVED_LOG -
> WHERE RESETLOGS_CHANGE# = (SELECT MAX(RESETLOGS_CHANGE#) FROM
V$ARCHIVED_LOG) -
> GROUP BY THREAD#;
```

2. Perform the following query on the redo source database to determine the most recently archived redo log file at each redo transport destination:

```
SQL> SELECT DESTINATION, STATUS, ARCHIVED_THREAD#, ARCHIVED_SEQ# -
> FROM V$ARCHIVE_DEST_STATUS -
> WHERE STATUS <> 'DEFERRED' AND STATUS <> 'INACTIVE';
```

DESTINATION	STATUS	ARCHIVED_THREAD#	ARCHIVED_SEQ#
/private1/prmy/lad	VALID	1	947
standby1	VALID	1	947

The most recently archived redo log file should be the same for each destination. If it is not, a status other than `VALID` may identify an error encountered during the archival operation to that destination.

3. Perform a query at a redo source database to find out if an archived redo log file has been received at a particular redo transport destination. Each destination has an ID number associated with it. You can query the `DEST_ID` column of the `V$ARCHIVE_DEST` view on a database to identify each destination's ID number.

Assume that destination 1 points to the local archived redo log and that destination 2 points to a redo transport destination. Perform the following query at the redo source database to find out if any log files are missing at the redo transport destination:

```
SQL> SELECT LOCAL.THREAD#, LOCAL.SEQUENCE# FROM -
> (SELECT THREAD#, SEQUENCE# FROM V$ARCHIVED_LOG WHERE DEST_ID=1) -
> LOCAL WHERE -
> LOCAL.SEQUENCE# NOT IN -
> (SELECT SEQUENCE# FROM V$ARCHIVED_LOG WHERE DEST_ID=2 AND -
> THREAD# = LOCAL.THREAD#);
```

THREAD#	SEQUENCE#
1	12
1	13
1	14

4. Set the `LOG_ARCHIVE_TRACE` database initialization parameter at a redo source database and at each redo transport destination to trace redo transport progress. See [Setting Archive Tracing](#) for complete details and examples.

## 7.6.2 Monitoring Synchronous Redo Transport Response Time

The `V$REDO_DEST_RESP_HISTOGRAM` view contains response time data for each redo transport destination.

The response time data is maintained for redo transport messages sent via the synchronous redo transport mode.

The data for each destination consists of a series of rows, with one row for each response time. To simplify record keeping, response times are rounded up to the nearest whole second for response times less than 300 seconds. Response times greater than 300 seconds are round up to 600, 1200, 2400, 4800, or 9600 seconds.

Each row contains four columns: `FREQUENCY`, `DURATION`, `DEST_ID`, and `TIME`.

The `FREQUENCY` column contains the number of times that a given response time has been observed. The `DURATION` column corresponds to the response time. The `DEST_ID` column identifies the destination. The `TIME` column contains a timestamp taken when the row was last updated.

The response time data in this view is useful for identifying synchronous redo transport mode performance issues that can affect transaction throughput on a redo source database. It is also useful for tuning the `NET_TIMEOUT` attribute.

The next three examples show example queries for destination 2, which corresponds to the `LOG_ARCHIVE_DEST_2` parameter. To display response time data for a different destination, simply change the `DEST_ID` in the query.



Perform the following query on a redo source database to display the response time histogram for destination 2:

```
SQL> SELECT FREQUENCY, DURATION FROM -  
> V$REDO_DEST_RESP_HISTOGRAM WHERE DEST_ID=2 AND FREQUENCY>1;
```

Perform the following query on a redo source database to display the slowest response time for destination 2:

```
SQL> SELECT max(DURATION) FROM V$REDO_DEST_RESP_HISTOGRAM -  
> WHERE DEST_ID=2 AND FREQUENCY>1;
```

Perform the following query on a redo source database to display the fastest response time for destination 2:

```
SQL> SELECT min( DURATION) FROM V$REDO_DEST_RESP_HISTOGRAM -  
> WHERE DEST_ID=2 AND FREQUENCY>1;
```

 **Note:**

The highest observed response time for a destination cannot exceed the highest specified `NET_TIMEOUT` value specified for that destination, because synchronous redo transport mode sessions are terminated if a redo transport destination does not respond to a redo transport message within `NET_TIMEOUT` seconds.

## 7.6.3 Redo Gap Detection and Resolution

A redo gap occurs whenever redo transmission is interrupted.

When redo transmission resumes, redo transport services automatically detects the redo gap and resolves it by sending the missing redo to the destination.

The time needed to resolve a redo gap is directly proportional to the size of the gap and inversely proportional to the effective throughput of the network link between the redo source database and the redo transport destination. Use redo transport compression to reduce the redo gap resolution time. The `COMPRESSION` attribute of the `LOG_ARCHIVE_DEST_n` parameter is used to specify that redo data be compressed before transmission to the destination.

See [LOG\\_ARCHIVE\\_DEST\\_n Parameter Attributes](#) for more information about the `COMPRESSION` attribute.

### 7.6.3.1 Manual Gap Resolution

In some situations, gap resolution cannot be performed automatically and it must be performed manually.

For example, redo gap resolution must be performed manually on a logical standby database if the primary database is unavailable.

Perform the following query at the physical standby database to determine if there is redo gap on a physical standby database:

```
SQL> SELECT * FROM V$ARCHIVE_GAP;

  THREAD#  LOW_SEQUENCE#  HIGH_SEQUENCE#
-----  -
1          1              7              10
```

The output from the previous example indicates that the physical standby database is currently missing log files from sequence 7 to sequence 10 for thread 1.

Perform the following query on the primary database to locate the archived redo log files on the primary database (assuming the local archive destination on the primary database is LOG\_ARCHIVE\_DEST\_1):

```
SQL> SELECT NAME FROM V$ARCHIVED_LOG WHERE THREAD#=1 AND -
> DEST_ID=1 AND SEQUENCE# BETWEEN 7 AND 10;

NAME
-----
/primary/thread1_dest/arcr_1_7.arc
/primary/thread1_dest/arcr_1_8.arc
/primary/thread1_dest/arcr_1_9.arc
```

 **Note:**

This query may return consecutive sequences for a given thread. In that case, there is no actual gap, but the associated thread was disabled and enabled within the time period of generating these two archived logs. The query also does not identify the gap that may exist at the tail end for a given thread. For instance, if the primary database has generated archived logs up to sequence 100 for thread 1, and the latest archived log that the logical standby database has received for the given thread is the one associated with sequence 77, then this query does not return any rows, although there is a gap for the archived logs associated with sequences 78 to 100.

Copy these log files to the physical standby database and register them using the ALTER DATABASE REGISTER LOGFILE. For example:

```
SQL> ALTER DATABASE REGISTER LOGFILE -
> '/physical_standby1/thread1_dest/arcr_1_7.arc';

SQL> ALTER DATABASE REGISTER LOGFILE -
> '/physical_standby1/thread1_dest/arcr_1_8.arc';

SQL> ALTER DATABASE REGISTER LOGFILE -
> '/physical_standby1/thread1_dest/arcr_1_9.arc';
```

 **Note:**

The `V$ARCHIVE_GAP` view on a physical standby database only returns the gap that is currently blocking Redo Apply from continuing. After resolving the gap, query the `V$ARCHIVE_GAP` view again on the physical standby database to determine if there is another gap sequence. Repeat this process until there are no more gaps.

To determine if there is a redo gap on a logical standby database, query the `DBA_LOGSTDBY_LOG` view on the logical standby database. For example, the following query indicates there is a gap in the sequence of archived redo log files because it displays two files for `THREAD 1` on the logical standby database. (If there are no gaps, then the query shows only one file for each thread.) The output shows that the highest registered file is sequence number 10, but there is a gap at the file shown as sequence number 6:

```
SQL> COLUMN FILE_NAME FORMAT a55
SQL> SELECT THREAD#, SEQUENCE#, FILE_NAME FROM DBA_LOGSTDBY_LOG L -
> WHERE NEXT_CHANGE# NOT IN -
> (SELECT FIRST_CHANGE# FROM DBA_LOGSTDBY_LOG WHERE L.THREAD# = THREAD#) -
> ORDER BY THREAD#, SEQUENCE#;
```

THREAD#	SEQUENCE#	FILE_NAME
1	6	/disk1/oracle/dbs/log-1292880008_6.arc
1	10	/disk1/oracle/dbs/log-1292880008_10.arc

Copy the missing log files, with sequence numbers 7, 8, and 9, to the logical standby system and register them using the `ALTER DATABASE REGISTER LOGICAL LOGFILE` statement. For example:

```
SQL> ALTER DATABASE REGISTER LOGICAL LOGFILE -
> '/disk1/oracle/dbs/log-1292880008_7.arc';

SQL> ALTER DATABASE REGISTER LOGICAL LOGFILE -
> '/disk1/oracle/dbs/log-1292880008_8.arc';

SQL> ALTER DATABASE REGISTER LOGICAL LOGFILE -
> '/disk1/oracle/dbs/log-1292880008_9.arc';
```

 **Note:**

A query based on the `DBA_LOGSTDBY_LOG` view on a logical standby database, as specified above, only returns the gap that is currently blocking SQL Apply from continuing. After resolving the gap, query the `DBA_LOGSTDBY_LOG` view again on the logical standby database to determine if there is another gap sequence. Repeat this process until there are no more gaps.

## 7.6.4 Redo Transport Services Wait Events

You can use Oracle wait events to track redo transport wait time on a redo source database.

[Table 7-2](#) lists several of these Oracle wait events, which are found in the `V$SYSTEM_EVENT` dynamic performance view.

For a complete list of the Oracle wait events used by redo transport, see the Oracle Data Guard Redo Transport and Network Best Practices technical brief on the Oracle Maximum Availability Architecture (MAA) home page at:

<http://www.oracle.com/goto/maa>

**Table 7-2 Redo Transport Wait Events**

Wait Event	Description
LNS wait on ATTACH	Total time spent waiting for redo transport sessions to be established to all <code>ASYN</code> and <code>SYN</code> redo transport destinations
LNS wait on SENDREQ	Total time spent waiting for redo data to be written to all <code>ASYN</code> and <code>SYN</code> redo transport destinations
LNS wait on DETACH	Total time spent waiting for redo transport connections to be terminated to all <code>ASYN</code> and <code>SYN</code> redo transport destinations

## 7.7 Tuning Redo Transport

You can optimize redo transport for best performance.

Data Guard automatically tunes redo transport to optimize performance. However, if you want more control over the tuning, you can tune the following areas that are used in redo transport:

- network configuration
- storage configuration
- fast recovery area
- redo transport configuration

See the Oracle Data Guard Redo Transport and Network Configuration Best Practices technical brief available on the Oracle Maximum Availability Architecture (MAA) home page at:

<http://www.oracle.com/goto/maa>

# 8

## Apply Services

These concepts describe how redo data is applied to a standby database.

- [Introduction to Apply Services](#)
- [Apply Services Configuration Options](#)
- [Applying Redo Data to Physical Standby Databases](#)
- [Applying Redo Data to Logical Standby Databases](#)
- [Standby Considerations When Removing or Renaming a PDB at a Primary](#)

### 8.1 Introduction to Apply Services

**Apply services** automatically apply *redo* to standby databases to maintain synchronization with the primary database and allow transactionally consistent access to the data.

By default, apply services waits for a standby redo log file to be archived before applying the redo that it contains. However, you can enable real-time apply, which allows apply services to apply the redo in the current standby redo log file as it is being filled. Real-time apply is described in more detail in [Using Real-Time Apply to Apply Redo Data Immediately](#).

Apply services use the following methods to maintain physical and logical standby databases:

- **Redo Apply** (physical standby databases only)  
Uses media recovery to keep the primary and physical standby databases synchronized.
- **SQL Apply** (logical standby databases only)  
Reconstitutes SQL statements from the redo received from the primary database and executes the SQL statements against the logical standby database.

### 8.2 Apply Services Configuration Options

You can apply redo data immediately or you can specify a time delay to apply archived redo log files.

See the following topics:

- [Using Real-Time Apply to Apply Redo Data Immediately](#)
- [Specifying a Time Delay for the Application of Archived Redo Log Files](#)

## 8.2.1 Using Real-Time Apply to Apply Redo Data Immediately

If the real-time apply feature is enabled, then apply services can apply redo data as it is received, without waiting for the current standby redo log file to be archived.

This results in faster switchover and failover times because the standby redo log files have already been applied to the standby database by the time the failover or switchover begins. It also enables real-time reporting on an Oracle Active Data Guard standby by keeping it more closely synchronized with the primary database.

Use the `ALTER DATABASE` statement to enable the real-time apply feature, as follows:

- For physical standby databases, issue the `ALTER DATABASE RECOVER MANAGED STANDBY DATABASE` statement. (As of Oracle Database 12c Release 1 (12.1), the `USING CURRENT LOGFILE` clause is deprecated and no longer necessary to start real-time apply.)
- For logical standby databases, issue the `ALTER DATABASE START LOGICAL STANDBY APPLY IMMEDIATE` statement.

Real-time apply requires a standby database that is configured with a standby redo log and that is in ARCHIVELOG mode.

[Figure 8-1](#) shows an Oracle Data Guard configuration with a local destination and a standby destination. As the remote file server (RFS) process writes the redo data to standby redo log files on the standby database, apply services can recover redo from standby redo log files as they are being filled.

Figure 8-1 Applying Redo Data to a Standby Destination Using Real-Time Apply

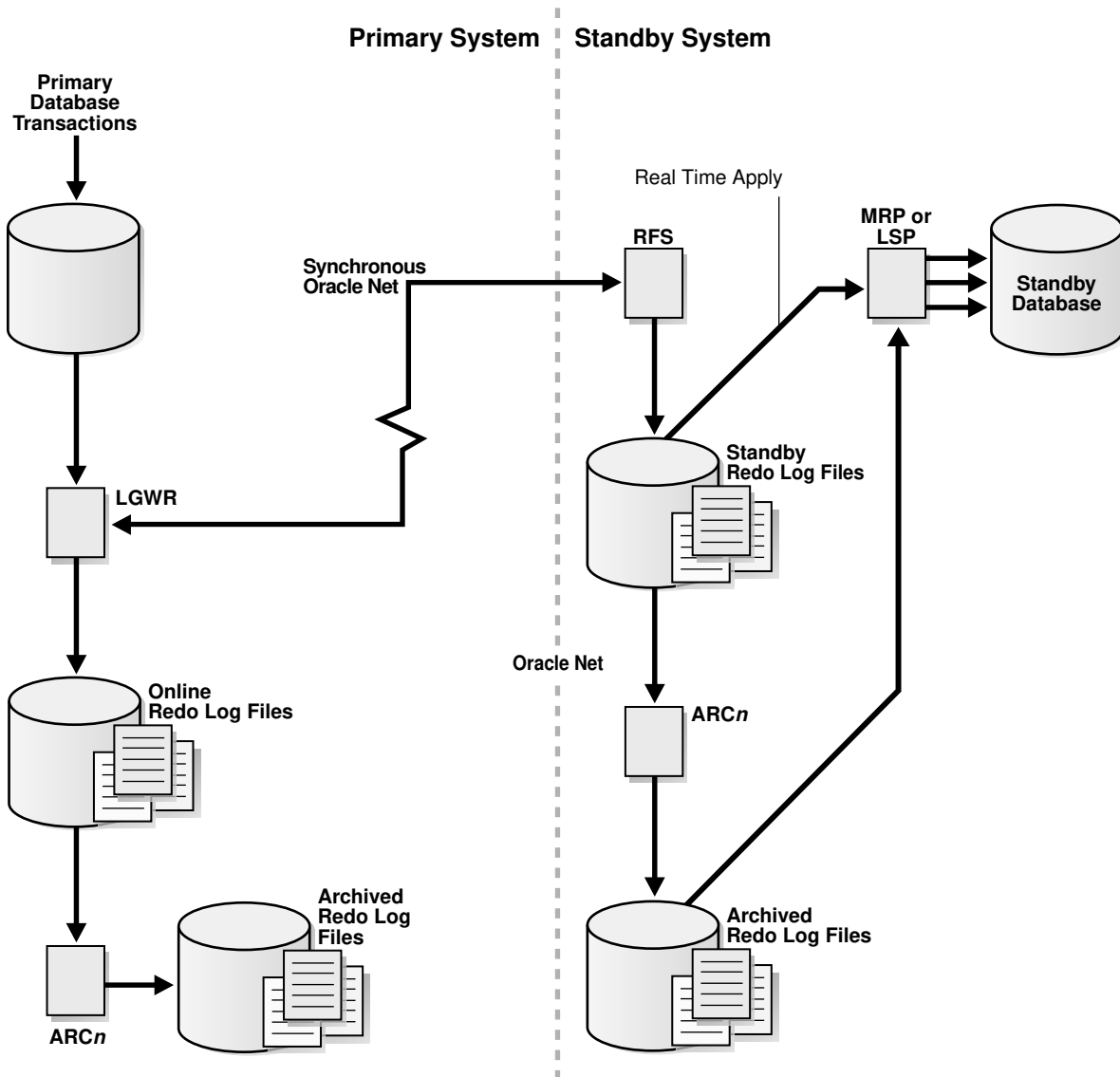

## 8.2.2 Specifying a Time Delay for the Application of Archived Redo Log Files

In some cases, you may want to create a time lag between the time when redo data is received from the primary site and when it is applied to the standby database.

You can specify a time interval (in minutes) to protect against the application of corrupted or erroneous data to the standby database. When you set a `DELAY` interval, it does not delay the transport of the redo data to the standby database. Instead, the time lag you specify begins when the redo data is completely archived at the standby destination.

 **Note:**

If you define a delay for a destination that has real-time apply enabled, the delay is ignored. If you define a delay as described in the following paragraph, then you must start the apply using the `USING ARCHIVED LOGFILE` clause as shown in [Starting Redo Apply](#).

### Specifying a Time Delay

You can set a time delay on primary and standby databases using the `DELAY=minutes` attribute of the `LOG_ARCHIVE_DEST_n` initialization parameter to delay applying archived redo log files to the standby database. By default, there is no time delay. If you specify the `DELAY` attribute without specifying a value, then the default delay interval is 30 minutes.

### Canceling a Time Delay

You can cancel a specified delay interval as follows:

- For physical standby databases, use the `NODELAY` keyword of the `RECOVER MANAGED STANDBY DATABASE` clause:

```
SQL> ALTER DATABASE RECOVER MANAGED STANDBY DATABASE NODELAY;
```

- For logical standby databases, specify the following SQL statement:

```
SQL> ALTER DATABASE START LOGICAL STANDBY APPLY NODELAY;
```

These commands result in apply services immediately beginning to apply archived redo log files to the standby database, before the time interval expires.

## 8.2.2.1 Using Flashback Database as an Alternative to Setting a Time Delay

As an alternative to setting an apply delay, you can use Flashback Database to recover from the application of corrupted or erroneous data to the standby database.

Flashback Database can quickly and easily flash back a standby database to an arbitrary point in time.

See [Oracle Data Guard Scenarios](#) for scenarios showing how to use Oracle Data Guard with Flashback Database, and *Oracle Database Backup and Recovery User's Guide* for more information about enabling and using Flashback Database.

## 8.3 Applying Redo Data to Physical Standby Databases

When performing Redo Apply, a physical standby database can use the real-time apply feature to apply redo directly from the standby redo log files as they are being written by the remote file server (RFS) process.

This section contains the following topics:

- [Starting Redo Apply](#)
- [Stopping Redo Apply](#)
- [Monitoring Redo Apply on Physical Standby Databases](#)



## 8.3.1 Starting Redo Apply

To start apply services on a physical standby database, ensure the physical standby database is started and mounted and then start Redo Apply.

Start apply services on a physical standby database as follows:

```
SQL> ALTER DATABASE RECOVER MANAGED STANDBY DATABASE;
```

This also automatically enables real-time apply provided the standby database is configured with a standby redo log and is in ARCHIVELOG mode.

Redo Apply can be run either as a foreground session or as a background process. To start Redo Apply in the foreground, issue the following SQL statement:

```
SQL> ALTER DATABASE RECOVER MANAGED STANDBY DATABASE;
```

If you start a foreground session, control is not returned to the command prompt until recovery is canceled by another session.

To start Redo Apply in the background, include the DISCONNECT keyword on the SQL statement. For example:

```
SQL> ALTER DATABASE RECOVER MANAGED STANDBY DATABASE DISCONNECT;
```

or

```
SQL> ALTER DATABASE RECOVER MANAGED STANDBY DATABASE USING ARCHIVED LOGFILE  
DISCONNECT;
```

This statement starts a detached server process and immediately returns control to the user. While the managed recovery process is performing recovery in the background, the foreground process that issued the RECOVER statement can continue performing other tasks. This command does not disconnect the current SQL session.

## 8.3.2 Stopping Redo Apply

Use an ALTER DATABASE SQL statement to stop Redo Apply.

For example, issue the following SQL statement:

```
SQL> ALTER DATABASE RECOVER MANAGED STANDBY DATABASE CANCEL;
```

## 8.3.3 Monitoring Redo Apply on Physical Standby Databases

You can monitor the status of apply services on a physical standby database.

See [Using Views to Monitor Primary\\_ Physical\\_ and Snapshot Standby Databases](#). You can also monitor the standby database using Oracle Enterprise Manager Cloud Control.

## 8.4 Applying Redo Data to Logical Standby Databases

SQL Apply converts the data from the archived redo log or standby redo log into SQL statements and then executes these SQL statements on the logical standby database.

Because the logical standby database remains open, tables that are maintained can be used simultaneously for other tasks such as reporting, summations, and queries.

See the following topics:

- [Starting SQL Apply](#)
- [Stopping SQL Apply on a Logical Standby Database](#)
- [Monitoring SQL Apply on Logical Standby Databases](#)

## 8.4.1 Starting SQL Apply

Use an `ALTER DATABASE SQL` statement to start SQL Apply.

For example, to start SQL Apply, start the logical standby database and issue the following statement:

```
SQL> ALTER DATABASE START LOGICAL STANDBY APPLY;
```

To start real-time apply on the logical standby database to immediately apply redo data from the standby redo log files on the logical standby database, include the `IMMEDIATE` keyword as shown in the following statement:

```
SQL> ALTER DATABASE START LOGICAL STANDBY APPLY IMMEDIATE;
```

## 8.4.2 Stopping SQL Apply on a Logical Standby Database

Use an `ALTER DATABASE SQL` statement to stop SQL Apply on a logical standby database.

For example, issue the following statement on the logical standby database:

```
SQL> ALTER DATABASE STOP LOGICAL STANDBY APPLY;
```

When you issue this statement, SQL Apply waits until it has committed all complete transactions that were in the process of being applied. Thus, this command may not stop the SQL Apply processes immediately.

## 8.4.3 Monitoring SQL Apply on Logical Standby Databases

There are views that provide information you can use to manage and monitor SQL Apply on logical standby databases.

See [Views Related to Managing and Monitoring a Logical Standby Database](#). You can also monitor the standby database using Oracle Enterprise Manager Cloud Control. See [Troubleshooting Oracle Data Guard](#).

# 8.5 Standby Considerations When Removing or Renaming a PDB at a Primary

Restrictions apply when you are removing or renaming a pluggable database (PDB) at the primary, if the primary is a multitenant container database (CDB).

- To perform DDL `UNPLUG` and `DROP` operations on a PDB, the PDB must first be closed on the primary as well as on all standby databases.

- To perform a DDL `RENAME` operation on a PDB, the PDB must first be put in open restricted mode on the primary, and closed on all standby databases.

If you do not close the PDB at the standby before removing it or renaming it at the primary database, then the standby stops the recovery process for all PDBs. You must close the dropped PDB at the standby and then restart recovery using the following SQL statement:

```
SQL> ALTER DATABASE RECOVER MANAGED STANDBY DATABASE;
```

# 9

## Role Transitions

An Oracle Data Guard configuration consists of one database that functions in the primary role and one or more databases that function in the standby role.

To see the current role of the databases, query the `DATABASE_ROLE` column in the `V$DATABASE` view.

The number, location, and type of standby databases in an Oracle Data Guard configuration and the way in which redo data from the primary database is propagated to each standby database determine the role-management options available to you in response to a primary database outage.

See the following topics for information about how to manage role transitions in an Oracle Data Guard configuration:

- [Introduction to Role Transitions](#)
- [Role Transitions Involving Physical Standby Databases](#)
- [Role Transitions Involving Logical Standby Databases](#)
- [Using Flashback Database After a Role Transition](#)

### Note:

These topics describe how to perform role transitions manually, using SQL statements. Do not use these manual procedures to perform role transitions in an Oracle Data Guard configuration that is managed by the broker. Use the role transition procedures provided in *Oracle Data Guard Broker* instead.

### See Also:

*Oracle Data Guard Broker* for information about using the Oracle Data Guard broker to:

- Simplify switchovers and failovers by allowing you to invoke them using either a single key click in Oracle Enterprise Manager Cloud Control or a single command in the DGMGRL command-line interface.
- Enable **fast-start failover** to fail over *automatically* when the primary database becomes unavailable. When fast-start failover is enabled, the Oracle Data Guard broker determines if a failover is necessary and initiates the failover to the specified target standby database automatically, with no need for DBA intervention.

## 9.1 Introduction to Role Transitions

A database operates in one of the following mutually exclusive roles: **primary** or **standby**.

Oracle Data Guard enables you to change these roles dynamically by using SQL statements, or by using either of the Oracle Data Guard broker's interfaces. Oracle Data Guard supports the following role transitions:

- **Switchover**  
Allows the primary database to switch roles with one of its standby databases. There is no data loss during a switchover. After a switchover, each database continues to participate in the Oracle Data Guard configuration with its new role.
- **Failover**  
Changes a standby database to the primary role in response to a primary database failure. If the primary database was not operating in either maximum protection mode or maximum availability mode before the failure, some data loss may occur. If Flashback Database is enabled on the primary database, it can be reinstated as a standby for the new primary database once the reason for the failure is corrected.

### See Also:

- [Preparing for a Role Transition](#) for information that helps you choose the role transition that best minimizes downtime and risk of data loss
- [Switchovers](#) for more information about switchovers.
- [Failovers](#) for more information about failovers
- *Oracle Data Guard Broker* for information about event notification and database connection failover support available to database clients when a broker-managed failover occurs

### 9.1.1 Preparing for a Role Transition

Before starting any role transitions, you must verify that each database is properly configured and that there are no redo transport errors or redo gaps at the standby database.

- Verify that each database is properly configured for the role that it is about to assume. See [Creating a Physical Standby Database](#) and [Creating a Logical Standby Database](#) for information about how to configure database initialization parameters, ARCHIVELOG mode, standby redo logs, and online redo logs on primary and standby databases.

 **Note:**

You must define the `LOG_ARCHIVE_DEST_n` and `LOG_ARCHIVE_DEST_STATE_n` parameters on each standby database so that when a switchover or failover occurs, all standby sites continue to receive redo data from the new primary database.

- Verify that there are no redo transport errors or redo gaps at the standby database by querying the `V$ARCHIVE_DEST_STATUS` view on the primary database.

For example, the following query would be used to check the status of the standby database associated with `LOG_ARCHIVE_DEST_2`:

```
SQL> SELECT STATUS, GAP_STATUS FROM V$ARCHIVE_DEST_STATUS WHERE DEST_ID = 2;
```

```
STATUS GAP_STATUS
```

```
-----  
VALID NO GAP
```

Do not proceed until the value of the `STATUS` column is `VALID` and the value of the `GAP_STATUS` column is `NOGAP`, for the row that corresponds to the standby database.

- Ensure temporary files exist on the standby database that match the temporary files on the primary database.
- Remove any delay in applying redo that may be in effect on the standby database that is set to become the new primary database. Not removing the delay results in a longer switchover time, and may cause the switchover to be disallowed.
- Before performing a switchover to a physical standby database that is in real-time query mode, consider bringing all instances of that standby database to the mounted but not open state to achieve the fastest possible role transition and to cleanly terminate any user sessions connected to the physical standby database prior to the role transition.
- When you perform a switchover from an Oracle RAC primary database to a physical standby database, *it is not necessary* to shut down all but one primary database instance.

## 9.1.2 Choosing a Target Standby Database for a Role Transition

For an Oracle Data Guard configuration with multiple standby databases, there are a number of factors to consider when choosing the target standby database for a role transition.

These include the following:

- Locality of the standby database.
- The capability of the standby database (hardware specifications—such as the number of CPUs, I/O bandwidth available, and so on).
- The time it takes to perform the role transition. This is affected by how far behind the standby database is in applying redo data, and how much flexibility you have in terms of trading off application availability with data loss.
- Standby database type.

The type of standby chosen as the role transition target determines how other standby databases in the configuration behave after the role transition. If the new primary was a physical standby before the role transition, then all other standby databases in the configuration become standbys of the new primary. If the new primary was a logical standby before the role transition, then all other logical standbys in the configuration become standbys of the new primary, but physical standbys in the configuration continue to be standbys of the old primary and therefore, do not protect the new primary. In the latter case, a future switchover or failover back to the original primary database returns all standbys to their original role as standbys of the current primary. For the reasons described above, a physical standby is generally the best role transition target in a configuration that contains both physical and logical standbys.



#### Note:

A snapshot standby cannot be the target of a role transition. To use a snapshot standby database as a target for a role transition, first convert it to a physical standby database and allow all redo received from the primary database to be applied. See [Converting a Snapshot Standby Database into a Physical Standby Database](#).

Oracle Data Guard provides the `V$DATAGUARD_STATS` view, which you can use to evaluate each standby database in terms of the currency of the data in the standby database, and the time needed to perform a role transition if all available redo data is applied to the standby database. For example:

```
SQL> COLUMN NAME FORMAT A24
SQL> COLUMN VALUE FORMAT A16
SQL> COLUMN DATUM_TIME FORMAT A24
SQL> SELECT NAME, VALUE, DATUM_TIME FROM V$DATAGUARD_STATS;
```

NAME	VALUE	DATUM_TIME
transport lag	+00 00:00:00	06/18/2009 12:22:06
apply lag	+00 00:00:00	06/18/2009 12:22:06
apply finish time	+00 00:00:00.000	
estimated startup time	9	

This query output shows that the standby database has received and applied all redo generated by the primary database. These statistics were computed using data received from the primary database as of 12:22.06 on 06/18/09.

The `apply lag` and `transport lag` metrics are computed based on data received from the primary database. These metrics become stale if communications between the primary and standby database are disrupted. An unchanging value in the `DATUM_TIME` column for the `apply lag` and `transport lag` metrics indicates that these metrics are not being updated and have become stale, possibly due to a communications fault between the primary and standby databases.

## 9.1.3 Switchovers

A switchover is typically used to reduce primary database downtime during planned outages.

Planned outages are events such as operating system or hardware upgrades, or rolling upgrades of the Oracle database software and patch sets.

A switchover takes place in two phases. In the first phase, the existing primary database undergoes a transition to a standby role. In the second phase, a standby database undergoes a transition to the primary role.

Figure 9-1 shows a two-site Oracle Data Guard configuration before the roles of the databases are switched. The primary database is in San Francisco, and the standby database is in Boston.

**Figure 9-1 Oracle Data Guard Configuration Before Switchover**

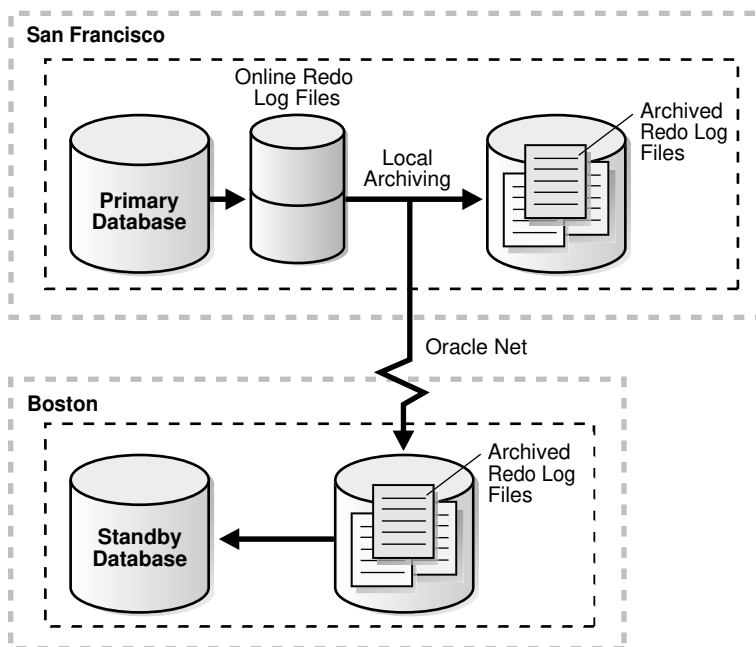

Figure 9-2 shows the Oracle Data Guard environment after the original primary database was switched over to a standby database, but before the original standby database has become the new primary database. At this stage, the Oracle Data Guard configuration temporarily has two standby databases.



**Figure 9-2 Standby Databases Before Switchover to the New Primary Database**

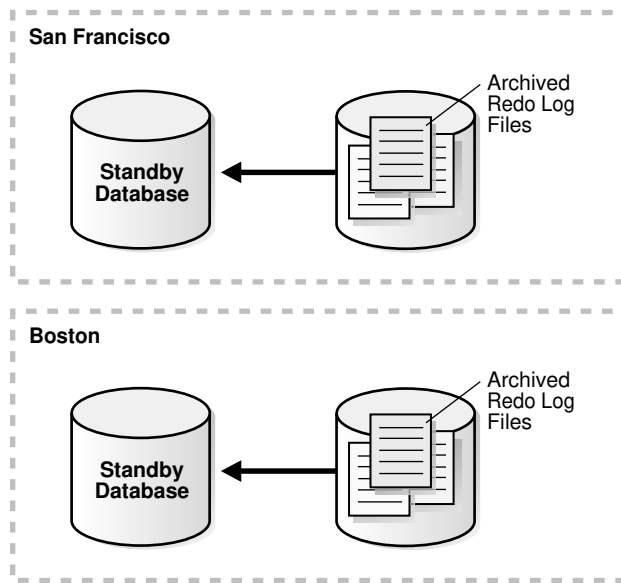
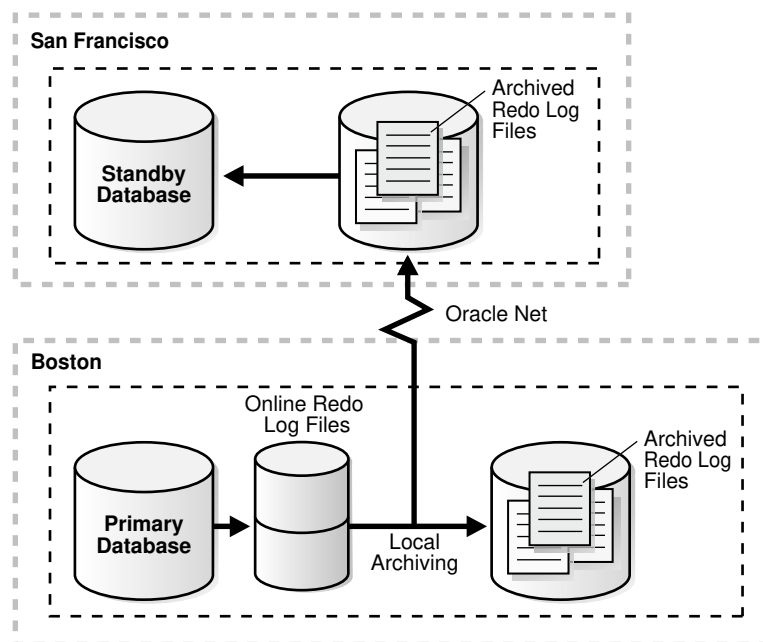

Figure 9-3 shows the Oracle Data Guard environment after a switchover took place. The original standby database became the new primary database. The primary database is now in Boston, and the standby database is now in San Francisco.

**Figure 9-3 Oracle Data Guard Environment After Switchover**



### Preparing for a Switchover

Ensure the prerequisites listed in [Preparing for a Role Transition](#) are satisfied. In addition, the following prerequisites must be met for a switchover:

- For switchovers involving a physical standby database, verify that the primary database is open and that Redo Apply is active on the standby database.
- For switchovers involving a logical standby database, verify that both the primary and standby database instances are open and that SQL Apply is active.

 **See Also:**

- [Using SQL Apply to Upgrade the Oracle Database](#)
- [Applying Redo Data to Physical Standby Databases](#) for more information about Redo Apply
- [Applying Redo Data to Logical Standby Databases](#) for more information about SQL Apply

## 9.1.4 Failovers

A failover is typically used only when the primary database becomes unavailable, and there is no possibility of restoring it to service within a reasonable period of time.

The specific actions performed during a failover vary based on whether a logical or a physical standby database is involved in the failover, the state of the Oracle Data Guard configuration at the time of the failover, and on the specific SQL statements used to initiate the failover.

[Figure 9-4](#) shows the result of a failover from a primary database in San Francisco to a physical standby database in Boston.

**Figure 9-4 Failover to a Standby Database**

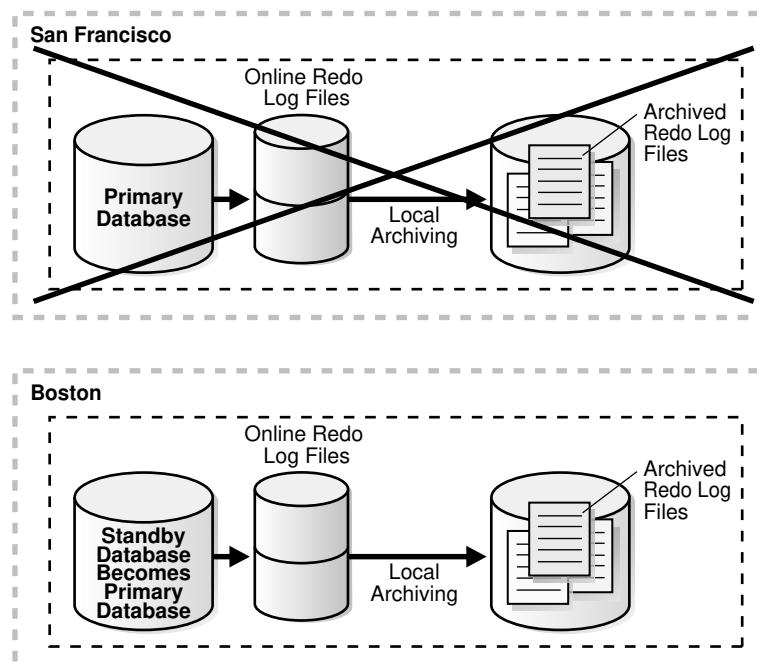

## Preparing for a Failover

 **Note:**

If managed standby recovery at a physical standby database chosen for failover has stopped with error ORA-752 or ORA-600 [3020], then proceed directly to [Recovering From Lost-Write Errors on a Primary Database](#).

If possible, before performing a failover, transfer as much of the available and unapplied primary database redo data as possible to the standby database.

Ensure the prerequisites listed in [Preparing for a Role Transition](#) are satisfied. In addition, the following prerequisites must be met for a failover:

- If a standby database currently running in maximum protection mode is involved in the failover, then first place it in maximum performance mode by issuing the following statement on the standby database:

```
SQL> ALTER DATABASE SET STANDBY DATABASE TO MAXIMIZE PERFORMANCE;
```

Then, if appropriate standby databases are available, you can reset the desired protection mode on the new primary database after the failover completes.

This is required because you cannot fail over to a standby database that is in maximum protection mode. In addition, if a primary database in maximum protection mode is still actively communicating with the standby database, then issuing the `ALTER DATABASE` statement to change the standby database from maximum protection mode to maximum performance mode does not succeed. Because a failover removes the original primary database from the Oracle Data Guard configuration, these features serve to protect a primary database operating in maximum protection mode from the effects of an unintended failover.

 **Note:**

Do not fail over to a standby database to test whether or not the standby database is being updated correctly. Instead:

- See [Verify the Physical Standby Database Is Performing Properly](#)
- See [Verify the Logical Standby Database Is Performing Properly](#)

## 9.1.5 Role Transition Triggers

The `DB_ROLE_CHANGE` system event is signaled whenever a role transition occurs.

This system event is signaled immediately if the database is open when the role transition occurs, or the next time the database is opened if it is closed when a role transition occurs.

The `DB_ROLE_CHANGE` system event can be used to fire a trigger that performs a set of actions whenever a role transition occurs.

## 9.2 Role Transitions Involving Physical Standby Databases

The procedures to perform switchovers and failovers to a physical standby database have been simplified if you are running Oracle Database 12c Release 1 (12.1) or later.

The former procedures are still supported, however Oracle recommends that you use the new procedures as described in the following sections:

- [Performing a Switchover to a Physical Standby Database](#)
- [Performing a Failover to a Physical Standby Database](#)

### Note:

As of Oracle Database 18c, the database buffer cache state is maintained on an Active Data Guard standby during a role transition so that application performance is not affected by physical blocks read from disk to populate the buffer cache. This results in improved application performance on the new primary after a role transition.

### Keeping Physical Standby Sessions Connected During Role Transition

As of Oracle Database 12c Release 2 (12.2.0.1), when a physical standby database is converted into a primary you have the option to keep any sessions connected to the physical standby connected, without disruption, during the switchover/failover.

To enable this feature, set the `STANDBY_DB_PRESERVE_STATES` initialization parameter in your `init.ora` file before the standby instance is started. This parameter applies to physical standby databases only. The allowed values are:

- `NONE` — No user sessions or current buffers on the standby are retained during a switchover/failover. This is the default value.
- `ALL` — Both user sessions and current buffers are retained during switchover/failover.
- `SESSION` — User sessions are retained during switchover/failover.
- `BUFFER` — Current buffers are retained during switchover/failover.

### See Also:

- [Troubleshooting Oracle Data Guard](#) for information about how to troubleshoot problems you might encounter when performing role transitions to a physical standby database
- [Performing Role Transitions Using Old Syntax](#) for information about the procedures used in prior releases, and a comparison of old and new syntax
- *Oracle Database Reference* for a complete description of the `STANDBY_DB_PRESERVE_STATES` initialization parameter.

## 9.2.1 Performing a Switchover to a Physical Standby Database

These steps describe how to perform a switchover to a physical standby database.

### Note:

If there is a far sync instance (or a combination of preferred and alternate far sync instances) connecting the primary and standby databases, then the procedure to switchover to the standby is the same as described in this topic. Whether the far sync instances are available or unavailable does not affect switchover. During switchover, the primary and standby must be able to communicate directly with each other and perform the switchover role transition steps oblivious of the far sync instances. See “Using Far Sync Instances” in *Oracle Data Guard Concepts and Administration* for examples of how to set up such configurations correctly so that the far sync instances can service the new roles of the two databases after switchover.

1. Verify that the target standby database is ready for switchover.

The new switchover statement has a `VERIFY` option that results in checks being performed of many conditions required for switchover. Some of the items checked are: whether Redo Apply is running on the switchover target; whether the release version of the switchover target is 12.1 or later; whether the switchover target is synchronized; and whether it has MRP running.

Suppose the primary database has a `DB_UNIQUE_NAME` of `BOSTON` and the switchover target standby database has a `DB_UNIQUE_NAME` of `CHICAGO`. On the primary database `BOSTON`, issue the following SQL statement to verify that the switchover target, `CHICAGO`, is ready for switchover:

```
SQL> ALTER DATABASE SWITCHOVER TO CHICAGO VERIFY;  
ERROR at line 1:  
ORA-16470: Redo Apply is not running on switchover target
```

If this operation had been successful, a `Database Altered` message would have been returned but in this example an `ORA-16470` error was returned. This error means that the switchover target `CHICAGO` is not ready for switchover. Redo Apply must be started before the switchover operation.

After Redo Apply is started, issue the following statement again:

```
SQL> ALTER DATABASE SWITCHOVER TO CHICAGO VERIFY;  
ERROR at line 1:  
ORA-16475: succeeded with warnings, check alert log for more details
```

The switchover target, `CHICAGO`, is ready for switchover. However, the warnings indicated by the `ORA-16475` error may affect switchover performance. The alert log contains messages similar to the following:

```
SWITCHOVER VERIFY WARNING: switchover target has dirty online redo logfiles  
that require clearing. It takes time to clear online redo logfiles. This may  
slow down switchover process.
```

You can fix the problems or if switchover performance is not important, those warnings can be ignored. After making any fixes you determine are necessary, issue the following SQL statement again:

```
SQL> ALTER DATABASE SWITCHOVER TO CHICAGO VERIFY;
Database altered.
```

The switchover target, CHICAGO, is now ready for switchover.

2. Initiate the switchover on the primary database, BOSTON, by issuing the following SQL statement:

```
SQL> ALTER DATABASE SWITCHOVER TO CHICAGO;
Database altered.
```

If this statement completes without any errors, proceed to Step 3.

If an error occurs, mount the old primary database (BOSTON) and the old standby database (CHICAGO). On both databases, query DATABASE\_ROLE from V\$DATABASE. There are three possible combinations of database roles for BOSTON and CHICAGO. The following table describes these combinations and provides the likely cause and a high level remedial action for each situation. For details on specific error situations, see “Troubleshooting Oracle Data Guard” in *Oracle Data Guard Concepts and Administration*.

Value of DATABASE_ROLE column in V\$DATABASE	Cause and Remedial Action
BOSTON database is primary, CHICAGO database is standby	<p>Cause: The BOSTON database failed to convert to a standby database role.</p> <p>Action: See the alert log for details on the error that prevented BOSTON from switching to a standby role, take the necessary actions to fix the error, reopen one of the nodes of BOSTON if necessary, and repeat the switchover process from Step 1.</p>

Value of DATABASE_ROLE column in V\$DATABASE	Cause and Remedial Action
<p>BOSTON database is standby, CHICAGO database is standby</p>	<p>Cause: The CHICAGO database failed to convert to a primary database role.</p> <p>Action: Issue the following SQL statement to convert either BOSTON or CHICAGO to a primary database:</p> <pre>SQL&gt; ALTER DATABASE SWITCHOVER TO target_db_name FORCE;</pre> <p>For example:</p> <ul style="list-style-type: none"> <li>On the CHICAGO database, issue the following SQL statement to convert it to a primary database: <pre>ALTER DATABASE SWITCHOVER TO CHICAGO FORCE;</pre> </li> <li>On the BOSTON database, issue the following SQL statement to convert it to a primary database: <pre>ALTER DATABASE SWITCHOVER TO BOSTON FORCE;</pre> </li> </ul> <p>If the SQL statement fails with an ORA-16473 error, then you must start Redo Apply before reissuing the command.</p> <p>Restart Redo Apply as follows:</p> <pre>SQL&gt; ALTER DATABASE RECOVER MANAGED STANDBY DATABASE DISCONNECT;</pre> <p>Reissue the switchover command as follows:</p> <pre>SQL&gt; ALTER DATABASE SWITCHOVER TO BOSTON FORCE; Database altered.</pre>
<p>BOSTON database is standby, CHICAGO database is primary</p>	<p>Cause: The BOSTON and CHICAGO databases have successfully switched to their new roles, but there was an error communicating the final success status back to BOSTON.</p> <p>Action: Continue to Step 3 to finish the switchover operation.</p>

- Issue the following SQL statement on the new primary database, CHICAGO, to open it.

```
SQL> ALTER DATABASE OPEN;
```

- Issue the following SQL statement to mount the new physical standby database, BOSTON:

```
SQL> STARTUP MOUNT;
```

Or, if BOSTON is an Oracle Active Data Guard physical standby database, then issue the following SQL statement to open it read only:

```
SQL> STARTUP;
```

- Start Redo Apply on the new physical standby database. For example:

```
SQL> ALTER DATABASE RECOVER MANAGED STANDBY DATABASE DISCONNECT FROM SESSION;
```

**Related Topics**

- [Troubleshooting Oracle Data Guard](#)

These are some of the problems that can occur on a standby database, and the troubleshooting procedures to address them.

**Related Topics**

- [Using Far Sync Instances](#)

An Oracle Data Guard far sync instance is a remote Oracle Data Guard destination that accepts redo from the primary database and then ships that redo to other members of the Oracle Data Guard configuration.

## 9.2.2 Performing a Failover to a Physical Standby Database

These steps describe how to perform a failover to a physical standby database.

1. If the primary database can be mounted, then flush any unsent archived and current redo from the primary database to the standby database. If this operation is successful, a zero data loss failover is possible even if the primary database is not in a zero data loss data protection mode.

First, ensure that Redo Apply is active at the target standby database. Then mount, but do not open the primary database. If the primary database cannot be mounted, go to Step 2.

If not already done, then set up the remote `LOG_ARCHIVE_DEST_n` configured at the primary to point to the target destination. (You may not have any remote `LOG_ARCHIVE_DEST_n` configured if the target destination was serviced by a far sync instance, or was a terminal standby in a cascaded configuration.) Also, ensure that the primary can connect to the target destination by verifying that the `NET_ALIAS_TARGET_DB_NAME` is valid and properly established.

```
SQL> ALTER SYSTEM SET LOG_ARCHIVE_DEST_6='SERVICE=NET_ALIAS_TARGET_DB_NAME -
> ASYNC VALID_FOR=(online_logfile, primary_role) -
> DB_UNIQUE_NAME="target_db_unique_name" ' SCOPE=memory;
```

```
SQL> ALTER SYSTEM SET LOG_ARCHIVE_DEST_STATE_6=ENABLE;
```

It is also assumed that the `LOG_ARCHIVE_CONFIG` specification includes the `DB_UNIQUE_NAME` of the target destination at the primary (and `LOG_ARCHIVE_CONFIG` at the target destination includes the `DB_UNIQUE_NAME` of the primary). If not, then add that information to the `LOG_ARCHIVE_CONFIG` at the primary and target destination as required.

Issue the following SQL statement at the primary database:

```
SQL> ALTER SYSTEM FLUSH REDO TO target_db_name;
```

For `target_db_name`, specify the `DB_UNIQUE_NAME` of the standby database that is to receive the redo flushed from the primary database.

This statement flushes any unsent redo from the primary database to the standby database, and waits for that redo to be applied to the standby database.

If this statement completes without any errors, go to Step 5. If the statement completes with any error, or if it must be stopped because you cannot wait any longer for the statement to complete, continue with Step 2.

2. Query the `V$ARCHIVED_LOG` view on the target standby database to obtain the highest log sequence number for each redo thread.



For example:

```
SQL> SELECT UNIQUE THREAD# AS THREAD, MAX(SEQUENCE#) -
> OVER (PARTITION BY thread#) AS LAST from V$ARCHIVED_LOG;
```

THREAD	LAST
1	100

If possible, copy the most recently archived redo log file for each primary database redo thread to the standby database if it does not exist there, and register it. This must be done for each redo thread.

For example:

```
SQL> ALTER DATABASE REGISTER PHYSICAL LOGFILE 'filespec1';
```

3. Query the V\$ARCHIVE\_GAP view on the target standby database to determine if there are any redo gaps on the target standby database.

For example:

```
SQL> SELECT THREAD#, LOW_SEQUENCE#, HIGH_SEQUENCE# FROM V$ARCHIVE_GAP;
```

THREAD#	LOW_SEQUENCE#	HIGH_SEQUENCE#
1	90	92

In this example, the gap comprises archived redo log files with sequence numbers 90, 91, and 92 for thread 1.

If possible, copy any missing archived redo log files to the target standby database from the primary database and register them at the target standby database. This must be done for each redo thread.

For example:

```
SQL> ALTER DATABASE REGISTER PHYSICAL LOGFILE 'filespec1';
```

4. The query executed in Step 3 displays information for the highest gap only. After resolving a gap, you must repeat the query until no more rows are returned.

If, after performing Step 2 through Step 4, you are not able to resolve all gaps in the archived redo log files (for example, because you do not have access to the system that hosted the failed primary database), then you can expect some data loss during the failover.

5. Issue the following SQL statement on the target standby database:

```
SQL> ALTER DATABASE RECOVER MANAGED STANDBY DATABASE CANCEL;
```

6. Issue the following SQL statement on the target standby database:

```
SQL> ALTER DATABASE FAILOVER TO target_db_name;
```

For example, suppose the target standby database is named CHICAGO:

```
SQL> ALTER DATABASE FAILOVER TO CHICAGO;
```

If this statement completes without any errors, proceed to Step 10.

If there are errors, go to Step 7.

7. If an error occurs, try to resolve the cause of the error and then reissue the statement.

- If successful, go to Step 10.
  - If the error still occurs and it involves a far sync instance, go to Step 8.
  - If the error still occurs and there is no far sync instance involved, go to Step 9.
8. This step is for far sync instance error cases only. If the error involves a far sync instance (for example, it is unavailable) and you have tried resolving the issue and reissuing the statement without success, then you can use the `FORCE` option. For example:

```
SQL> ALTER DATABASE FAILOVER TO CHICAGO FORCE;
```

The `FORCE` option instructs the failover to ignore any failures encountered when interacting with the far sync instance and proceed with the failover, if at all possible. (The `FORCE` option has meaning only when the failover target is serviced by a far sync instance.)

If the `FORCE` option is successful, go to Step 10.

If the `FORCE` option is unsuccessful, go to Step 9.

9. Perform a data loss failover.

If an error condition cannot be resolved, a failover can still be performed (with some data loss) by issuing the following SQL statement on the target standby database:

```
SQL> ALTER DATABASE ACTIVATE PHYSICAL STANDBY DATABASE;
```

In the following example, the failover operation fails with an `ORA-16472` error. That error means the database is configured in `MaxAvailability` or `MaxProtection` mode but data loss is detected during failover.

```
SQL> ALTER DATABASE FAILOVER TO CHICAGO;
ERROR at line 1:
ORA-16472: failover failed due to data loss
```

You can complete the data loss failover by issuing the following SQL statement:

```
SQL> ALTER DATABASE ACTIVATE PHYSICAL STANDBY DATABASE;
Database altered.
```

10. Open the new primary database:

```
SQL> ALTER DATABASE OPEN;
```

11. Oracle recommends that you perform a full backup of the new primary database.
12. If Redo Apply has stopped at any of the other physical standby databases in your Data Guard configuration, then restart it. For example:

```
SQL> ALTER DATABASE RECOVER MANAGED STANDBY DATABASE DISCONNECT;
```

13. After a failover, the original primary database can be converted into a physical standby database of the new primary database using the method described in [Converting a Failed Primary Into a Standby Database Using Flashback Database](#) or [Converting a Failed Primary into a Standby Database Using RMAN Backups](#), or it can be re-created as a physical standby database from a backup of the new primary database using the method described in [Step-by-Step Instructions for Creating a Physical Standby Database](#).

Once the original primary database is running in the standby role, a switchover can be performed to restore it to the primary role.

## 9.3 Role Transitions Involving Logical Standby Databases

Role transition steps differ depending on whether you are performing a switchover or a failover.

See the following topics for information on how to perform switchovers and failovers involving a logical standby database:

- [Performing a Switchover to a Logical Standby Database](#)
- [Performing a Failover to a Logical Standby Database](#)

### Note:

Logical standby does not replicate database services. In the event of a failover or switchover to a logical standby, mid-tiers connecting to services in the primary are not able to connect (since the creation of the service is not replicated), or connect to an incorrect edition (since the modification of the service attribute is not replicated).

Oracle Clusterware does not replicate the services it manages to logical standbys. You must manually keep them synchronized between the primary and standby. See *Oracle Clusterware Administration and Deployment Guide* for more information about Oracle Clusterware.

### 9.3.1 Performing a Switchover to a Logical Standby Database

When you perform a switchover that changes roles between a primary database and a logical standby database, always initiate the switchover on the primary database and complete it on the logical standby database.

For the switchover to succeed, these steps must be performed in the order in which they are described.

1. On the current primary database, query the `SWITCHOVER_STATUS` column of the `V$DATABASE` fixed view on the primary database to verify it is possible to perform a switchover.

For example:

```
SQL> SELECT SWITCHOVER_STATUS FROM V$DATABASE;

SWITCHOVER_STATUS
-----
TO STANDBY
1 row selected
```

A value of `TO STANDBY` or `SESSIONS ACTIVE` in the `SWITCHOVER_STATUS` column indicates that it is possible to switch the primary database to the logical standby role. If one of these values is not displayed, then verify the Oracle Data Guard configuration is functioning correctly (for example, verify all `LOG_ARCHIVE_DEST_n` parameter values are specified correctly). See *Oracle Database Reference* for information about other valid values for the `SWITCHOVER_STATUS` column of the `V$DATABASE` view.

2. To prepare the current primary database for a logical standby database role, issue the following SQL statement on the primary database:

```
SQL> ALTER DATABASE PREPARE TO SWITCHOVER TO LOGICAL STANDBY;
```

This statement notifies the current primary database that it will soon switch to the logical standby role and begin receiving redo data from a new primary database. You perform this step on the primary database in preparation to receive the LogMiner dictionary to be recorded in the redo stream of the current logical standby database, as described in Step 3.

The value `PREPARING SWITCHOVER` is displayed in the `V$DATABASE.SWITCHOVER_STATUS` column if this operation succeeds.

3. Use the following statement to build a LogMiner dictionary on the logical standby database that is the target of the switchover:

```
SQL> ALTER DATABASE PREPARE TO SWITCHOVER TO PRIMARY;
```

This statement also starts redo transport services on the logical standby database that begins transmitting its redo data to the current primary database and to other standby databases in the Oracle Data Guard configuration. The sites receiving redo data from this logical standby database accept the redo data but they do not apply it.

The `V$DATABASE.SWITCHOVER_STATUS` on the logical standby database initially shows `PREPARING DICTIONARY` while the LogMiner dictionary is being recorded in the redo stream. Once this has completed successfully, the `SWITCHOVER_STATUS` column shows `PREPARING SWITCHOVER`.

4. Before you can complete the role transition of the primary database to the logical standby role, verify the LogMiner dictionary was received by the primary database by querying the `SWITCHOVER_STATUS` column of the `V$DATABASE` fixed view on the primary database. Without the receipt of the LogMiner dictionary, the switchover cannot proceed, because the current primary database must be able to interpret the redo records sent from the future primary database. The `SWITCHOVER_STATUS` column shows the progress of the switchover.

When the query returns the `TO LOGICAL STANDBY` value, you can proceed with Step 5. For example:

```
SQL> SELECT SWITCHOVER_STATUS FROM V$DATABASE;
```

```
SWITCHOVER_STATUS
-----
TO LOGICAL STANDBY
1 row selected
```

 **Note:**

You can cancel the switchover operation by issuing the following statements in the order shown:

- a. Cancel switchover on the primary database:

```
SQL> ALTER DATABASE PREPARE TO SWITCHOVER CANCEL;
```

- b. Cancel the switchover on the logical standby database:

```
SQL> ALTER DATABASE PREPARE TO SWITCHOVER CANCEL;
```

5. To complete the role transition of the primary database to a logical standby database, issue the following SQL statement:

```
SQL> ALTER DATABASE COMMIT TO SWITCHOVER TO LOGICAL STANDBY;
```

This statement waits for all current transactions on the primary database to end, prevents any new users from starting new transactions, and establishes a point in time for the switchover to be committed.

Executing this statement also prevents users from making any changes to the data being maintained in the logical standby database. To ensure faster execution, ensure the primary database is in a quiet state with no update activity before issuing the switchover statement (for example, have all users temporarily log off the primary database). You can query the `V$TRANSACTION` view for information about the status of any current in-progress transactions that could delay execution of this statement.

The primary database has now undergone a role transition to run in the standby database role.

When a primary database undergoes a role transition to a logical standby database role, you do not have to shut down and restart the database.

6. After you complete the role transition of the primary database to the logical standby role and the switchover notification is received by the standby databases in the configuration, verify the switchover notification was processed by the target standby database by querying the `SWITCHOVER_STATUS` column of the `V$DATABASE` fixed view on the target standby database. Once all available redo records are applied to the logical standby database, SQL Apply automatically shuts down in anticipation of the expected role transition.

The `SWITCHOVER_STATUS` value is updated to show progress during the switchover. When the status is `TO PRIMARY`, you can proceed with Step 7.

For example:

```
SQL> SELECT SWITCHOVER_STATUS FROM V$DATABASE;
```

```
SWITCHOVER_STATUS
-----
TO PRIMARY
1 row selected
```

See *Oracle Database Reference* for information about other valid values for the `SWITCHOVER_STATUS` column of the `V$DATABASE` view.

7. On the logical standby database that you want to switch to the primary role, use the following SQL statement to switch the logical standby database to the primary role:

```
SQL> ALTER DATABASE COMMIT TO SWITCHOVER TO PRIMARY;
```

There is no need to shut down and restart any logical standby databases that are in the Oracle Data Guard configuration. As described in [Choosing a Target Standby Database for a Role Transition](#), all other logical standbys in the configuration become standbys of the new primary, but any physical standby databases remain standbys of the original primary database.

8. On the new logical standby database, start SQL Apply:

```
SQL> ALTER DATABASE START LOGICAL STANDBY APPLY IMMEDIATE;
```

## 9.3.2 Performing a Failover to a Logical Standby Database

A failover role transition involving a logical standby database necessitates taking corrective actions on the failed primary database and on all bystander logical standby databases.

This topic describes how to perform failovers involving a logical standby database. If Flashback Database was not enabled on the failed primary database, you must re-create the database from backups taken from the current primary database. Otherwise, you can follow the procedure described in [Converting a Failed Primary Into a Standby Database Using Flashback Database](#) to convert a failed primary database to be a logical standby database for the new primary database.

Depending on the protection mode for the configuration and the attributes you chose for redo transport services, it might be possible to automatically recover all or some of the primary database modifications.

1. If the primary database can be mounted, then flush any unsent archived and current redo from the primary database to the standby database. If this operation is successful, a zero data loss failover is possible even if the primary database is not in a zero data loss data protection mode.

First, ensure that Redo Apply is active at the target standby database. Then mount, but do not open the primary database.

Issue the following SQL statement at the primary database:

```
SQL> ALTER SYSTEM FLUSH REDO TO target_db_name;
```

For `target_db_name`, specify the `DB_UNIQUE_NAME` of the standby database that is to receive the redo flushed from the primary database.

This statement flushes any unsent redo from the primary database to the standby database, and waits for that redo to be applied to the standby database.

2. Depending on the condition of the components in the configuration, you might have access to the archived redo log files on the primary database. If so, do the following:
  - a. Determine if any archived redo log files are missing on the logical standby database.
  - b. Copy missing log files from the primary database to the logical standby database.

c. Register the copied log files.

You can register an archived redo log file with the logical standby database by issuing the following statement, for example:

```
SQL> ALTER DATABASE REGISTER LOGICAL LOGFILE -  
> '/disk1/oracle/dbs/log-%r_%s_%t.arc';  
Database altered.
```

3. If you have not previously configured role-based destinations, identify the initialization parameters that correspond to the remote logical standby destinations for the new primary database, and manually enable archiving of redo data for each of these destinations.

For example, to enable archiving for the remote destination defined by the LOG\_ARCHIVE\_DEST\_2 parameter, issue the following statement:

```
SQL> ALTER SYSTEM SET LOG_ARCHIVE_DEST_STATE_2=ENABLE SCOPE=BOTH;
```

To ensure that this change persists if the new primary database is later restarted, update the appropriate text initialization parameter file or server parameter file. In general, when the database operates in the primary role, you must enable archiving to remote destinations, and when the database operates in the standby role, you must disable archiving to remote destinations.

4. Issue the following statement on the target logical standby database (that you are transitioning to the new primary role):

```
SQL> ALTER DATABASE ACTIVATE LOGICAL STANDBY DATABASE FINISH APPLY;
```

This statement stops the remote file server (RFS) process, applies remaining redo data in the standby redo log file before the logical standby database becomes a primary database, stops SQL Apply, and activates the database in the primary database role.

If the FINISH APPLY clause is not specified, then unapplied redo from the current standby redo log file is not applied before the standby database becomes the primary database.

5. Follow the method described in [Configuring Logical Standby Databases After a Failover](#) to ensure existing logical standby databases can continue to provide protection for the new primary database.
6. Back up the new primary database immediately after the Oracle Data Guard database failover. Immediately performing a backup is a necessary safety measure, because you cannot recover changes made after the failover without a complete backup copy of the database.
7. After a failover, the original primary database can be converted into a logical standby database of the new primary database using the method described in [Converting a Failed Primary Into a Standby Database Using Flashback Database](#) or [Converting a Failed Primary into a Standby Database Using RMAN Backups](#), or it can be recreated as a logical standby database from a backup of the new primary database as described in [Creating a Logical Standby Database](#).

Once the original primary database has been converted into a standby database, a switchover can be performed to restore it to the primary role.

## 9.4 Using Flashback Database After a Role Transition

After a role transition, you can optionally use the `FLASHBACK DATABASE` command to revert the databases to a point in time or system change number (SCN) prior to when the role transition occurred.

If you flash back a primary database, you must flash back all of its standby databases to either the same (or earlier) SCN or time. When flashing back primary or standby databases in this way, you do not have to be aware of past switchovers. Oracle can automatically flashback across past switchovers if the SCN/time is before any past switchover.

### Note:

Flashback Database must be enabled on the databases before the role transition occurs. See *Oracle Database Backup and Recovery User's Guide* for more information

### 9.4.1 Using Flashback Database After a Switchover

After a switchover, you can return databases to a time or system change number (SCN) prior to when the switchover occurred using the `FLASHBACK DATABASE` command.

If the switchover involved a physical standby database, the primary and standby database roles are preserved during the flashback operation. The role in which the database is running does not change when the database is flashed back to the target SCN or time to which you flashed back the database. A database running in the physical standby role after the switchover but prior to the flashback still runs in the physical standby database role after the Flashback Database operation.

If the switchover involved a logical standby database, flashing back changes the role of the standby database to what it was at the target SCN or time to which you flashed back the database.

### 9.4.2 Using Flashback Database After a Failover

You can use Flashback Database to convert the failed primary database to a point in time before the failover occurred and then convert it into a standby database.

See [Converting a Failed Primary Into a Standby Database Using Flashback Database](#) for the complete step-by-step procedure.



# 10

## Managing Physical and Snapshot Standby Databases

This chapter discusses the various ways that physical and snapshot standby databases need to be managed.

See the following topics:

- [Starting Up and Shutting Down a Physical Standby Database](#)
- [Opening a Physical Standby Database](#)
- [Primary Database Changes That Require Manual Intervention at a Physical Standby](#)
- [Recovering Through the OPEN RESETLOGS Statement](#)
- [Monitoring Primary, Physical Standby, and Snapshot Standby Databases](#)
- [Replicating Restore Points from Primary to Standby](#)
- [Tuning Redo Apply](#)
- [Tuning Databases in an Active Data Guard Environment with SQL Tuning Advisor](#)
- [Using Oracle Diagnostic Pack to Tune Oracle Active Data Guard Standbys](#)
- [Managing a Snapshot Standby Database](#)

See *Oracle Data Guard Broker* to learn how the Oracle Data Guard broker simplifies the management of physical and snapshot standby databases.

### 10.1 Starting Up and Shutting Down a Physical Standby Database

This section describes how to start up and shut down a physical standby database.

#### 10.1.1 Starting Up a Physical Standby Database

Use the SQL\*Plus `STARTUP` command to start a physical standby database.

The SQL\*Plus `STARTUP` command starts, mounts, and opens a physical standby database in read-only mode when it is invoked without any arguments.

After it has been mounted or opened, a physical standby database can receive redo data from the primary database.

See [Applying Redo Data to Physical Standby Databases](#) for information about Redo Apply and [Opening a Physical Standby Database](#) for information about opening a physical standby database in read-only mode.

 **Note:**

When Redo Apply is started on a physical standby database that has not yet received redo data from the primary database, an `ORA-01112` message may be returned. This indicates that Redo Apply is unable to determine the starting sequence number for media recovery. If this occurs, manually retrieve an archived redo log file from the primary database and register it on the standby database, or wait for redo transport to begin before starting Redo Apply.

## 10.1.2 Shutting Down a Physical Standby Database

Use the SQL\*Plus `SHUTDOWN` command to stop Redo Apply and shut down a physical standby database.

Control is not returned to the session that initiates a database shutdown until shutdown is complete.

If the primary database is up and running, defer the standby destination on the primary database and perform a log switch before shutting down the physical standby database.

## 10.2 Opening a Physical Standby Database

A physical standby database can be opened for read-only access and used to offload queries from a primary database.

 **Note:**

A physical standby database that is opened in read-only mode is subject to the same restrictions as any other Oracle database opened in read-only mode. For more information, see *Oracle Database Administrator's Guide*.

If a license for the Oracle Active Data Guard option has been purchased, Redo Apply can be active while the physical standby database is open, thus allowing queries to return results that are identical to what would be returned from the primary database. This capability is known as the real-time query feature. See [Real-time query](#) for more details.

If a license for the Oracle Active Data Guard option has not been purchased, a physical standby database cannot be open while Redo Apply is active, so the following rules must be observed when opening a physical standby database instance or starting Redo Apply:

- Redo Apply must be stopped before any physical standby database instance is opened.
- If one or more physical standby instances are open, those instances must be stopped or restarted in a mounted state before starting Redo Apply.

 **See Also:**

- *Oracle Database Licensing Information* for more information about Oracle Active Data Guard

## 10.2.1 Real-time Query

The `COMPATIBLE` database initialization parameter must be set to 11.0 or higher to use the real-time query feature of the Oracle Active Data Guard option.

A physical standby database instance cannot be opened if Redo Apply is active on a mounted instance of that database. Use the following SQL statements to stop Redo Apply, open a standby instance read-only, and restart Redo Apply:

```
SQL> ALTER DATABASE RECOVER MANAGED STANDBY DATABASE CANCEL;
SQL> ALTER DATABASE OPEN;
SQL> ALTER DATABASE RECOVER MANAGED STANDBY DATABASE DISCONNECT;
```

 **Note:**

If Redo Apply is active on an open instance, additional instances can be opened without having to stop Redo Apply.

Redo Apply cannot be started on a mounted physical standby instance if any instance of that database is open. The instance must be opened before starting Redo Apply on it.

### Example: Querying V\$DATABASE to Check the Standby's Open Mode

This example shows how the value of the `V$DATABASE.OPEN_MODE` column changes when a physical standby is open in real-time query mode.

1. Start up and open a physical standby instance, and perform the following SQL query to show that the database is open in read-only mode:

```
SQL> SELECT open_mode FROM V$DATABASE;
```

```
OPEN_MODE
-----
READ ONLY
```

2. Issue the following SQL statement to start Redo Apply:

```
SQL> ALTER DATABASE RECOVER MANAGED STANDBY DATABASE DISCONNECT;
```

Database altered.

3. Now that the standby is in real-time query mode (the standby is open in read-only mode and Redo Apply is active), the `V$DATABASE.OPEN_MODE` column changes to indicate the following:

```
SQL> SELECT open_mode FROM V$DATABASE;
```

```
OPEN_MODE
```

-----  
READ ONLY WITH APPLY

### 10.2.1.1 Monitoring Apply Lag in a Real-time Query Environment

If you are using real-time query to offload queries from a primary database to a physical standby database, you can monitor the apply lag to ensure that it is within acceptable limits.

The current apply lag is the difference, in elapsed time, between when the last applied change became visible on the standby and when that same change was first visible on the primary. This metric is computed to the nearest second.

To obtain the apply lag, query the V\$DATAGUARD\_STATS view. For example:

```
SQL> SELECT name, value, datum_time, time_computed FROM V$DATAGUARD_STATS -
> WHERE name like 'apply lag';
```

NAME	VALUE	DATUM_TIME	TIME_COMPUTED
-----	-----	-----	-----
apply lag	+00 00:00:00	05/27/2009 08:54:16	05/27/2009 08:54:17

The apply lag metric is computed using data that is periodically received from the primary database. The DATUM\_TIME column contains a timestamp of when this data was last received by the standby database. The TIME\_COMPUTED column contains a timestamp taken when the apply lag metric was calculated. The difference between the values in these columns should be less than 30 seconds. If the difference is larger than this, the apply lag metric may not be accurate.

To obtain a histogram that shows the history of apply lag values since the standby instance was last started, query the V\$STANDBY\_EVENT\_HISTOGRAM view. For example:

```
SQL> SELECT * FROM V$STANDBY_EVENT_HISTOGRAM WHERE NAME = 'apply lag' -
> AND COUNT > 0;
```

NAME	TIME	UNIT	COUNT	LAST_TIME_UPDATED
-----	-----	-----	-----	-----
apply lag	0	seconds	79681	06/18/2009 10:05:00
apply lag	1	seconds	1006	06/18/2009 10:03:56
apply lag	2	seconds	96	06/18/2009 09:51:06
apply lag	3	seconds	4	06/18/2009 04:12:32
apply lag	4	seconds	1	06/17/2009 11:43:51
apply lag	5	seconds	1	06/17/2009 11:43:52

6 rows selected

To evaluate the apply lag over a time period, take a snapshot of V\$STANDBY\_EVENT\_HISTOGRAM at the beginning of the time period and compare that snapshot with one taken at the end of the time period.

### 10.2.1.2 Configuring Apply Lag Tolerance in a Real-time Query Environment

The STANDBY\_MAX\_DATA\_DELAY session parameter can be used to specify a session-specific apply lag tolerance, measured in seconds, for queries issued by non-administrative users to a physical standby database that is in real-time query mode.

This capability allows queries to be safely offloaded from the primary database to a physical standby database, because it is possible to detect if the standby database has become unacceptably stale.

If `STANDBY_MAX_DATA_DELAY` is set to the default value of `NONE`, then queries issued to a physical standby database are executed regardless of the apply lag on that database.

If `STANDBY_MAX_DATA_DELAY` is set to a nonzero value, then queries issued to a physical standby database are executed only if the apply lag is less than or equal to `STANDBY_MAX_DATA_DELAY`. Otherwise, an `ORA-3172` error is returned to alert the client that the apply lag is too large.

If `STANDBY_MAX_DATA_DELAY` is set to 0, a query issued to a physical standby database is guaranteed to return the exact same result as if the query were issued on the primary database, unless the standby database is lagging behind the primary database, in which case an `ORA-3172` error is returned.

Use the `ALTER SESSION SQL` statement to set `STANDBY_MAX_DATA_DELAY`. For example:

```
SQL> ALTER SESSION SET STANDBY_MAX_DATA_DELAY=2
```

### 10.2.1.3 Forcing Redo Apply Synchronization in a Real-time Query Environment

To ensure that all redo data received from the primary database has been applied to a physical standby database, you can use a `SQL ALTER SESSION` statement.

Issue the following `SQL` statement:

```
SQL> ALTER SESSION SYNC WITH PRIMARY;
```

This statement blocks until all redo data received by the standby database at the time that this command is issued has been applied to the physical standby database. An `ORA-3173` error is returned immediately, and synchronization does not occur, if the redo transport status at the standby database is not `SYNCHRONIZED` or if Redo Apply is not active.

To ensure that Redo Apply synchronization occurs in specific cases, use the `SYS_CONTEXT('USERENV', 'DATABASE_ROLE')` function to create a standby-only trigger (enabled on the primary but that only takes certain actions if it is running on a standby). For example, you could create the following trigger that would execute the `ALTER SESSION SYNC WITH PRIMARY` statement for a specific user connection at logon:

```
CREATE TRIGGER adg_logon_sync_trigger
AFTER LOGON ON user.schema
begin
    if (SYS_CONTEXT('USERENV', 'DATABASE_ROLE') IN ('PHYSICAL STANDBY')) then
        execute immediate 'alter session sync with primary';
    end if;
end;
```

### 10.2.1.4 Real-time Query Restrictions

This list discusses restrictions related to real-time query mode.

- The apply lag control and Redo Apply synchronization mechanisms described above require that the client be connected and issuing queries to a physical standby database that is in real-time query mode.
- The following additional restrictions apply if `STANDBY_MAX_DATA_DELAY` is set to 0 or if the `ALTER SESSION SYNC WITH PRIMARY SQL` statement is used:
  - The standby database must receive redo data via the `SYNC` transport.

- The redo transport status at the standby database must be SYNCHRONIZED and the primary database must be running in either maximum protection mode or maximum availability mode.
- Real-time apply must be enabled.
- Oracle Active Data Guard achieves high performance of real-time queries in an Oracle RAC environment through the use of cache fusion. This allows the Oracle Data Guard apply instance and queries to work out of cache and not be slowed down by disk I/O limitations.

A consequence of this is that an unexpected failure of the apply instance leaves buffers in inconsistent states across all the open Oracle RAC instances. If the database is open on any other instances, one of the open instances performs Active Data Guard instance recovery to bring the database to a consistent state and all the open instances remain open.

#### See Also:

- *Oracle Data Guard Broker* for more information about how the broker handles apply instance failures
- The My Oracle Support note 1357597.1 at <http://support.oracle.com> for additional information about apply instance failures in an Oracle Active Data Guard Oracle RAC standby

## 10.2.1.5 Automatic Block Media Recovery

If corrupt data blocks are encountered when a database is accessed, they can be automatically replaced with uncorrupted copies of those blocks.

This requires the following conditions:

- The physical standby database must be operating in real-time query mode, which requires an Oracle Active Data Guard license.
- The physical standby database must be running real-time apply.

Automatic block media recovery works in two directions depending on whether the corrupted blocks are encountered on the primary or on the standby.

### Corrupted Blocks On the Primary

If corrupt data blocks are encountered at a primary database, then the primary automatically searches for good copies of those blocks on a standby and, if they are found, has them shipped back to the primary.

The primary requires a `LOG_ARCHIVE_DEST_n` to the standby only (a physical standby, a cascading physical standby, or a far sync instance). The primary does not require a `LOG_ARCHIVE_DEST_n` to any terminal destinations; it is able to automatically ascertain their service names.

### Corrupted Blocks On a Standby

If corrupt data blocks are encountered at a standby, then the standby automatically initiates communication with the primary and requests uncorrupted copies of those blocks. For the primary to be able to ship the uncorrupted blocks to the standby,

the following database initialization parameters must be configured on the standby. This is true even if the primary does not directly service the standby (for example, in cascading configurations).

- The `LOG_ARCHIVE_CONFIG` parameter is configured with a `DG_CONFIG` list and a `LOG_ARCHIVE_DEST_n` parameter is configured for the primary database.

**or**

- The `FAL_SERVER` parameter is configured and its value contains an Oracle Net service name for the primary database.

#### Additional Automatic Block Media Repair Considerations

- Automatic repair is supported with any Oracle Data Guard protection mode. However, the effectiveness of repairing a corrupt block at the primary using the non-corrupt version of the block from the standby depends on how closely the standby apply is synchronized with the redo generated by the primary.
- When an automatic block repair has been performed, a message is written to the database alert log.
- If automatic block repair is not possible, an `ORA-1578` error is returned.

### 10.2.1.6 Manual Block Media Recovery

The `RMAN RECOVER BLOCK` command is used to manually repair a corrupted data block.

This command searches several locations for an uncorrupted copy of the data block. By default, one of the locations is any available physical standby database operating in real-time query mode. The `EXCLUDE STANDBY` option of the `RMAN RECOVER BLOCK` command can be used to exclude physical standby databases as a source for replacement blocks.

#### See Also:

*Oracle Database Backup and Recovery Reference* for more information about the `RMAN RECOVER BLOCK` command

### 10.2.1.7 Tuning Queries on a Physical Standby Database

Queries on a physical standby database can be tuned for optimal performance.

For details about tuning queries, see the *Active Data Guard Best Practices* technical brief available on the Oracle Maximum Availability Architecture (MAA) home page at:

<http://www.oracle.com/goto/maa>

#### Force Full Database Caching Mode

The use of force full database caching mode can potentially improve performance because queries are executed faster.

The enabling and disabling of force full database caching mode is not recorded in redo, so the status of in-memory caching is not necessarily the same on all members of a Data Guard configuration.

For more information about the Force Full Database In-Memory Caching feature, including guidelines on how and when to enable and disable it, see *Oracle Database Performance Tuning Guide*.

### 10.2.1.8 Adding Temp Files to a Physical Standby

If you are using a standby to offload queries from the primary database, then the standby must be configured with the minimum of one temp tablespace with at least one temporary data file.

If the nature of the workload requires more temp table space than is automatically created when the standby is first created, then you may need to manually add additional space.

To add temporary files to the physical standby database, perform the following tasks:

1. Identify the tablespaces that contain temporary files. Do this by entering the following command on the standby database:

```
SQL> SELECT TABLESPACE_NAME FROM DBA_TABLESPACES
2> WHERE CONTENTS = 'TEMPORARY' ;
```

```
TABLESPACE_NAME
-----
TEMP1
TEMP2
```

2. For each tablespace identified in the previous query, add a new temporary file to the standby database. The following example adds a new temporary file called `TEMP1` with size and reuse characteristics that match the primary database temporary files:

```
SQL> ALTER TABLESPACE TEMP1 ADD TEMPFILE
2> '/arch1/boston/temp01.dbf'
3> SIZE 40M REUSE;
```

## 10.2.2 Using SQL and PL/SQL on Active Data Guard Standbys

Starting with Oracle Database Release 19c, you can perform SQL and PL/SQL operations in Active Data Guard standby databases.

### Related Topics

- [Performing DML Operations on Active Data Guard Standby Databases](#)  
You can run DML operations on Active Data Guard standby databases. This enables you to run read-mostly applications, which occasionally execute DMLs, on the standby database.
- [Running Top-level PL/SQL Operations on Active Data Guard Standby Databases](#)  
Top-level PL/SQL blocks that you run on Active Data Guard standby databases can be redirected to and run on the primary database, if they do not contain bind variables.
- [Automatic Recompliation of Modified PL/SQL Objects](#)  
PL/SQL objects that are run on standby instances can be recompiled, if they are invalid.



### 10.2.2.1 Performing DML Operations on Active Data Guard Standby Databases

You can run DML operations on Active Data Guard standby databases. This enables you to run read-mostly applications, which occasionally execute DMLs, on the standby database.

DML operations on a standby can be transparently redirected to and run on the primary database. This includes DML statements that are part of PL/SQL blocks. The Active Data Guard session waits until the corresponding changes are shipped to and applied to the Active Data Guard standby. Read consistency is maintained during the DML operation and the standby database on which the DML is run can view its uncommitted changes. However, all the other standby database instances can view these changes only after the transaction is committed.

 **Note:**

Avoid running too many DML operations on Active Data Guard standby databases. Because the operations are actually performed on the primary, too many DMLs may impact the performance of the primary.

 **Note:**

DML operations in Oracle XA transactions are not supported on Active Data Guard standby databases.

Automatic redirection of DML operations to the primary can be configured at the system level or the session level. The session level setting overrides the system level setting.

To configure automatic redirection of DML operations for all standby sessions in an Active Data Guard environment:

- Set the `ADG_REDIRECT_DML` initialization parameter to `TRUE`.

To configure automatic redirection of DML operations for the current session, use the following command:

- ```
ALTER SESSION ENABLE ADG_REDIRECT_DML;
```

#### **Example 10-1 Performing DML Operations on a Physical Standby Database**

The physical standby database in an Active Data Guard setup contains a table named `employees`. You can insert rows into this table by running DML on a physical standby database in the Active Data Guard environment.

On the standby database, enable DML redirection for the current session:

```
SQL> ALTER SESSION ENABLE ADG_REDIRECT_DML;
```

Add a row to the `employees` table using the following command:

```
SQL> INSERT INTO employees VALUES (.....);
```

At this point, the changed data is visible only to the standby database on which the command was run. After the insert operation is committed on the primary database, the changes are shipped back and applied to all the standby databases.

## 10.2.2.2 Running Top-level PL/SQL Operations on Active Data Guard Standby Databases

Top-level PL/SQL blocks that you run on Active Data Guard standby databases can be redirected to and run on the primary database, if they do not contain bind variables.

To redirect top-level PL/SQL operations that are run on a standby to the primary, configure automatic redirection using the following command on the standby database:

- `ALTER SESSION ENABLE ADG_REDIRECT_PLSQL;`

You can configure automatic redirection for top-level PL/SQL operations only at the session level.

## 10.2.2.3 Automatic Recompliation of Modified PL/SQL Objects

PL/SQL objects that are run on standby instances can be recompiled, if they are invalid.

PL/SQL objects become invalid when their dependent objects are modified or dropped. Starting with Oracle Database Release 19c, invalidated PL/SQL objects run on a standby database can be automatically recompiled by setting the `ADG_REDIRECT_DML` initialization parameter to `TRUE`. The DDL corresponding to these PL/SQL objects is redirected to and executed on the primary database. The standby session waits until the operation is completed.

### Example 10-2 Automatically Recompiling Modified PL/SQL Objects

On the primary database in an Active DataGuard environment, a procedure named `insert_empl` is created. This procedure is used to update the `employees` table.

```
CREATE OR REPLACE PROCEDURE update_sal (emp_id IN NUMBER,sal IN NUMBER)
AS BEGIN
    UPDATE employees SET salary=sal WHERE employee_id=emp_id);
END;
```

The structure of the `employees` table is subsequently modified using an `ALTER TABLE` command. This invalidates the `update_sal` procedure.

On a standby database in the Active DataGuard environment, you want to use the `update_sal` procedure to update the salary of an employee. Run the following commands on the physical standby:

```
SQL> ALTER SESSION ENABLE ADG_REDIRECT_DML;
SQL> exec update_sal(105,6000);
```

The user running these commands has been granted permission to execute the `update_sal` procedure.

## 10.2.3 Using Temporary Tables on Active Data Guard Instances

You can create both global temporary tables and private temporary tables on an Active Data Guard instance.

A temporary table holds data that exists only for the duration of a transaction or session. Data in a temporary table is private to the session. Each session can only see and modify its own data.

### See Also:

- *Oracle Database Concepts* for descriptions of global temporary tables, private temporary tables, and the differences between them

### 10.2.3.1 Global Temporary Tables on Active Data Guard Instances

DML and DDL operations are allowed on temporary tables on Oracle Active Data Guard instances.

#### DML Operations

When a global temporary table is changed by a DML operation, the change itself does not generate redo because it is only a temporary table. But the undo generated for the change does in turn generate redo. Redo generation on a read-only database (such as an Active Data Guard standby) is not allowed. However, DML operations on global temporary tables are allowed on Oracle Active Data Guard standbys because the temporary undo feature allows the undo for changes to a global temporary table to be stored in the temporary tablespace as opposed to the undo tablespace. And undo stored in the temporary tablespace does not generate redo.

This feature benefits Oracle Data Guard in the following ways:

- Read-mostly reporting applications that use global temporary tables for storing temporary data can be offloaded to an Oracle Active Data Guard instance.
- When temporary undo is enabled on the primary database, undo for changes to a global temporary table are not logged in the redo and thus, the primary database generates less redo. Therefore, the amount of redo that Oracle Data Guard must ship to the standby is also reduced, thereby reducing network bandwidth consumption and storage consumption.

To enable temporary undo on the primary database, use the `TEMP_UNDO_ENABLED` initialization parameter. On an Oracle Active Data Guard standby, temporary undo is always enabled by default so the `TEMP_UNDO_ENABLED` parameter has no effect.

#### Restrictions

- The temporary undo feature requires that the database initialization parameter `COMPATIBLE` be set to 12.0.0 or higher.

- The temporary undo feature on Oracle Active Data Guard instances does not support temporary `BLOBS` or temporary `CLOBs`.
- Distributed transactions on an Oracle Active Data Guard instance are not permitted if they involve changes to local objects. For example, you cannot commit a transaction that modifies a global temporary table on the Oracle Active Data Guard instance and also updates a remote table on another database using a database link. You must commit or roll back any outstanding DML operations to global temporary tables on the Active Data Guard instance before issuing a remote DML operation, or vice versa. This also includes implicit writes to global temporary tables made by operations such as `EXPLAIN PLAN` statements.

 **See Also:**

- *Oracle Database Administrator's Guide* for more information about temporary undo
- *Oracle Database Reference* for more information about the `TEMP_UNDO_ENABLED` initialization parameter

## DDL Operations

Global temporary tables can be created on, and dropped from, Active Data Guard standby databases. The DDL for these operations is transparently redirected to the primary database. The Active Data Guard session then waits until the corresponding changes are shipped and applied to the Active Data Guard standby. The following is an example of creating a global temporary table:

```
SQL> CREATE GLOBAL TEMPORARY TABLE tab2(c1 number, c2 varchar(10)) ON  
COMMIT PRESERVE ROWS;
```

```
Table created.  
SQL>
```

 **Note:**

For the DDL redirection to succeed, managed standby recovery at the Active Data Guard standby database must be started with the real-time apply option and the Active Data Guard standby database must be in sync with the primary database.

 **Note:**

Data definition language (DDL) operations on global temporary tables (for example, `CREATE` and `DROP`) can still be issued from the primary database. DDL changes are visible on the standby when it catches up with the primary database.

### 10.2.3.2 Private Temporary Tables on Active Data Guard Instances

You can create private temporary tables on Oracle Active Data Guard instances even though they are read-only.

The reason private temporary tables can be created in read-only databases is that their metadata is stored in memory, rather than on disk. The lifetime of a private temporary table is only during the session which created it and it gets dropped automatically when the session ends. This functionality allows reporting applications to run on Active Data Guard standby databases.

#### Note:

- *Oracle Database Administrator's Guide* for information about creating private temporary tables

### 10.2.4 IM Column Store in an Active Data Guard Environment

As of Oracle Database 12c Release 2 (12.2.0.1), the Oracle Database In-Memory column store (IM column store) is supported on a standby database in an Active Data Guard (ADG) environment.

A reporting workload executing on an Active Data Guard standby database can use the IM column store. Using the IM column store improves the execution performance of the workload because it can take full advantage of accessing data in a compressed columnar format, in memory. Additionally, it is possible to populate a completely different set of data in the IM column store on the primary and standby databases, effectively doubling the size of the IM column store available to the application. To enable IM column store support with multi-instance redo apply, set the initialization parameter `enable_imc_with_mira` to `TRUE`.

Note the following restrictions:

- In-Memory Expressions are captured based only on the queries executed on the primary database.
- In-Memory Information Lifecycle Management (ILM) policies based on access criteria are triggered based only on access recorded on the primary database.

#### Note:

- In-Memory FastStart is not supported on a standby database in an ADG environment.
- In-Memory Join-Groups are not supported on a standby database in an ADG environment.

#### Related Topics

- *Oracle Database In-Memory Guide*

- [Oracle Database Reference](#)

## 10.2.5 In-Memory External Tables in an Active Data Guard Environment

Oracle Active Data Guard supports In-Memory external tables.

In-Memory external tables, both on a primary and standby database, are loaded in parallel. Queries that are run in an Active Data Guard environment use the In-Memory external table segments with parallel query. Using `INMEMORY` or `NO INMEMORY` results in the In-Memory external table segment on an active standby database being released.

### Note:

Using the `FOR SERVICE` subclause of the `INMEMORY...DISTRIBUTE` clause when populating an `INMEMORY` object in the IM column store is not supported for the primary database, standby database, or both.

### See Also:

*Oracle Database In-Memory Guide*

## 10.2.6 Using Sequences in Oracle Active Data Guard

In an Oracle Active Data Guard environment, sequences created by the primary database with the default `CACHE` and `NOORDER` options can be accessed from standby databases as well.

When a standby database accesses such a sequence for the first time, it requests that the primary database allocate a range of sequence numbers. The range is based on the cache size and other sequence properties specified when the sequence was created. Then the primary database allocates those sequence numbers to the requesting standby database by adjusting the corresponding sequence entry in the data dictionary. When the standby has used all the numbers in the range, it requests another range of numbers.

The primary database ensures that each range request from a standby database gets a range of sequence numbers that do not overlap with the ones previously allocated for both the primary and standby databases. This generates a unique stream of sequence numbers across the entire Oracle Data Guard configuration.

Because the standby's requests for a range of sequences involve a round-trip to the primary, be sure to specify a large enough value for the `CACHE` keyword when you create a sequence to be used on an Oracle Active Data Guard standby. Otherwise, performance could suffer.

Also, be sure the terminal standby has a `LOG_ARCHIVE_DEST_n` parameter defined that points back to the primary.

### Example: Assigning a Range of Sequence Values In a Multi-standby Configuration

This example shows how a range of sequence values can be assigned to a database when it references `NEXTVAL` on the sequence either for the first time or after it uses up all of the previously assigned sequence values. In this example, there are two standby databases.

1. On the primary database, issue the following SQL statements to create a global temporary table named `gtt`, and a sequence named `g` with a cache size of 10:

```
SQL> CREATE GLOBAL TEMPORARY TABLE gtt (a int);
```

```
Table created.
```

```
SQL> CREATE SEQUENCE g CACHE 10;
```

```
Sequence created.
```

2. On the first standby database, issue the following SQL statements:

```
SQL> INSERT INTO gtt VALUES (g.NEXTVAL);
```

```
1 row created.
```

```
SQL> INSERT INTO gtt VALUES (g.NEXTVAL);
```

```
1 row created.
```

```
SQL> SELECT * FROM gtt;
```

```
          A
-----
          1
          2
```

Because the sequence cache size was set to 10 (in Step 1) and because this is the first time the sequence was accessed, the results of the `SELECT` statement show that the first standby database is assigned sequence numbers 1 to 10.

3. On the primary database, issue the following SQL statements:

```
SQL> SELECT g.NEXTVAL FROM dual;
```

```
          NEXTVAL
-----
          11
```

```
SQL> SELECT g.NEXTVAL FROM dual;
```

```
          NEXTVAL
-----
          12
```

The results of the `SELECT` statements show that the primary database is assigned the next range of sequence values, 11-20.

4. On the second standby database, issue the following SQL statements:

```
SQL> INSERT INTO gtt VALUES (g.NEXTVAL);
```

```
1 row created.

SQL> INSERT INTO gtt VALUES (g.NEXTVAL);

1 row created.

SQL> SELECT * FROM gtt;

      A
-----
     21
     22
```

The results of the `SELECT` statement show that the second standby is assigned the next range of sequence values, 21-30.

 **Note:**

Sequences created with the `ORDER` or `NOCACHE` options cannot be accessed on an Oracle Active Data Guard standby.

### 10.2.6.1 Session Sequences

A session sequence is a special type of sequence that is specifically designed to be used with global temporary tables that have session visibility.

Unlike the existing regular sequences (referred to as "global" sequences for the sake of comparison), a session sequence returns a unique range of sequence numbers only within a session, but not across sessions. Another difference is that session sequences are not persistent. If a session goes away, so does the state of the session sequences that were accessed during the session.

Session sequences support most of the sequence properties that are specified when the sequence is defined. However, the `CACHE/NOCACHE` and `ORDER/NOORDER` options are not relevant to session sequences and are ignored.

Session sequences must be created by a read/write database but can be accessed on any read/write or read-only databases (either a regular database temporarily open read-only or a standby database).

#### Creating and Altering Session Sequences

To create a session sequence, issue the following SQL statement:

```
SQL> CREATE SEQUENCE ... SESSION;
```

To alter an existing session sequence to be a regular ("global") sequence, issue the following SQL statement:

```
SQL> ALTER SEQUENCE ... GLOBAL;
```

To alter a regular sequence to be a session sequence, issue the following SQL statement:

```
SQL> ALTER SEQUENCE ... SESSION;
```



### Example: Using Session Sequences

This example shows how session sequence values are unique to each database session.

1. On the primary database, issue the following SQL statements to create a global temporary table named `gtt` and a session sequence named `s`:

```
SQL> CREATE GLOBAL TEMPORARY TABLE gtt (a int);
```

```
Table created.
```

```
SQL> CREATE SEQUENCE s SESSION;
```

```
Sequence created.
```

2. On the standby database, issue the following SQL statements:

```
SQL> INSERT INTO gtt VALUES (s.NEXTVAL);
```

```
1 row created.
```

```
SQL> INSERT INTO gtt VALUES (s.NEXTVAL);
```

```
1 row created.
```

```
SQL> SELECT * FROM gtt;
```

```
          A  
-----  
          1  
          2
```

3. From another session of the same standby database, issue the following SQL statements:

```
SQL> INSERT INTO gtt VALUES (s.NEXTVAL);
```

```
1 row created.
```

```
SQL> INSERT INTO gtt VALUES (s.NEXTVAL);
```

```
1 row created.
```

```
SQL> SELECT * FROM gtt;
```

```
          A  
-----  
          1  
          2
```

The results of the `SELECT` statement show that the sequence values assigned are the same as those assigned for the first session in the previous step. This is because sequence values are unique to each database session.

## 10.3 Primary Database Changes That Require Manual Intervention at a Physical Standby

Most structural changes made to a primary database are automatically propagated through redo data to a physical standby database, but there are some changes that require manual intervention.

The following table lists primary database structural and configuration changes that require manual intervention at a physical standby database.

**Table 10-1 Primary Database Changes That Require Manual Intervention at a Physical Standby**

| Primary Database Change                                                          | Action Required on Physical Standby Database                                                                                                                                                                                                                                                                                                                                                                                                                                                                                                                                                                                                                    |
|----------------------------------------------------------------------------------|-----------------------------------------------------------------------------------------------------------------------------------------------------------------------------------------------------------------------------------------------------------------------------------------------------------------------------------------------------------------------------------------------------------------------------------------------------------------------------------------------------------------------------------------------------------------------------------------------------------------------------------------------------------------|
| <a href="#">Adding a Data File or Creating a Tablespace</a>                      | No action is required if the <code>STANDBY_FILE_MANAGEMENT</code> database initialization parameter is set to <code>AUTO</code> . If this parameter is set to <code>MANUAL</code> , the new data file must be copied to the physical standby database.                                                                                                                                                                                                                                                                                                                                                                                                          |
| <a href="#">Dropping Tablespaces and Deleting Data Files</a>                     | Delete data file from primary and physical standby database after the redo data containing the <code>DROP</code> or <code>DELETE</code> command is applied to the physical standby.                                                                                                                                                                                                                                                                                                                                                                                                                                                                             |
| <a href="#">Using Transportable Tablespaces with a Physical Standby Database</a> | Move tablespace between the primary and the physical standby database.                                                                                                                                                                                                                                                                                                                                                                                                                                                                                                                                                                                          |
| <a href="#">Renaming a Data File in the Primary Database</a>                     | Rename the data file on the physical standby database.                                                                                                                                                                                                                                                                                                                                                                                                                                                                                                                                                                                                          |
| <a href="#">Add or Drop a Redo Log File Group</a>                                | Evaluate the configuration of the redo log and standby redo log on the physical standby database and adjust as necessary.                                                                                                                                                                                                                                                                                                                                                                                                                                                                                                                                       |
| <a href="#">NOLOGGING or Unrecoverable Operations</a>                            | Use the <code>RMAN</code> command <code>RECOVER ... NONLOGGED BLOCK</code> to replace the invalid blocks on the standby with the changed blocks from the primary.                                                                                                                                                                                                                                                                                                                                                                                                                                                                                               |
| <a href="#">Refresh the Password File</a>                                        | As of Oracle Database 12c Release 2 (12.2.0.1), password file changes done on the primary database are automatically propagated to standby databases. The only exception to this is far sync instances. Updated password files must still be manually copied to far sync instances because far sync instances receive redo, but do not apply it. After the password file is up-to-date at the far sync instance, the redo containing the password update at the primary is automatically propagated to any standby databases that are set up to receive redo from that far sync instance. The password file is updated on the standby when the redo is applied. |
| <a href="#">Reset the TDE Master Encryption Key</a>                              | Replace the database encryption wallet on the physical standby database with a fresh copy of the database encryption wallet from the primary database.                                                                                                                                                                                                                                                                                                                                                                                                                                                                                                          |
| <a href="#">Initialization Parameters</a>                                        | Evaluate whether a corresponding change must be made to the initialization parameters on the physical standby database.                                                                                                                                                                                                                                                                                                                                                                                                                                                                                                                                         |

## 10.3.1 Adding a Data File or Creating a Tablespace

The `STANDBY_FILE_MANAGEMENT` database initialization parameter controls whether the addition of a data file to the primary database is automatically propagated to a physical standby databases.

- If the `STANDBY_FILE_MANAGEMENT` database parameter on the physical standby database is set to `AUTO`, any new data files created on the primary database are automatically created on the physical standby database.
- If the `STANDBY_FILE_MANAGEMENT` database parameter on the physical standby database is set to `MANUAL`, a new data file must be manually copied from the primary database to the physical standby databases after it is added to the primary database.

### Note:

On a physical standby for which the Oracle Active Data Guard option has been enabled, you cannot use the manual copy method. Instead, you must execute the following SQL statement on the standby to create an empty data file:

```
SQL> ALTER DATABASE CREATE DATAFILE [filename | filenumber] -  
AS [NEW | new_filename];
```

You must specify which one to rename: the `filename` or the `filenumber`.

Also specify either the new filename or `NEW`. The `NEW` keyword lets Oracle automatically choose a name, if Oracle Managed Files (OMF) is enabled.

If an existing data file from another database is copied to a primary database, it must also be copied to the standby database and the standby control file must be re-created, regardless of the setting of `STANDBY_FILE_MANAGEMENT` parameter.

## 10.3.2 Dropping Tablespaces and Deleting Data Files

When a tablespace is dropped or a data file is deleted from a primary database, the corresponding data file(s) must be deleted from the physical standby database.

The following example shows how to drop a tablespace:

```
SQL> DROP TABLESPACE tbs_4;  
SQL> ALTER SYSTEM SWITCH LOGFILE;
```

To verify that deleted data files are no longer part of the database, query the `V$DATAFILE` view.

Delete the corresponding data file on the standby system after the redo data that contains the previous changes is applied to the standby database. For example:

```
% rm /disk1/oracle/oradata/payroll/s2tbs_4.dbf
```

On the primary database, after ensuring the standby database applied the redo information for the dropped tablespace, you can remove the data file for the tablespace. For example:

```
% rm /disk1/oracle/oradata/payroll/tbs_4.dbf
```

### 10.3.2.1 Using DROP TABLESPACE INCLUDING CONTENTS AND DATAFILES

You can issue the SQL `DROP TABLESPACE INCLUDING CONTENTS AND DATAFILES` statement on the primary database to delete the data files on both the primary and standby databases.

To use this statement, the `STANDBY_FILE_MANAGEMENT` initialization parameter must be set to `AUTO`. For example, to drop the tablespace at the primary site:

```
SQL> DROP TABLESPACE tbs_4 INCLUDING CONTENTS AND DATAFILES;  
SQL> ALTER SYSTEM SWITCH LOGFILE;
```

### 10.3.3 Using Transportable Tablespaces with a Physical Standby Database

You can use the Oracle transportable tablespaces feature to move a subset of an Oracle database and plug it in to another Oracle database, essentially moving tablespaces between the databases.

To move or copy a set of tablespaces into a primary database when a physical standby is being used, perform the following steps:

1. Generate a transportable tablespace set that consists of data files for the set of tablespaces being transported and an export file containing structural information for the set of tablespaces.
2. Transport the tablespace set:
  - a. Copy the data files and the export file to the primary database.
  - b. Copy the data files to the standby database.

The data files must have the same path name on the primary and standby databases unless the `DB_FILE_NAME_CONVERT` database initialization parameter has been configured. If `DB_FILE_NAME_CONVERT` has *not* been configured and the path names of the data files are not the same on the primary and standby databases, issue the `ALTER DATABASE RENAME FILE` statement to rename the data files. Do this after Redo Apply has failed to apply the redo generated by plugging the tablespace into the primary database. The `STANDBY_FILE_MANAGEMENT` initialization parameter must be set to `MANUAL` before renaming the data files, and then reset to the previous value after renaming the data files.

3. Plug in the tablespace.

Invoke the Data Pump utility to plug the set of tablespaces into the primary database. Redo data is generated and applied at the standby site to plug the tablespace into the standby database.

For more information about transportable tablespaces, see *Oracle Database Administrator's Guide*.

## 10.3.4 Renaming a Data File in the Primary Database

When you rename one or more data files in the primary database, the change is not propagated to the standby database. It must be done manually.

To rename the same data files on the standby database, you must manually make the equivalent modifications on the standby database because the modifications are not performed automatically, even if the `STANDBY_FILE_MANAGEMENT` initialization parameter is set to `AUTO`.

The following steps describe how to rename a data file in the primary database and manually propagate the changes to the standby database.

1. To rename the data file in the primary database, take the tablespace offline:

```
SQL> ALTER TABLESPACE tbs_4 OFFLINE;
```

2. Exit from the SQL prompt and issue an operating system command, such as the following UNIX `mv` command, to rename the data file on the primary system:

```
% mv /disk1/oracle/oradata/payroll/tbs_4.dbf  
/disk1/oracle/oradata/payroll/tbs_x.dbf
```

3. Rename the data file in the primary database and bring the tablespace back online:

```
SQL> ALTER TABLESPACE tbs_4 RENAME DATAFILE -  
> '/disk1/oracle/oradata/payroll/tbs_4.dbf' -  
> TO '/disk1/oracle/oradata/payroll/tbs_x.dbf';
```

```
SQL> ALTER TABLESPACE tbs_4 ONLINE;
```

### Note:

An alternative to these first three steps is to use the `ALTER DATABASE MOVE DATAFILE` command to rename a datafile. This command lets you rename a datafile while allowing read/write access to the datafile. Adequate storage area is a prerequisite for moving a datafile because during the execution of the `MOVE DATAFILE` command, the database maintains both the original and the renamed datafiles as two separate files. See [Moving the Location of Online Data Files](#) for more information.

4. Connect to the standby database and stop Redo Apply:

```
SQL> ALTER DATABASE RECOVER MANAGED STANDBY DATABASE CANCEL;
```

5. Shut down the standby database:

```
SQL> SHUTDOWN;
```

6. Rename the data file at the standby site using an operating system command, such as the UNIX `mv` command:

```
% mv /disk1/oracle/oradata/payroll/tbs_4.dbf /disk1/oracle/oradata/payroll/  
tbs_x.dbf
```

7. Start and mount the standby database:

```
SQL> STARTUP MOUNT;
```

8. Rename the data file in the standby control file. To rename a data file, you must set the `STANDBY_FILE_MANAGEMENT` database initialization parameter to `MANUAL`. You can then reset the parameter to its previous value after renaming the data file.

```
SQL> ALTER DATABASE RENAME FILE '/disk1/oracle/oradata/payroll/tbs_4.dbf' -
> TO '/disk1/oracle/oradata/payroll/tbs_x.dbf';
```

9. On the standby database, restart Redo Apply:

```
SQL> ALTER DATABASE RECOVER MANAGED STANDBY DATABASE -
> DISCONNECT FROM SESSION;
```

If you do not rename the corresponding data file at the standby system, and then try to refresh the standby database control file, the standby database attempts to use the renamed data file, but will not find it. Error messages similar to the following are written to the alert log:

```
ORA-00283: recovery session canceled due to errors
ORA-01157: cannot identify/lock datafile 4 - see DBWR trace file
ORA-01110: datafile 4: '/Disk1/oracle/oradata/payroll/tbs_x.dbf'
```

#### Note:

An alternative to steps 4-9 is to use the `ALTER DATABASE MOVE DATAFILE` command to rename a datafile at the standby. See [Moving the Location of Online Data Files](#) for more information.

## 10.3.5 Add or Drop a Redo Log File Group

The configuration of the redo log and standby redo log on a physical standby database should be reevaluated and adjusted as necessary after adding or dropping a log file group on the primary database.

Take the following steps to add or drop a log file group or standby log file group on a physical standby database:

1. Stop Redo Apply.
2. If the `STANDBY_FILE_MANAGEMENT` initialization parameter is set to `AUTO`, change the value to `MANUAL`.
3. Add or drop a log file group.

#### Note:

An online logfile group must always be manually cleared before it can be dropped from a physical standby database. For example:

```
ALTER DATABASE CLEAR LOGFILE GROUP 3;
```

An online logfile group that has a status of `CURRENT` or `CLEARING_CURRENT` cannot be dropped from a physical standby database. An online logfile group that has this status can be dropped after a role transition.

4. Restore the `STANDBY_FILE_MANAGEMENT` initialization parameter and the Redo Apply options to their original states.
5. Restart Redo Apply.

In Oracle RAC environments, keep the following in mind:

- When an online redo log group is added to a primary database, you must manually add an online redo log group to the standby database. It is not done automatically.
- When a new redo thread is added to a primary database, a new redo thread is automatically added to the standby. By default, the new thread is configured with 2 log groups of 100 MB each. This cannot be changed or overridden.
- When a new log group is added to an existing redo thread, a new log group is not automatically added to its existing thread.

### 10.3.6 NOLOGGING or Unrecoverable Operations

When you perform a DML or DDL operation using the `NOLOGGING` or `UNRECOVERABLE` clause, blocks on the standby may be marked as invalid (also known as nonlogged blocks).

See [Precedence of FORCE LOGGING Settings](#) for details about when an operation is actually performed in a nonlogged fashion.

See [Recovering After the NOLOGGING Clause Is Specified](#) for information about recovering after the `NOLOGGING` clause is used.

See the *Oracle Database Administrator's Guide*. for information about specifying `FORCE LOGGING` mode.

### 10.3.7 Refresh the Password File

If the `REMOTE_LOGIN_PASSWORDFILE` database initialization parameter is set to `SHARED` or `EXCLUSIVE`, then the password file on a physical standby database is automatically replaced with a fresh copy from the primary database.

The file is replaced after administrative privileges are granted or revoked, or the password of a user with administrative privileges is changed. The only exception to this is far sync instances. Updated password files must still be manually copied to far sync instances because far sync instances receive redo, but do not apply it. When a password file is manually updated at a far sync instance, the redo containing the same password changes from the primary database is automatically propagated to any standby databases that are set up to receive redo from that far sync instance. The password file is updated on the standby when the redo is applied.

### 10.3.8 Reset the TDE Master Encryption Key

The database encryption wallet on a physical standby database must be replaced with a fresh copy of the database encryption wallet from the primary database whenever the TDE master encryption key is reset on the primary database.

Failure to refresh the database encryption wallet on the physical standby database prevents access to encrypted columns on the physical standby database that are modified after the master encryption key is reset on the primary database.

For online tablespaces and databases, as of Oracle Database 12c Release 2 (12.2.0.1), you can encrypt, decrypt, and re-key both new and existing tablespaces, and existing databases within an Oracle Data Guard environment.

For offline tablespaces and databases, as of Oracle Database 12c Release 2 (12.2.0.1), you can encrypt and decrypt both new and existing tablespaces, and existing databases within an Oracle Data Guard environment.

In online conversion, the encryption, decryption, or re-keying on the standby is automatic after it is performed on the primary. An online encryption, decryption, or re-keying cannot be performed directly on a standby database.

In an offline conversion, the encryption or decryption must be performed manually on both the primary and standby. An offline conversion affects the data files on the particular primary or standby database only. Both the primary and physical standby should be kept at the same state. You can minimize downtime by encrypting (or decrypting) the tablespaces on the standby first, switching over to the primary, and then encrypting (or decrypting) the tablespaces on the primary.



**See Also:**

- *Oracle Database Advanced Security Guide*

## 10.4 Recovering Through the OPEN RESETLOGS Statement

Oracle Data Guard allows recovery on a physical standby database to continue after the primary database has been opened with the `RESETLOGS` option.

When an `ALTER DATABASE OPEN RESETLOGS` statement is issued on the primary database, the incarnation of the database changes, creating a new branch of redo data.

When a physical standby database receives a new branch of redo data, Redo Apply automatically takes the new branch of redo data. For physical standby databases, no manual intervention is required if the standby database did not apply redo data past the new resetlogs SCN (past the start of the new branch of redo data). The following table describes how to resynchronize the standby database with the primary database branch.



| If the standby database. . .                                                                                                                                                        | Then. . .                                                                                    | Perform these steps. . .                                                                                                                                                                                                                                                                                                                                                                                                                             |
|-------------------------------------------------------------------------------------------------------------------------------------------------------------------------------------|----------------------------------------------------------------------------------------------|------------------------------------------------------------------------------------------------------------------------------------------------------------------------------------------------------------------------------------------------------------------------------------------------------------------------------------------------------------------------------------------------------------------------------------------------------|
| Has not applied redo data past the new resetlogs SCN (past the start of the new branch of redo data) and the new redo branch from OPEN RESETLOGS has been registered at the standby | Redo Apply automatically takes the new branch of redo.                                       | <p>No manual intervention is necessary. The managed redo process (MRP) automatically resynchronizes the standby database with the new branch of redo data.</p> <p>Note: To check whether the new redo branch has been registered at the standby, perform the following query at the primary and standby and verify that the results match:</p> <pre>SELECT resetlogs_id, resetlogs_change# FROM V\$DATABASE_INCARNATION WHERE status='CURRENT'</pre> |
| Has applied redo data past the new resetlogs SCN (past the start of the new branch of redo data) and Flashback Database is enabled on the standby database                          | The standby database is recovered <i>in the future</i> of the new branch of redo data.       | <ol style="list-style-type: none"> <li>1. Follow the procedure in <a href="#">Flashing Back a Physical Standby Database to a Specific Point-in-Time</a> to flash back a physical standby database.</li> <li>2. Restart Redo Apply to continue application of redo data onto new reset logs branch.</li> </ol> <p>The managed redo process (MRP) automatically resynchronizes the standby database with the new branch.</p>                           |
| Has applied redo data past the new resetlogs SCN (past the start of the new branch of redo data) and Flashback Database is not enabled on the standby database                      | The primary database has diverged from the standby on the indicated primary database branch. | Re-create the physical standby database following the procedures in <a href="#">Creating a Physical Standby Database</a> .                                                                                                                                                                                                                                                                                                                           |
| Is missing intervening archived redo log files from the new branch of redo data                                                                                                     | The MRP cannot continue until the missing log files are retrieved.                           | Locate and register missing archived redo log files from each branch.                                                                                                                                                                                                                                                                                                                                                                                |
| Is missing archived redo log files from the end of the previous branch of redo data.                                                                                                | The MRP cannot continue until the missing log files are retrieved.                           | Locate and register missing archived redo log files from the previous branch.                                                                                                                                                                                                                                                                                                                                                                        |

See *Oracle Database Backup and Recovery User's Guide* for more information about database incarnations, recovering through an OPEN RESETLOGS operation, and Flashback Database.

## 10.5 Automatic Flashback of a Mounted Standby After a Primary RESETLOGS Operation

A standby database that is in a mounted state can automatically follow the primary database after a RESETLOGS operation on the primary. This simplifies standby management after a RESETLOGS operation on the primary.

When flashback or point-in-time recovery is performed either on a primary database or a PDB in the primary database, the primary database or PDB is moved to a previous point in time and the primary is then opened with the `RESETLOGS` option. A new incarnation of the primary or the PDB in the primary is created. For the standby to automatically follow the primary, the MRP performs the following actions:

- detects the new incarnation
- flashes back the standby or the PDB on the standby to the same point in time as that of the primary or the PDB on the primary
- restarts the standby recovery and moves the standby to the new branch of redo

The flashback operation will succeed only when the standby database has sufficient flashback data.

If you do not want the standby to automatically follow the primary, either keep the standby database in `OPEN` mode or stop the MRP process on the standby.

If the standby database is open in read only mode, the corresponding error messages are recorded in the alert log. When you restart the MRP after closing the physical standby, the recovery process automatically flashes back the standby database and continues to apply the new branch of redo.

#### Related Topics

- [Actions Needed On a Standby After a PDB PITR or PDB Flashback On a Primary](#)  
After you perform a PDB PITR or PDB Flashback on a primary, you can either restore the PDB or flashback the PDB on the standby to let the standby follow the primary.
- [Flashing Back a Physical Standby Database to a Specific Point-in-Time](#)  
These steps describe how to avoid re-creating a physical standby database after you issue the `OPEN RESETLOGS` statement on the primary database.

## 10.6 Monitoring Primary, Physical Standby, and Snapshot Standby Databases

This table summarizes common primary database management actions and where to find information related to these actions.

**Table 10-2 Sources of Information About Common Primary Database Management Actions**

| Primary Database Action                                                                                                    | Primary Site Information                                                                                                                                      | Standby Site Information |
|----------------------------------------------------------------------------------------------------------------------------|---------------------------------------------------------------------------------------------------------------------------------------------------------------|--------------------------|
| Enable or disable a redo thread                                                                                            | <ul style="list-style-type: none"> <li>• Alert log</li> <li>• <code>V\$THREAD</code></li> </ul>                                                               | Alert log                |
| Display database role, protection mode, protection level, switchover status, fast-start failover information, and so forth | <code>V\$DATABASE</code>                                                                                                                                      | <code>V\$DATABASE</code> |
| Add or drop a redo log file group                                                                                          | <ul style="list-style-type: none"> <li>• Alert log</li> <li>• <code>V\$LOG</code></li> <li>• <code>STATUS</code> column of <code>V\$LOGFILE</code></li> </ul> | Alert log                |
| <code>CREATE CONTROLFILE</code>                                                                                            | Alert log                                                                                                                                                     | Alert log                |

**Table 10-2 (Cont.) Sources of Information About Common Primary Database Management Actions**

| Primary Database Action                                      | Primary Site Information                                                                                                                      | Standby Site Information                                                                                                                 |
|--------------------------------------------------------------|-----------------------------------------------------------------------------------------------------------------------------------------------|------------------------------------------------------------------------------------------------------------------------------------------|
| Monitor Redo Apply                                           | <ul style="list-style-type: none"> <li>Alert log</li> <li>V\$ARCHIVE_DEST_STATUS</li> </ul>                                                   | <ul style="list-style-type: none"> <li>Alert log</li> <li>V\$ARCHIVED_LOG</li> <li>V\$LOG_HISTORY</li> <li>V\$MANAGED_STANDBY</li> </ul> |
| Change tablespace status                                     | <ul style="list-style-type: none"> <li>V\$RECOVER_FILE</li> <li>DBA_TABLESPACES</li> <li>Alert log</li> </ul>                                 | <ul style="list-style-type: none"> <li>V\$RECOVER_FILE</li> <li>DBA_TABLESPACES</li> </ul>                                               |
| Add or drop a data file or tablespace                        | <ul style="list-style-type: none"> <li>DBA_DATA_FILES</li> <li>Alert log</li> </ul>                                                           | <ul style="list-style-type: none"> <li>V\$DATAFILE</li> <li>Alert log</li> </ul>                                                         |
| Rename a data file                                           | <ul style="list-style-type: none"> <li>V\$DATAFILE</li> <li>Alert log</li> </ul>                                                              | <ul style="list-style-type: none"> <li>V\$DATAFILE</li> <li>Alert log</li> </ul>                                                         |
| Unlogged or unrecoverable operations                         | <ul style="list-style-type: none"> <li>V\$DATAFILE</li> <li>V\$DATABASE</li> </ul>                                                            | Alert log                                                                                                                                |
| Monitor redo transport                                       | <ul style="list-style-type: none"> <li>V\$ARCHIVE_DEST_STATUS</li> <li>V\$ARCHIVED_LOG</li> <li>V\$ARCHIVE_DEST</li> <li>Alert log</li> </ul> | <ul style="list-style-type: none"> <li>V\$ARCHIVED_LOG</li> <li>Alert log</li> </ul>                                                     |
| Issue OPEN RESETLOGS or CLEAR UNARCHIVED LOGFILES statements | Alert log                                                                                                                                     | Alert log                                                                                                                                |
| Change initialization parameter                              | Alert log                                                                                                                                     | Alert log                                                                                                                                |

## 10.6.1 Using Views to Monitor Primary, Physical, and Snapshot Standby Databases

You can use dynamic performance views to monitor primary, physical standby, and snapshot standby databases.

The following dynamic performance views are discussed:

- [V\\$DATABASE](#)
- [V\\$MANAGED\\_STANDBY](#)
- [V\\$ARCHIVED\\_LOG](#)
- [V\\$LOG\\_HISTORY](#)
- [V\\$DATAGUARD\\_STATUS](#)
- [V\\$ARCHIVE\\_DEST](#)

### See Also:

*Oracle Database Reference* for complete reference information about views

### 10.6.1.1 V\$DATABASE

You can use the V\$DATABASE view to display information about data protection, switchover status, and fast-start failover status.

The following query displays the data protection mode, data protection level, database role, and switchover status for a primary, physical standby or snapshot standby database:

```
SQL> SELECT PROTECTION_MODE, PROTECTION_LEVEL, -
> DATABASE_ROLE ROLE, SWITCHOVER_STATUS -
> FROM V$DATABASE;
```

The following query displays fast-start failover status:

```
SQL> SELECT FS_FAILOVER_STATUS "FSFO STATUS", -
> FS_FAILOVER_CURRENT_TARGET TARGET, -
> FS_FAILOVER_THRESHOLD THRESHOLD, -
> FS_FAILOVER_OBSERVER_PRESENT "OBSERVER PRESENT" -
> FROM V$DATABASE;
```

### 10.6.1.2 V\$DATAGUARD\_PROCESS

The V\$DATAGUARD\_PROCESS view displays one row for each Oracle Data Guard process that is currently running.

The V\$DATAGUARD\_PROCESS view replaces the V\$MANAGED\_STANDBY view which is deprecated as of Oracle Database 12c Release 2 (12.2.0.1) and may be desupported in a future release.

The following is an example query of this view:

```
SQL> SELECT ROLE, THREAD#, SEQUENCE#, ACTION FROM V$DATAGUARD_PROCESS;
```

| ROLE                 | THREAD# | SEQUENCE# | ACTION       |
|----------------------|---------|-----------|--------------|
| RFS ping             | 1       | 9         | IDLE         |
| recovery apply slave | 0       | 0         | IDLE         |
| recovery apply slave | 0       | 0         | IDLE         |
| managed recovery     | 0       | 0         | IDLE         |
| recovery logmerger   | 1       | 9         | APPLYING_LOG |
| RFS archive          | 0       | 0         | IDLE         |
| RFS async            | 1       | 9         | IDLE         |

### 10.6.1.3 V\$MANAGED\_STANDBY

You can use the V\$MANAGED\_STANDBY view to query Redo Apply and redo transport status on a physical standby database.

 **Note:**

This view is deprecated as of Oracle Database 12c Release 2 (12.2.0.1) and may be desupported in a future release. The V\$DATAGUARD\_PROCESS view should be used instead.

The following is a sample query of the V\$MANAGED\_STANDBY view:

```
SQL> SELECT PROCESS, STATUS, THREAD#, SEQUENCE#, -
> BLOCK#, BLOCKS FROM V$MANAGED_STANDBY;
```

| PROCESS | STATUS       | THREAD# | SEQUENCE# | BLOCK# | BLOCKS |
|---------|--------------|---------|-----------|--------|--------|
| RFS     | ATTACHED     | 1       | 947       | 72     | 72     |
| MRP0    | APPLYING_LOG | 1       | 946       | 10     | 72     |

The sample output shows that a remote file server (RFS) process completed archiving a redo log file with a sequence number of 947 and that Redo Apply is actively applying an archived redo log file with a sequence number of 946. Redo Apply is currently recovering block number 10 of the 72-block archived redo log file.

### 10.6.1.4 V\$ARCHIVED\_LOG

You can use the V\$ARCHIVED\_LOG view to query information about archived redo log files that have been received by a physical or snapshot standby database from a primary database.

For example, issue the following query:

```
SQL> SELECT THREAD#, SEQUENCE#, FIRST_CHANGE#, -
> NEXT_CHANGE# FROM V$ARCHIVED_LOG;
```

| THREAD# | SEQUENCE# | FIRST_CHANGE# | NEXT_CHANGE# |
|---------|-----------|---------------|--------------|
| 1       | 945       | 74651         | 74739        |
| 1       | 946       | 74739         | 74772        |
| 1       | 947       | 74772         | 74795        |

The sample output shows that three archived redo log files have been received from the primary database.

### 10.6.1.5 V\$LOG\_HISTORY

You can use the V\$LOG\_HISTORY view to query archived log history information.

For example, issue the following query:

```
SQL> SELECT THREAD#, SEQUENCE#, FIRST_CHANGE#, -
> NEXT_CHANGE# FROM V$LOG_HISTORY;
```

### 10.6.1.6 V\$DATAGUARD\_STATUS

You can use the `V$DATAGUARD_STATUS` view to display messages generated by Oracle Data Guard events that caused a message to be written to the alert log or to a server process trace file.

For example, issue the following query :

```
SQL> SELECT MESSAGE FROM V$DATAGUARD_STATUS;
```

### 10.6.1.7 V\$ARCHIVE\_DEST

You can query the `V$ARCHIVE_DEST` view to show the status of each redo transport destination, and for redo transport destinations that are standby databases, the SCN of the last primary database redo applied at that standby database.

For example, issue the following query:

```
SQL> SELECT DEST_ID, STATUS, APPLIED_SCN FROM V$ARCHIVE_DEST WHERE  
TARGET= 'STANDBY' ;
```

| DEST_ID | STATUS | APPLIED_SCN |
|---------|--------|-------------|
| 2       | VALID  | 439054      |
| 3       | VALID  | 439054      |

## 10.7 Replicating Restore Points from Primary to Standby

Restore points that are created on a primary database are automatically replicated to the standby database. The restore points created on the standby database are called *replicated restore points*. Irrespective of whether a restore point on the primary database is a guaranteed restore point or a normal restore point, the corresponding replicated restore point is always a normal restore point.

Oracle Database automatically replicates restore points from a primary database to the standby database when the following conditions are met:

- `COMPATIBLE` initialization parameter for both the primary database and the standby database is set to 19.0.0 or higher
- primary database is open

A restore point that is created on a primary database when the primary is in mount mode is not replicated. This restriction is because the restore point information is replicated through the redo.

The naming convention for a replicated restore point uses the name of the restore point on the primary database suffixed with `_PRIMARY`. If a replicated restore point with the same name exists on the standby database, then a replicated restore point is not created. For example, when you create a restore point named `PRE_MYTBS` on the primary database, the replicated restore point is named `PRE_MYTBS_PRIMARY`. When you delete a restore point on the primary, the corresponding replicated restore point on the standby is also deleted.

The managed redo process (MRP) manages the creation and maintenance of replicated restore points. If restore points are created on the primary database when

MRP is not running, then these restore points are replicated to the standby database after MRP is started.

To determine if a restore point is automatically replicated, query the `V$RESTORE_POINT` view.

## 10.8 Tuning Redo Apply

Oracle technical briefs are available that describe how to optimize Redo Apply and media recovery performance.

In particular, see *Active Data Guard 11g Best Practices (includes best practices for Redo Apply)*. This paper is available on the Oracle Maximum Availability Architecture (MAA) home page at:

<http://www.oracle.com/goto/maa>

### See Also:

My Oracle Support note 454848.1 at <http://support.oracle.com> for information about the installation and use of the Standby Statspack, which can be used to collect Redo Apply performance data from a physical standby database

## 10.9 Tuning Databases in an Active Data Guard Environment with SQL Tuning Advisor

In an Active Data Guard environment, SQL Tuning Advisor can tune a standby workload on a primary database.

Using database links, you can issue SQL Tuning Advisor statements on one database, but execute the statements on a different database.

### Tuning a Standby Database Workload on a Primary Database

In some cases, a standby database can assume a reporting role in addition to its data protection role. The standby database can have its own workload of queries, some of which may require tuning. In this scenario, you tune a standby database workload by issuing every tuning statement on the standby database, but SQL Tuning Advisor performs its analysis on the primary database by using a standby-to-primary database link.

The following are the tasks that must be performed to tune a standby database workload on a primary database. The tasks must be performed at the standby database in the order given, using the `DBMS_SQLTUNE` PL/SQL package:

1. Execute the `DBMS_SQLTUNE.CREATE_TUNING_TASK` statement to fetch the data from the primary database needed to create a task. Because the standby is a read-only database, the data about the task is written remotely to the primary database. A database link parameter is required in this step to write to the primary. (A database link parameter is optional in subsequent steps, because it is tied to the task created in this step.)

2. Execute the `DBMS_SQLTUNE.EXECUTE_TUNING_TASK` statement. Initially, the data required to execute a task is fetched from the remote primary database. The tuning analysis process to find the possible recommendations is executed. Because the standby is a read-only database, when the results are available they are stored remotely at the primary.
3. Execute the `DBMS_SQLTUNE.REPORT_TUNING_TASK` statement. The data needed to construct a report is stored remotely at the primary database. The data is fetched remotely from the primary and constructed locally at the standby.
4. Execute the `DBMS_SQLTUNE.ACCEPT_SQL_PROFILE` statement. The profile data is written to the remote primary database because the standby is read-only.
5. The SQL Profiles are made available at the standby using Redo Apply.

 **See Also:**

- *Oracle Database PL/SQL Packages and Types Reference* for more information about the `DBMS_SQLTUNE` package
- *Oracle Database SQL Tuning Guide* for more information about local and remote SQL tuning

## 10.10 Using Oracle Diagnostic Pack to Tune Oracle Active Data Guard Standbys

The Oracle Diagnostic Pack can be used with an Oracle Active Data Guard standby database that is open in read-only mode.

This enables you to capture performance data to the Automatic Workload Repository (AWR) for an Oracle Active Data Guard standby and to run Automatic Database Diagnostic Monitor (ADDM) analysis on the AWR data. For details about how to perform these operations, see *Oracle Database Performance Tuning Guide*.

## 10.11 Managing a Snapshot Standby Database

A snapshot standby database is a fully updatable standby database. It receives and archives redo data from a primary database, but does not apply it.

Redo data received from the primary database is applied when a snapshot standby database is converted back into a physical standby database, after discarding all local updates to the snapshot standby database.

A snapshot standby database typically diverges from its primary database over time because redo data from the primary database is not applied as it is received. Local updates to the snapshot standby database cause additional divergence. The data in the primary database is fully protected however, because a snapshot standby can be converted back into a physical standby database at any time, and the redo data received from the primary is then applied.

A snapshot standby database provides disaster recovery and data protection benefits that are similar to those of a physical standby database. Snapshot standby databases are best used in scenarios where the benefit of having a temporary, updatable



snapshot of the primary database justifies increased time to recover from primary database failures.

## 10.11.1 Converting a Physical Standby Database into a Snapshot Standby Database

These steps describe how to convert a physical standby database into a snapshot standby database.

1. Stop Redo Apply, if it is active.
2. Ensure that the database is mounted, but not open.
3. Ensure that a fast recovery area has been configured. It is not necessary for flashback database to be enabled.
4. Issue the following SQL statement to perform the conversion:

```
SQL> ALTER DATABASE CONVERT TO SNAPSHOT STANDBY;
```

5. Open the snapshot standby in read/write mode by issuing the following SQL statement:

```
SQL> ALTER DATABASE OPEN READ WRITE;
```

### Note:

A physical standby database that is managed by the Oracle Data Guard broker can be converted into a snapshot standby database using either DGMGRL or Oracle Enterprise Manager Cloud Control. See *Oracle Data Guard Broker* for more details.

## 10.11.2 Using a Snapshot Standby Database

A snapshot standby database can be opened in read-write mode and is fully updatable.

A snapshot standby database has the following characteristics:

- A snapshot standby database cannot be the target of a switchover or failover. A snapshot standby database must first be converted back into a physical standby database before performing a role transition to it.
- A snapshot standby database cannot be the only standby database in a Maximum Protection Oracle Data Guard configuration.

 **Note:**

Flashback Database is used to convert a snapshot standby database back into a physical standby database. Any operation that cannot be reversed using Flashback Database technology prevents a snapshot standby from being converted back to a physical standby.

For information about some of the limitations of Flashback Database, see *Oracle Database Backup and Recovery User's Guide*.

### 10.11.3 Converting a Snapshot Standby Database into a Physical Standby Database

These steps describe how to convert a snapshot standby database into a physical standby database.

1. On an Oracle Real Applications Cluster (Oracle RAC) database, shut down all but one instance.
2. Ensure that the database is mounted, but not open.
3. Issue the following SQL statement to perform the conversion:

```
SQL> ALTER DATABASE CONVERT TO PHYSICAL STANDBY;
```

Redo data received while the database was a snapshot standby database is automatically applied when Redo Apply is started.

 **Note:**

A snapshot standby database must be opened at least once in read-write mode before it can be converted into a physical standby database.

# 11

## Managing a Logical Standby Database

An understanding of these concepts will help you to successfully manage a logical standby database.

- [Overview of the SQL Apply Architecture](#)
- [Controlling User Access to Tables in a Logical Standby Database](#)
- [Views Related to Managing and Monitoring a Logical Standby Database](#)
- [Monitoring a Logical Standby Database](#)
- [Customizing a Logical Standby Database](#)
- [Managing Specific Workloads In the Context of a Logical Standby Database](#)
- [Tuning a Logical Standby Database](#)
- [Backup and Recovery in the Context of a Logical Standby Database](#)

### 11.1 Overview of the SQL Apply Architecture

SQL Apply uses a collection of background processes to apply changes from the primary database to the logical standby database.

Figure 11-1 shows the flow of information and the role that each process performs.

Figure 11-1 SQL Apply Processing

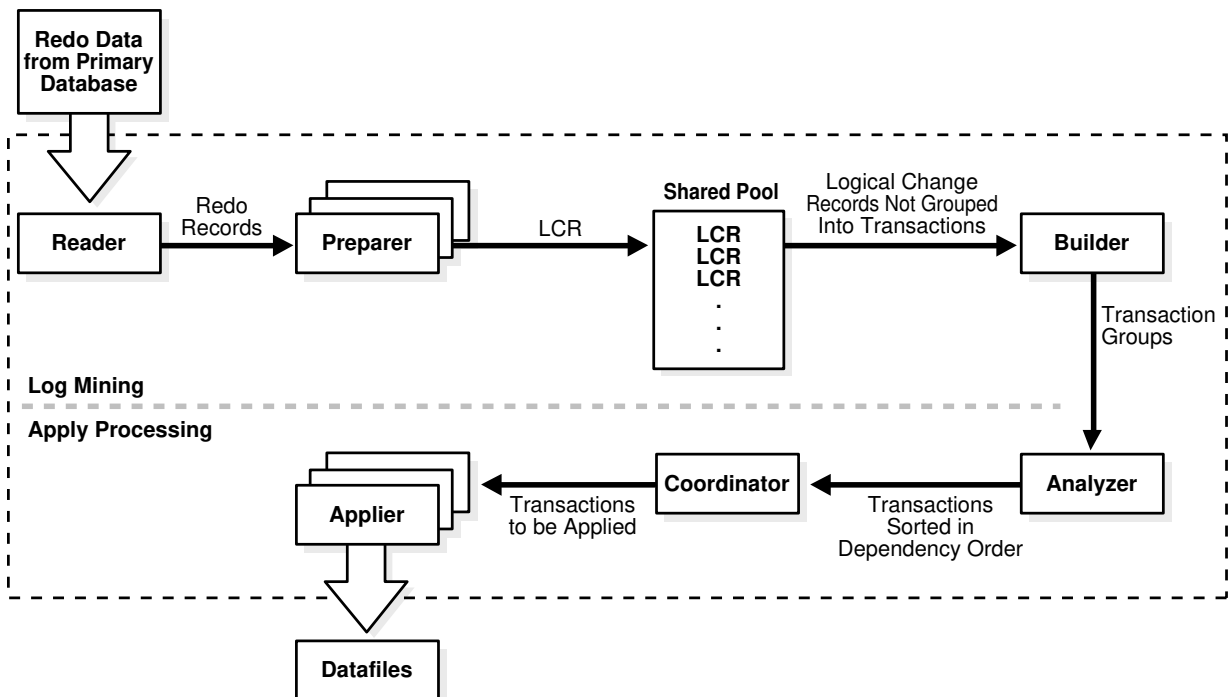

The different processes involved and their functions during log mining and apply processing are as follows:

During log mining:

- The `READER` process reads redo records from the archived redo log files or standby redo log files.
- The `PREPARER` process converts block changes contained in redo records into logical change records (LCRs). Multiple `PREPARER` processes can be active for a given redo log file. The LCRs are staged in the system global area (SGA), known as the *LCR cache*.
- The `BUILDER` process groups LCRs into transactions, and performs other tasks, such as memory management in the LCR cache, checkpointing related to SQL Apply restart and filtering out of uninteresting changes.

During apply processing:

- The `ANALYZER` process identifies dependencies between different transactions.
- The `COORDINATOR` process (LSP) assigns transactions to different appliers and coordinates among them to ensure that dependencies between transactions are honored.
- The `APPLIER` processes applies transactions to the logical standby database under the supervision of the coordinator process.

You can query the `V$LOGSTDBY_PROCESS` view to examine the activity of the SQL Apply processes. Another view that provides information about current activity is the `V$LOGSTDBY_STATS` view that displays statistics, current state, and status information for the logical standby database during SQL Apply activities. These and other relevant views are discussed in more detail in [Views Related to Managing and Monitoring a Logical Standby Database](#).



**Note:**

All SQL Apply processes (including the coordinator process `lsp0`) are true background processes. They are not regulated by resource manager. Therefore, creating resource groups at the logical standby database does not affect the SQL Apply processes.

### 11.1.1 Various Considerations for SQL Apply

Understanding these concepts about transaction size, pageouts, restarts, DML Apply, and password verification will help you to manage logical standbys to their best advantage.

See the following:

- [Transaction Size Considerations](#)
- [Pageout Considerations](#)
- [Restart Considerations](#)
- [DML Apply Considerations](#)

- [DDL Apply Considerations](#)
- [Password Verification Functions](#)

### 11.1.1.1 Transaction Size Considerations

SQL Apply categorizes transactions into two classes: small and large.

Definitions of each class are as follows:

- Small transactions—SQL Apply starts applying LCRs belonging to a small transaction once it has encountered the commit record for the transaction in the redo log files.
- Large transactions—SQL Apply breaks large transactions into smaller pieces called *transaction chunks*, and starts applying the chunks before the commit record for the large transaction is seen in the redo log files. This is done to reduce memory pressure on the LCR cache and to reduce the overall failover time.

For example, without breaking into smaller pieces, a SQL\*Loader load of ten million rows, each 100 bytes in size, would use more than 1 GB of memory in the LCR cache. If the memory allocated to the LCR cache was less than 1 GB, it would result in pageouts from the LCR cache.

Apart from the memory considerations, if SQL Apply did not start applying the changes related to the ten million row SQL\*Loader load until it encountered the COMMIT record for the transaction, it could stall a role transition. A switchover or a failover that is initiated after the transaction commit cannot finish until SQL Apply has applied the transaction on the logical standby database.

Despite the use of transaction chunks, SQL Apply performance may degrade when processing transactions that modify more than eight million rows. For transactions larger than 8 million rows, SQL Apply uses the temporary segment to stage some of the internal metadata required to process the transaction. Be sure to allocate enough space in your temporary segment for SQL Apply to successfully process transactions larger than 8 million rows.

All transactions start out categorized as small transactions. Depending on the amount of memory available for the LCR cache and the amount of memory consumed by LCRs belonging to a transaction, SQL Apply determines when to recategorize a transaction as a large transaction.

### 11.1.1.2 Pageout Considerations

Pageouts occur in the context of SQL Apply when memory in the LCR cache is exhausted and space needs to be released for SQL Apply to make progress.

For example, assume the memory allocated to the LCR cache is 100 MB and SQL Apply encounters an INSERT transaction to a table with a LONG column of size 300 MB. In this case, the log-mining component pages out the first part of the LONG data to read the later part of the column modification. In a well-tuned logical standby database, pageout activities occur occasionally and should not affect the overall throughput of the system.



### See Also:

See [Customizing a Logical Standby Database](#) for more information about how to identify problematic pageouts and perform corrective actions

## 11.1.1.3 Restart Considerations

Modifications made to the logical standby database do not become persistent until the commit record of the transaction is mined from the redo log files and applied to the logical standby database.

Thus, every time SQL Apply is stopped, whether as a result of a user directive or because of a system failure, SQL Apply must go back and mine the earliest uncommitted transaction again.

In cases where a transaction does little work but remains open for a long period of time, restarting SQL Apply from the start could be prohibitively costly because SQL Apply would have to mine a large number of archived redo log files again, just to read the redo data for a few uncommitted transactions. To mitigate this, SQL Apply periodically checkpoints old uncommitted data. The SCN at which the checkpoint is taken is reflected in the `RESTART_SCN` column of `V$LOGSTDBY_PROGRESS` view. Upon restarting, SQL Apply starts mining redo records that are generated at an SCN greater than value shown by the `RESTART_SCN` column. Archived redo log files that are not needed for restart are automatically deleted by SQL Apply.

Certain workloads, such as large DDL transactions, parallel DML statements (PDML), and direct-path loads, prevent the `RESTART_SCN` from advancing for the duration of the workload.

## 11.1.1.4 DML Apply Considerations

SQL Apply has the following characteristics when applying DML transactions that affect the throughput and latency on the logical standby database:

- Batch updates or deletes done on the primary database, where a single statement results in multiple rows being modified, are applied as individual row modifications on the logical standby database. Thus, it is imperative for each maintained table to have a unique index or a primary key. See [Ensure Table Rows in the Primary Database Can Be Uniquely Identified](#) for more information.
- Direct path inserts performed on the primary database are applied using a conventional `INSERT` statement on the logical standby database.
- Parallel DML (PDML) transactions are not executed in parallel on the logical standby database.

## 11.1.1.5 DDL Apply Considerations

SQL Apply has the following characteristics when applying DDL transactions that affect the throughput and latency on the logical standby database:

- DDL transactions are applied serially on the logical standby database. Thus, DDL transactions applied concurrently on the primary database are applied one at a time on the logical standby database.

- CREATE TABLE AS SELECT (CTAS) statements are executed such that the DML activities (that are part of the CTAS statement) are suppressed on the logical standby database. The rows inserted in the newly created table as part of the CTAS statement are mined from the redo log files and applied to the logical standby database using INSERT statements.
- SQL Apply reissues the DDL that was performed at the primary database, and ensures that DMLs that occur within the same transaction on the same object that is the target of the DDL operation are not replicated at the logical standby database. Thus, the following two cases cause the primary and standby sites to diverge from each other:

- The DDL contains a non-literal value that is derived from the state at the primary database. An example of such a DDL is:

```
ALTER TABLE hr.employees ADD (start_date date default sysdate);
```

Because SQL Apply reissues the same DDL at the logical standby, the function `sysdate()` is reevaluated at the logical standby. Thus, the column `start_date` is created with a different default value than at the primary database.

- The DDL fires DML triggers defined on the target table. Since the triggered DMLs occur in the same transaction as the DDL, and operate on the table that is the target of the DDL, these triggered DMLs are not replicated at the logical standby.

For example, assume you create a table as follows:

```
create table HR.TEMP_EMPLOYEES (
emp_id      number primary key,
first_name  varchar2(64),
last_name   varchar2(64),
modify_date timestamp);
```

Assume you then create a trigger on the table such that any time the table is updated the `modify_date` is updated to reflect the time of change:

```
CREATE OR REPLACE TRIGGER TRG_TEST_MOD_DT BEFORE UPDATE ON
HR.TEST_EMPLOYEES
REFERENCING
NEW AS NEW_ROW FOR EACH ROW
BEGIN
:NEW_ROW.MODIFY_DATE:= SYSTIMESTAMP;
END;
/
```

This table is maintained correctly under the usual DML/DDl workload. However if you add a column with the default value to the table, the ADD COLUMN DDL fires this update trigger and changes the `MODIFY_DATE` column of all rows in the table to a new timestamp. These changes to the `MODIFY_DATE` column are not replicated at the logical standby database. Subsequent DMLs to the table stop SQL Apply because the `MODIFY_DATE` column data recorded in the redo stream does not match the data that exists at the logical standby database.

### 11.1.1.6 Password Verification Functions

Password verification functions that check for the complexity of passwords must be created in the `SYS` schema.

Because SQL Apply does not replicate objects created in the `SYS` schema, such verification functions are not replicated to the logical standby database. You must create the password verification function manually at the logical standby database, and associate it with the appropriate profiles.

## 11.2 Controlling User Access to Tables in a Logical Standby Database

The SQL `ALTER DATABASE GUARD` statement controls user access to tables in a logical standby database.

The database guard is set to `ALL` by default on a logical standby database.

The `ALTER DATABASE GUARD` statement allows the following keywords:

- `ALL`  
Specify `ALL` to prevent all users, other than `SYS`, from making changes to any data in the logical standby database.
- `STANDBY`  
Specify `STANDBY` to prevent all users, other than `SYS`, from making DML and DDL changes to any table or sequence being maintained through SQL Apply.
- `NONE`  
Specify `NONE` to use typical security for all data in the database.

For example, use the following statement to enable users to modify tables not maintained by SQL Apply:

```
SQL> ALTER DATABASE GUARD STANDBY;
```

Privileged users can temporarily turn the database guard off and on for the current session using the `ALTER SESSION DISABLE GUARD` and `ALTER SESSION ENABLE GUARD` statements, respectively. This statement replaces the `DEMS_LOGSTDBY.GUARD_BYPASS` PL/SQL procedure that performed the same function in Oracle9i. The `ALTER SESSION [ENABLE|DISABLE] GUARD` statement is useful when you want to temporarily disable the database guard to make changes to the database, as described in [Modifying a Logical Standby Database](#).



#### Note:

Do not let the primary and logical standby databases diverge while the database guard is disabled.



## 11.3 Views Related to Managing and Monitoring a Logical Standby Database

You can use performance views to monitor the behavior of SQL Apply maintaining a logical standby database.

The following topics describe the key views that can be used to monitor a logical standby database:

- [DBA\\_LOGSTDBY\\_EVENTS View](#)
- [DBA\\_LOGSTDBY\\_LOG View](#)
- [V\\$DATAGUARD\\_STATS View](#)
- [V\\$LOGSTDBY\\_PROCESS View](#)
- [V\\$LOGSTDBY\\_PROGRESS View](#)
- [V\\$LOGSTDBY\\_STATE View](#)
- [V\\$LOGSTDBY\\_STATS View](#)

### See Also:

Oracle Database Reference for complete reference information about views

### 11.3.1 DBA\_LOGSTDBY\_EVENTS View

The `DBA_LOGSTDBY_EVENTS` view records interesting events that occurred during the operation of SQL Apply.

By default, the view records the most recent 10,000 events. However, you can change the number of recorded events by calling `DBMS_LOGSTDBY.APPLY_SET()` PL/SQL procedure. If SQL Apply stops unexpectedly, the reason for the problem is also recorded in this view.

### Note:

Errors that cause SQL Apply to stop are recorded in the events table. These events are put into the `ALERT.LOG` file as well, with the `LOGSTDBY` keyword included in the text. When querying the view, select the columns in order by `EVENT_TIME_STAMP`, `COMMIT_SCN`, and `CURRENT_SCN` to ensure the desired ordering of events.

The view can be customized to contain other information, such as which DDL transactions were applied and which were skipped. For example:

```
SQL> ALTER SESSION SET NLS_DATE_FORMAT = 'DD-MON-YY HH24:MI:SS';
Session altered.
SQL> COLUMN STATUS FORMAT A60
```

```
SQL> SELECT EVENT_TIME, STATUS, EVENT FROM DBA_LOGSTDBY_EVENTS -
> ORDER BY EVENT_TIMESTAMP, COMMIT_SCN, CURRENT_SCN;
```

```
EVENT_TIME          STATUS
-----
EVENT
-----
23-JUL-02 18:20:12 ORA-16111: log mining and apply setting up
23-JUL-02 18:25:12 ORA-16128: User initiated shut down successfully completed
23-JUL-02 18:27:12 ORA-16112: log mining and apply stopping
23-JUL-02 18:55:12 ORA-16128: User initiated shut down successfully completed
23-JUL-02 18:57:09 ORA-16111: log mining and apply setting up
23-JUL-02 20:21:47 ORA-16204: DDL successfully applied
create table hr.test_emp (empno number, ename varchar2(64))
23-JUL-02 20:22:55 ORA-16205: DDL skipped due to skip setting
create database link link_to_boston connect to system identified by
change_on_inst
7 rows selected.
```

This query shows that SQL Apply was started and stopped a few times. It also shows what DDL was applied and skipped.

### 11.3.2 DBA\_LOGSTDBY\_LOG View

The `DBA_LOGSTDBY_LOG` view provides dynamic information about archived logs being processed by SQL Apply.

For example:

```
SQL> COLUMN DICT_BEGIN FORMAT A10;
SQL> SET NUMF 99999999;
SQL> SELECT FILE_NAME, SEQUENCE# AS SEQ#, FIRST_CHANGE# AS F_SCN#, -
> NEXT_CHANGE# AS N_SCN#, TIMESTAMP, -
> DICT_BEGIN AS BEG, DICT_END AS END, -
> THREAD# AS THR#, APPLIED FROM DBA_LOGSTDBY_LOG -
> ORDER BY SEQUENCE#;
```

| FILE_NAME                 | SEQ# | F_SCN  | N_SCN  | TIMESTAM | BEG | END | THR# | APPLIED |
|---------------------------|------|--------|--------|----------|-----|-----|------|---------|
| /oracle/dbs/hq_nyc_2.log  | 2    | 101579 | 101588 | 11:02:58 | NO  | NO  | 1    | YES     |
| /oracle/dbs/hq_nyc_3.log  | 3    | 101588 | 142065 | 11:02:02 | NO  | NO  | 1    | YES     |
| /oracle/dbs/hq_nyc_4.log  | 4    | 142065 | 142307 | 11:02:10 | NO  | NO  | 1    | YES     |
| /oracle/dbs/hq_nyc_5.log  | 5    | 142307 | 142739 | 11:02:48 | YES | YES | 1    | YES     |
| /oracle/dbs/hq_nyc_6.log  | 6    | 142739 | 143973 | 12:02:10 | NO  | NO  | 1    | YES     |
| /oracle/dbs/hq_nyc_7.log  | 7    | 143973 | 144042 | 01:02:11 | NO  | NO  | 1    | YES     |
| /oracle/dbs/hq_nyc_8.log  | 8    | 144042 | 144051 | 01:02:01 | NO  | NO  | 1    | YES     |
| /oracle/dbs/hq_nyc_9.log  | 9    | 144051 | 144054 | 01:02:16 | NO  | NO  | 1    | YES     |
| /oracle/dbs/hq_nyc_10.log | 10   | 144054 | 144057 | 01:02:21 | NO  | NO  | 1    | YES     |
| /oracle/dbs/hq_nyc_11.log | 11   | 144057 | 144060 | 01:02:26 | NO  | NO  | 1    | CURRENT |
| /oracle/dbs/hq_nyc_12.log | 12   | 144060 | 144089 | 01:02:30 | NO  | NO  | 1    | CURRENT |
| /oracle/dbs/hq_nyc_13.log | 13   | 144089 | 144147 | 01:02:41 | NO  | NO  | 1    | NO      |

The YES entries in the BEG and END columns indicate that a LogMiner dictionary build starts at log file sequence number 5. The most recent archived redo log file is sequence number 13, and it was received at the logical standby database at 01:02:41. The APPLIED column indicates that SQL Apply has applied all redo before SCN 144057. Since transactions can span multiple archived log files, multiple archived log files may show the value CURRENT in the APPLIED column.

### 11.3.3 V\$DATAGUARD\_STATS View

The V\$DATAGUARD\_STATS view provides information related to the failover characteristics of the logical standby database.

The information includes the following:

- The time to failover (apply finish time)  
The apply finish time is an estimate of the time required to apply all the received, but unapplied, redo. The estimate is based on the assumption that redo can be applied at the maximum apply rate. The actual time taken to apply all remaining redo depends on the type of redo and the rate at which redo is applied.
- How current is the committed data in the logical standby database (apply lag)
- What the potential data loss will be in the event of a disaster (transport lag).

#### Example 11-1 V\$DATAGUARD\_STATS Contents for a Logical Standby Database

The following output is from a logical standby database that has received and applied all redo generated from the primary database.

```
SQL> COL NAME FORMAT A20
SQL> COL VALUE FORMAT A12
SQL> COL UNIT FORMAT A30
SQL> SELECT NAME, VALUE, UNIT FROM V$DATAGUARD_STATS;
```

| NAME              | VALUE        | UNIT                         |
|-------------------|--------------|------------------------------|
| apply finish time | +00 00:00:00 | day(2) to second(1) interval |
| apply lag         | +00 00:00:00 | day(2) to second(0) interval |
| transport lag     | +00 00:00:00 | day(2) to second(0) interval |

### 11.3.4 V\$LOGSTDBY\_PROCESS View

This view provides information about the current state of the various processes involved with SQL Apply, including;

- Identifying information (sid | serial# | spid)
- SQL Apply process: COORDINATOR, READER, BUILDER, PREPARER, ANALYZER, or APPLIER (type)
- Status of the process's current activity (status\_code | status)
- Highest redo record processed by this process (high\_scn)

For example:

```
SQL> COLUMN SERIAL# FORMAT 9999
SQL> COLUMN SID FORMAT 9999
SQL> SELECT SID, SERIAL#, SPID, TYPE, HIGH_SCN FROM V$LOGSTDBY_PROCESS;
```

| SID | SERIAL# | SPID  | TYPE        | HIGH_SCN   |
|-----|---------|-------|-------------|------------|
| 48  | 6       | 11074 | COORDINATOR | 7178242899 |
| 56  | 56      | 10858 | READER      | 7178243497 |
| 46  | 1       | 10860 | BUILDER     | 7178242901 |

|    |   |       |          |            |
|----|---|-------|----------|------------|
| 45 | 1 | 10862 | PREPARER | 7178243295 |
| 37 | 1 | 10864 | ANALYZER | 7178242900 |
| 36 | 1 | 10866 | APPLIER  | 7178239467 |
| 35 | 3 | 10868 | APPLIER  | 7178239463 |
| 34 | 7 | 10870 | APPLIER  | 7178239461 |
| 33 | 1 | 10872 | APPLIER  | 7178239472 |

9 rows selected.

The `HIGH_SCN` column shows that the reader process is ahead of all other processes, and the `PREPARER` and `BUILDER` process ahead of the rest.

```
SQL> COLUMN STATUS FORMAT A40
SQL> SELECT TYPE, STATUS_CODE, STATUS FROM V$LOGSTDBY_PROCESS;
```

| TYPE        | STATUS_CODE | STATUS                                                                        |
|-------------|-------------|-------------------------------------------------------------------------------|
| COORDINATOR | 16117       | ORA-16117: processing                                                         |
| READER      | 16127       | ORA-16127: stalled waiting for additional transactions to be applied          |
| BUILDER     | 16116       | ORA-16116: no work available                                                  |
| PREPARER    | 16116       | ORA-16117: processing                                                         |
| ANALYZER    | 16120       | ORA-16120: dependencies being computed for transaction at SCN 0x0001.abdb440a |
| APPLIER     | 16124       | ORA-16124: transaction 1 13 1427 is waiting on another transaction            |
| APPLIER     | 16121       | ORA-16121: applying transaction with commit SCN 0x0001.abdb4390               |
| APPLIER     | 16123       | ORA-16123: transaction 1 23 1231 is waiting for commit approval               |
| APPLIER     | 16116       | ORA-16116: no work available                                                  |

The output shows a snapshot of SQL Apply running. On the mining side, the `READER` process is waiting for additional memory to become available before it can read more, the `PREPARER` process is processing redo records, and the `BUILDER` process has no work available. On the apply side, the `COORDINATOR` is assigning more transactions to `APPLIER` processes, the `ANALYZER` is computing dependencies at SCN 7178241034, one `APPLIER` has no work available, while two have outstanding dependencies that are not yet satisfied.



#### See Also:

[Monitoring SQL Apply Progress](#) for example output

## 11.3.5 V\$LOGSTDBY\_PROGRESS View

This view provides detailed information regarding progress made by SQL Apply, including:

- SCN and time at which all transactions that have been committed on the primary database have been applied to the logical standby database (`applied_scn`, `applied_time`)
- SCN and time at which SQL Apply would begin reading redo records (`restart_scn`, `restart_time`) on restart

- SCN and time of the latest redo record received on the logical standby database (latest\_scn, latest\_time)
- SCN and time of the latest record processed by the BUILDER process (mining\_scn, mining\_time)

For example:

```
SQL> SELECT APPLIED_SCN, LATEST_SCN, MINING_SCN, RESTART_SCN -
> FROM V$LOGSTDBY_PROGRESS;
```

```
APPLIED_SCN  LATEST_SCN  MINING_SCN  RESTART_SCN
-----
7178240496   7178240507  7178240507  7178219805
```

According to the output:

- SQL Apply has applied all transactions committed on or before SCN of 7178240496
- The latest redo record received at the logical standby database was generated at SCN 7178240507
- The mining component has processed all redo records generate on or before SCN 7178240507
- If SQL Apply stops and restarts for any reason, it will start mining redo records generated on or after SCN 7178219805

```
SQL> ALTER SESSION SET NLS_DATE_FORMAT='yy-mm-dd hh24:mi:ss';
Session altered
```

```
SQL> SELECT APPLIED_TIME, LATEST_TIME, MINING_TIME, RESTART_TIME -
> FROM V$LOGSTDBY_PROGRESS;
```

```
APPLIED_TIME      LATEST_TIME      MINING_TIME      RESTART_TIME
-----
05-05-12 10:38:21 05-05-12 10:41:53 05-05-12 10:41:21 05-05-12 10:09:30
```

According to the output:

- SQL Apply has applied all transactions committed on or before the time 05-05-12 10:38:21 (APPLIED\_TIME)
- The last redo was generated at time 05-05-12 10:41:53 at the primary database (LATEST\_TIME)
- The mining engine has processed all redo records generated on or before 05-05-12 10:41:21 (MINING\_TIME)
- In the event of a restart, SQL Apply will start mining redo records generated after the time 05-05-12 10:09:30



**See Also:**

[Monitoring SQL Apply Progress](#) for example output

## 11.3.6 V\$LOGSTDBY\_STATE View

This view provides a synopsis of the current state of SQL Apply, including:

- The DBID of the primary database (`primary_dbid`).
- The LogMiner session ID allocated to SQL Apply (`session_id`).
- Whether or not SQL Apply is applying in real time (`realtime_apply`).

For example:

```
SQL> COLUMN REALTIME_APPLY FORMAT a15
SQL> COLUMN STATE FORMAT a16
SQL> SELECT * FROM V$LOGSTDBY_STATE;
```

| PRIMARY_DBID | SESSION_ID | REALTIME_APPLY | STATE    |
|--------------|------------|----------------|----------|
| 1562626987   | 1          | Y              | APPLYING |

The output shows that SQL Apply is running in the real-time apply mode and is currently applying redo data received from the primary database, the primary database's DBID is 1562626987 and the LogMiner session identifier associated the SQL Apply session is 1.



### See Also:

[Monitoring SQL Apply Progress](#) for example output

## 11.3.7 V\$LOGSTDBY\_STATS View

The `V$LOGSTDBY_STATS` view displays statistics, current state, and status information related to SQL Apply. No rows are returned from this view when SQL Apply is not running. This view is only meaningful in the context of a logical standby database.

For example:

```
SQL> ALTER SESSION SET NLS_DATE_FORMAT='dd-mm-yyyy hh24:mi:ss';
Session altered
```

```
SQL> SELECT SUBSTR(name, 1, 40) AS NAME, SUBSTR(value,1,32) AS VALUE FROM V$LOGSTDBY_STATS;
```

| NAME                           | VALUE |
|--------------------------------|-------|
| logminer session id            | 1     |
| number of preparers            | 1     |
| number of appliers             | 5     |
| server processes in use        | 9     |
| maximum SGA for LCR cache (MB) | 30    |
| maximum events recorded        | 10000 |
| preserve commit order          | TRUE  |
| transaction consistency        | FULL  |
| record skipped errors          | Y     |
| record skipped DDLs            | Y     |
| record applied DDLs            | N     |
| record unsupported operations  | N     |

```
realtime apply                Y
apply delay (minutes)        0
coordinator state            APPLYING
coordinator startup time     19-06-2007 09:55:47
coordinator uptime (seconds) 3593
txns received from logminer  56
txns assigned to apply       23
txns applied                 22
txns discarded during restart 33
large txns waiting to be assigned 2
rolled back txns mined       4
DDL txns mined               40
CTAS txns mined              0
bytes of redo mined          60164040
bytes paged out              0
pageout time (seconds)       0
bytes checkpointed           4845
checkpoint time (seconds)    0
system idle time (seconds)   2921
standby redo logs mined      0
archived logs mined          5
gap fetched logs mined       0
standby redo log reuse detected 1
logfile open failures        0
current logfile wait (seconds) 0
total logfile wait (seconds) 2910
thread enable mined          0
thread disable mined         0
```

```
.
40 rows selected.
```

## 11.4 Monitoring a Logical Standby Database

When working with logical standby databases, you can monitor SQL Apply progress, and also the automatic deletion of log files.

See the following topics:

- [Monitoring SQL Apply Progress](#)
- [Automatic Deletion of Log Files](#)

### 11.4.1 Monitoring SQL Apply Progress

SQL Apply can be in any of six states of progress: initializing SQL Apply, waiting for dictionary logs, loading the LogMiner dictionary, applying (redo data), waiting for an archive gap to be resolved, and idle.

[Figure 11-2](#) shows the flow of these states.

**Figure 11-2 Progress States During SQL Apply Processing**

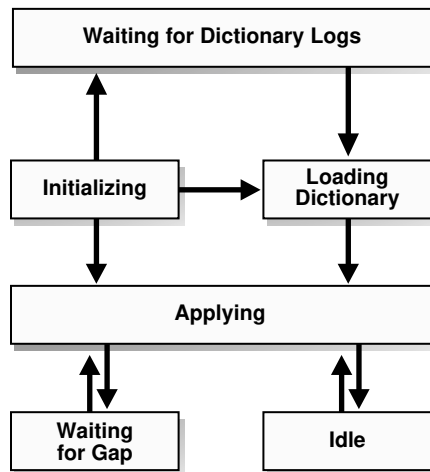

The following subsections describe each state in more detail.

### Initializing State

When you start SQL Apply by issuing an `ALTER DATABASE START LOGICAL STANDBY APPLY` statement, it goes into the *initializing* state.

To determine the current state of SQL Apply, query the `V$LOGSTDBY_STATE` view. For example:

```
SQL> SELECT SESSION_ID, STATE FROM V$LOGSTDBY_STATE;

SESSION_ID   STATE
-----
1            INITIALIZING
```

The `SESSION_ID` column identifies the persistent LogMiner session created by SQL Apply to mine the archived redo log files generated by the primary database.

### Waiting for Dictionary Logs

The first time the SQL Apply is started, it needs to load the LogMiner dictionary captured in the redo log files. SQL Apply stays in the `WAITING FOR DICTIONARY LOGS` state until it has received all redo data required to load the LogMiner dictionary.

### Loading Dictionary State

This *loading dictionary* state can persist for a while. Loading the LogMiner dictionary on a large database can take a long time. Querying the `V$LOGSTDBY_STATE` view returns the following output when loading the dictionary:

```
SQL> SELECT SESSION_ID, STATE FROM V$LOGSTDBY_STATE;

SESSION_ID   STATE
-----
1            LOADING DICTIONARY
```



Only the COORDINATOR process and the mining processes are spawned until the LogMiner dictionary is fully loaded. Therefore, if you query the V\$LOGSTDBY\_PROCESS at this point, you do not see any of the APPLIER processes. For example:

```
SQL> SELECT SID, SERIAL#, SPID, TYPE FROM V$LOGSTDBY_PROCESS;
```

| SID | SERIAL# | SPID  | TYPE        |
|-----|---------|-------|-------------|
| 47  | 3       | 11438 | COORDINATOR |
| 50  | 7       | 11334 | READER      |
| 45  | 1       | 11336 | BUILDER     |
| 44  | 2       | 11338 | PREPARER    |
| 43  | 2       | 11340 | PREPARER    |

You can get more detailed information about the progress in loading the dictionary by querying the V\$LOGMNR\_DICTIONARY\_LOAD view. The dictionary load happens in three phases:

1. The relevant archived redo log files or standby redo logs files are mined to gather the redo changes relevant to load the LogMiner dictionary.
2. The changes are processed and loaded in staging tables inside the database.
3. The LogMiner dictionary tables are loaded by issuing a series of DDL statements.

For example:

```
SQL> SELECT PERCENT_DONE, COMMAND -
> FROM V$LOGMNR_DICTIONARY_LOAD -
> WHERE SESSION_ID = (SELECT SESSION_ID FROM V$LOGSTDBY_STATE);
```

| PERCENT_DONE | COMMAND                                                                                                                          |
|--------------|----------------------------------------------------------------------------------------------------------------------------------|
| 40           | alter table SYSTEM.LOGMNR_CCOL\$ exchange partition P101 with table SYS.LOGMNRLT_101_CCOL\$ excluding indexes without validation |

If the PERCENT\_DONE or the COMMAND column does not change for a long time, query the V\$SESSION\_LONGOPS view to monitor the progress of the DDL transaction in question.

### Applying State

In this state, SQL Apply has successfully loaded the initial snapshot of the LogMiner dictionary, and is currently applying redo data to the logical standby database.

For detailed information about the SQL Apply progress, query the V\$LOGSTDBY\_PROGRESS view:

```
SQL> ALTER SESSION SET NLS_DATE_FORMAT = 'DD-MON-YYYY HH24:MI:SS';
SQL> SELECT APPLIED_TIME, APPLIED_SCN, MINING_TIME, MINING_SCN -
> FROM V$LOGSTDBY_PROGRESS;
```

| APPLIED_TIME         | APPLIED_SCN | MINING_TIME          | MINING_SCN |
|----------------------|-------------|----------------------|------------|
| 10-JAN-2005 12:00:05 | 346791023   | 10-JAN-2005 12:10:05 | 3468810134 |

All committed transactions seen at or before APPLIED\_SCN (or APPLIED\_TIME) on the primary database have been applied to the logical standby database. The mining engine has processed all redo records generated at or before MINING\_SCN (and MINING\_TIME) on the primary database. At steady state, the value of MINING\_SCN (and MINING\_TIME) is always ahead of APPLIED\_SCN (and APPLIED\_TIME).

### Waiting On Gap State

This state occurs when SQL Apply has mined and applied all available redo records, and is waiting for a new log file (or a missing log file) to be archived by the RFS process.

```
SQL> SELECT STATUS FROM V$LOGSTDBY_PROCESS WHERE TYPE = 'READER';
```

```
STATUS
```

```
-----  
ORA-16240: waiting for log file (thread# 1, sequence# 99)
```

### Idle State

SQL Apply enters this state once it has applied all redo generated by the primary database.

## 11.4.2 Automatic Deletion of Log Files

Foreign archived logs contain redo that was shipped from the primary database.

There are two ways to store foreign archive logs:

- In the fast recovery area
- In a directory outside of the fast recovery area

Foreign archived logs stored in the fast recovery area are always managed by SQL Apply. After all redo records contained in the log have been applied at the logical standby database, they are retained for the time period specified by the `DB_FLASHBACK_RETENTION_TARGET` parameter (or for 1440 minutes if `DB_FLASHBACK_RETENTION_TARGET` is not specified). You cannot override automatic management of foreign archived logs that are stored in the fast recovery area.

Foreign archived logs that are not stored in fast recovery area are by default managed by SQL Apply. Under automatic management, foreign archived logs that are not stored in the fast recovery area are retained for the time period specified by the `LOG_AUTO_DEL_RETENTION_TARGET` parameter once all redo records contained in the log have been applied at the logical standby database. You can override automatic management of foreign archived logs not stored in fast recovery area by executing the following PL/SQL procedure:

```
SQL> EXECUTE DBMS_LOGSTDBY.APPLY_SET('LOG_AUTO_DELETE', 'FALSE');
```



#### Note:

Use the `DBMS_LOGSTDBY.APPLY_SET` procedure to set this parameter. If you do not specify `LOG_AUTO_DEL_RETENTION_TARGET` explicitly, it defaults to `DB_FLASHBACK_RETENTION_TARGET` set in the logical standby database, or to 1440 minutes in case `DB_FLASHBACK_RETENTION_TARGET` is not set.

If you are overriding the default automatic log deletion capability, periodically perform the following steps to identify and delete archived redo log files that are no longer needed by SQL Apply:

1. To purge the logical standby session of metadata that is no longer needed, enter the following PL/SQL statement:

```
SQL> EXECUTE DBMS_LOGSTDBY.PURGE_SESSION;
```

This statement also updates the `DBA_LOGMNR_PURGED_LOG` view that displays the archived redo log files that are no longer needed.

2. Query the `DBA_LOGMNR_PURGED_LOG` view to list the archived redo log files that can be removed:

```
SQL> SELECT * FROM DBA_LOGMNR_PURGED_LOG;
```

```
FILE_NAME
-----
/boston/arc_dest/arc_1_40_509538672.log
/boston/arc_dest/arc_1_41_509538672.log
/boston/arc_dest/arc_1_42_509538672.log
/boston/arc_dest/arc_1_43_509538672.log
/boston/arc_dest/arc_1_44_509538672.log
/boston/arc_dest/arc_1_45_509538672.log
/boston/arc_dest/arc_1_46_509538672.log
/boston/arc_dest/arc_1_47_509538672.log
```

3. Use an operating system-specific command to delete the archived redo log files listed by the query.

## 11.5 Customizing a Logical Standby Database

A logical standby database can be customized in several ways, including logging of events, preventing changes to specific schema objects, and adding or re-creating tables.

See the following topics:

- [Customizing Logging of Events in the `DBA\_LOGSTDBY\_EVENTS` View](#)
- [Using `DBMS\_LOGSTDBY.SKIP` to Prevent Changes to Specific Schema Objects](#)
- [Setting up a Skip Handler for a DDL Statement](#)
- [Modifying a Logical Standby Database](#)
- [Adding or Re-Creating Tables On a Logical Standby Database](#)

### See Also:

The `DBMS_LOGSTDBY` package in *Oracle Database PL/SQL Packages and Types Reference*

## 11.5.1 Customizing Logging of Events in the DBA\_LOGSTDBY\_EVENTS View

The `DBA_LOGSTDBY_EVENTS` view can be thought of as a circular log containing the most recent interesting events that occurred in the context of SQL Apply.

By default the last 10,000 events are remembered in the event view. You can change the number of events logged by invoking the `DBMS_LOGSTDBY.APPLY_SET` procedure. For example, to ensure that the last 100,000 events are recorded, you can issue the following statement:

```
SQL> EXECUTE DBMS_LOGSTDBY.APPLY_SET ('MAX_EVENTS_RECORDED', '100000');
```

Errors that cause SQL Apply to stop are always recorded in the `DBA_LOGSTDBY_EVENTS` view (unless there is insufficient space in the `SYSTEM` tablespace). These events are always put into the alert file as well, with the keyword `LOGSTDBY` included in the text. When querying the view, select the columns in order by `EVENT_TIME`, `COMMIT_SCN`, and `CURRENT_SCN`. This ordering ensures a shutdown failure appears last in the view.

The following examples show `DBMS_LOGSTDBY` subprograms that specify events to be recorded in the view.

### Example 1: Determining if DDL Statements Have Been Applied

For example, to record applied DDL transactions to the `DBA_LOGSTDBY_EVENTS` view, issue the following statement:

```
SQL> EXECUTE DBMS_LOGSTDBY.APPLY_SET ('RECORD_APPLIED_DDL', 'TRUE');
```

### Example 2: Checking the DBA\_LOGSTDBY\_EVENTS View for Unsupported Operations

To capture information about transactions running on the primary database that are not supported by a logical standby database, issue the following statements:

```
SQL> ALTER DATABASE STOP LOGICAL STANDBY APPLY;SQL> EXEC  
DBMS_LOGSTDBY.APPLY_SET('RECORD_UNSUPPORTED_OPERATIONS', 'TRUE');SQL> ALTER  
DATABASE START LOGICAL STANDBY APPLY IMMEDIATE;
```

Then, check the `DBA_LOGSTDBY_EVENTS` view for any unsupported operations. Usually, an operation on an unsupported table is silently ignored by SQL Apply. However, during rolling upgrade (while the standby database is at a higher version and mining redo generated by a lower versioned primary database), if you performed an unsupported operation on the primary database, the logical standby database may not be the one to which you want to perform a switchover. Oracle Data Guard logs at least one unsupported operation per table in the `DBA_LOGSTDBY_EVENTS` view. [Using SQL Apply to Upgrade the Oracle Database](#) provides detailed information about rolling upgrades.

## 11.5.2 Using DBMS\_LOGSTDBY.SKIP to Prevent Changes to Specific Schema Objects

By default, all supported tables in the primary database are replicated in the logical standby database.

You can change the default behavior by specifying rules to skip applying modifications to specific tables. For example, to omit changes to the `HR.EMPLOYEES` table, you can specify rules to prevent application of DML and DDL changes to the specific table. For example:

1. Stop SQL Apply:

```
SQL> ALTER DATABASE STOP LOGICAL STANDBY APPLY;
```

2. Register the SKIP rules:

```
SQL> EXECUTE DBMS_LOGSTDBY.SKIP (stmt => 'DML', schema_name => 'HR', -
> object_name => 'EMPLOYEES');
```

```
SQL> EXECUTE DBMS_LOGSTDBY.SKIP (stmt => 'SCHEMA_DDL', schema_name => 'HR', -
> object_name => 'EMPLOYEES');
```

3. Start SQL Apply:

```
SQL> ALTER DATABASE START LOGICAL STANDBY APPLY IMMEDIATE;
```

## 11.5.3 Setting up a Skip Handler for a DDL Statement

You can create a procedure to intercept certain DDL statements and replace the original DDL statement with a different one.

For example, if the file system organization in the logical standby database is different than that in the primary database, you can write a `DBMS_LOGSTDBY.SKIP` procedure to transparently handle DDL transactions with file specifications.

The following procedure can handle different file system organization between the primary database and standby database, as long as you use a specific naming convention for your file-specification string.

1. Create the skip procedure to handle tablespace DDL transactions:

```
CREATE OR REPLACE PROCEDURE SYS.HANDLE_TBS_DDL (
  OLD_STMT IN VARCHAR2,
  STMT_TYP IN VARCHAR2,
  SCHEMA   IN VARCHAR2,
  NAME     IN VARCHAR2,
  XIDUSN   IN NUMBER,
  XIDSLT   IN NUMBER,
  XIDSQN   IN NUMBER,
  ACTION   OUT NUMBER,
  NEW_STMT OUT VARCHAR2
) AS
BEGIN

  -- All primary file specification that contains a directory
  -- /usr/orcl/primary/dbs
  -- should go to /usr/orcl/stdby directory specification
```

```

NEW_STMT := REPLACE(OLD_STMT,
                    '/usr/orcl/primary/dbs',
                    '/usr/orcl/standby');

ACTION := DBMS_LOGSTDBY.SKIP_ACTION_REPLACE;

EXCEPTION
  WHEN OTHERS THEN
    ACTION := DBMS_LOGSTDBY.SKIP_ACTION_ERROR;
    NEW_STMT := NULL;
END HANDLE_TBS_DDL;

```

## 2. Stop SQL Apply:

```
SQL> ALTER DATABASE STOP LOGICAL STANDBY APPLY;
```

## 3. Register the skip procedure with SQL Apply:

```
SQL> EXECUTE DBMS_LOGSTDBY.SKIP (stmt => 'TABLESPACE', -
> proc_name => 'sys.handle_tbs_ddl');
```

## 4. Start SQL Apply:

```
SQL> ALTER DATABASE START LOGICAL STANDBY APPLY IMMEDIATE;
```

## 11.5.4 Modifying a Logical Standby Database

Logical standby databases can be used for reporting activities, even while SQL statements are being applied.

The *database guard* controls user access to tables in a logical standby database, and the `ALTER SESSION DISABLE GUARD` statement is used to bypass the database guard and allow modifications to the tables in the logical standby database.

### Note:

To use a logical standby database to host other applications that process data being replicated from the primary database while creating other tables of their own, the database guard must be set to `STANDBY`. For such applications to work seamlessly, make sure that you are running with `PRESERVE_COMMIT_ORDER` set to `TRUE` (the default setting for SQL Apply). (See *Oracle Database PL/SQL Packages and Types Reference* for information about the `PRESERVE_COMMIT_ORDER` parameter in the `DBMS_LOGSTDBY` PL/SQL package.)

Issue the following SQL statement to set the database guard to `STANDBY`:

```
SQL> ALTER DATABASE GUARD STANDBY;
```

Under this guard setting, tables being replicated from the primary database are protected from user modifications, but tables created on the standby database can be modified by the applications running on the logical standby.

By default, a logical standby database operates with the database guard set to `ALL`, which is its most restrictive setting, and does not allow any user changes to be performed to the database. You can override the database guard to allow changes

to the logical standby database by executing the `ALTER SESSION DISABLE GUARD` statement. Privileged users can issue this statement to turn the database guard off for the current session.

The following sections provide some examples. The discussions in these sections assume that the database guard is set to `ALL` or `STANDBY`.

### 11.5.4.1 Performing DDL on a Logical Standby Database

You can add a constraint to a table maintained through SQL Apply.

By default, only accounts with `SYS` privileges can modify the database while the database guard is set to `ALL` or `STANDBY`. If you are logged in as `SYS``SDG`, `SYSTEM`, or another privileged account, you cannot issue DDL statements on the logical standby database without first bypassing the database guard for the session.

The following example shows how to stop SQL Apply, bypass the database guard, execute SQL statements on the logical standby database, and then reenables the guard. In this example, a soundex index is added to the surname column of `SCOTT.EMP` to speed up partial match queries. A soundex index could be prohibitive to maintain on the primary server.

```
SQL> ALTER DATABASE STOP LOGICAL STANDBY APPLY;
Database altered.

SQL> ALTER SESSION DISABLE GUARD;
PL/SQL procedure successfully completed.

SQL> CREATE INDEX EMP_SOUNDEX ON SCOTT.EMP(SOUNDEX(ENAME));
Table altered.

SQL> ALTER SESSION ENABLE GUARD;
PL/SQL procedure successfully completed.

SQL> ALTER DATABASE START LOGICAL STANDBY APPLY IMMEDIATE;
Database altered.

SQL> SELECT ENAME,MGR FROM SCOTT.EMP WHERE SOUNDEX(ENAME) = SOUNDEX('CLARKE');
```

| ENAME | MGR  |
|-------|------|
| CLARK | 7839 |

Oracle recommends that you do not perform DML operations on tables maintained by SQL Apply while the database guard bypass is enabled. Doing so introduces deviations between the primary and standby databases that make it impossible for the logical standby database to be maintained.

### 11.5.4.2 Modifying Tables That Are Not Maintained by SQL Apply

Sometimes, a reporting application must collect summary results and store them temporarily or track the number of times a report was run. Although the main purpose of the application is to perform reporting activities, the application might need to issue DML (insert, update, and delete) operations on a logical standby database. It might even need to create or drop tables. You can set up the database guard to allow reporting operations to modify data as long as the data is not being maintained through SQL Apply.

To do this, you must:

- Specify the set of tables on the logical standby database to which an application can write data by executing the `DBMS_LOGSTDBY.SKIP` procedure. Skipped tables are not maintained through SQL Apply.
- Set the database guard to protect only standby tables.

In the following example, it is assumed that the tables to which the report is writing are also on the primary database.

The example stops SQL Apply, skips the tables, and then restarts SQL Apply. The reporting application writes to `TESTEMP%` in `HR`. The tables are no longer maintained through SQL Apply.

```
SQL> ALTER DATABASE STOP LOGICAL STANDBY APPLY;
Database altered.

SQL> EXECUTE DBMS_LOGSTDBY.SKIP(stmt => 'SCHEMA_DDL', -
    schema_name => 'HR', -
    object_name => 'TESTEMP%');
PL/SQL procedure successfully completed.

SQL> EXECUTE DBMS_LOGSTDBY.SKIP('DML', 'HR', 'TESTEMP%');
PL/SQL procedure successfully completed.

SQL> ALTER DATABASE START LOGICAL STANDBY APPLY IMMEDIATE;
Database altered.
```

Once SQL Apply starts, it needs to update metadata on the standby database for the newly specified tables added in the skip rules. Attempts to modify the newly skipped table until SQL Apply has had a chance to update the metadata fail. You can find out if SQL Apply has successfully taken into account the `SKIP` rule you just added by issuing the following query:

```
SQL> SELECT VALUE FROM SYSTEM.LOGSTDBY$PARAMETERS WHERE NAME = 'GUARD_STANDBY';

VALUE
-----
Ready
```

When the `VALUE` column displays `Ready`, SQL Apply has successfully updated all relevant metadata for the skipped table, and it is safe to modify the table.



#### See Also:

[DDL Statements Supported by a Logical Standby Database](#) and the `DBMS_LOGSTDBY` package in *Oracle Database PL/SQL Packages and Types Reference*



## 11.5.5 Adding or Re-Creating Tables On a Logical Standby Database

Typically, you use the `DBMS_LOGSTDBY.INSTANTIATE_TABLE` procedure to re-create a table after an unrecoverable operation.

You can also use this procedure to enable SQL Apply on a table that was formerly skipped.

Before you can create a table, it must meet the requirements described in [Ensure Table Rows in the Primary Database Can Be Uniquely Identified](#). Then, you can use the following steps to re-create a table named `HR.EMPLOYEES` and resume SQL Apply. The directions assume that there is already a database link `BOSTON` defined to access the primary database.

The following list shows how to re-create a table and restart SQL Apply on that table:

1. Stop SQL Apply:

```
SQL> ALTER DATABASE STOP LOGICAL STANDBY APPLY;
```

2. Ensure no operations are being skipped for the table in question by querying the `DBA_LOGSTDBY_SKIP` view:

```
SQL> SELECT * FROM DBA_LOGSTDBY_SKIP;
```

| ERROR | STATEMENT_OPT | OWNER | NAME       | PROC |
|-------|---------------|-------|------------|------|
| N     | SCHEMA_DDL    | HR    | EMPLOYEES  |      |
| N     | DML           | HR    | EMPLOYEES  |      |
| N     | SCHEMA_DDL    | OE    | TEST_ORDER |      |
| N     | DML           | OE    | TEST_ORDER |      |

Because you already have skip rules associated with the table that you want to re-create on the logical standby database, you must first delete those rules. You can accomplish that by calling the `DBMS_LOGSTDBY.UNSKIP` procedure. For example:

```
SQL> EXECUTE DBMS_LOGSTDBY.UNSKIP(stmt => 'DML', -
> schema_name => 'HR', -
> object_name => 'EMPLOYEES');
```

```
SQL> EXECUTE DBMS_LOGSTDBY.UNSKIP(stmt => 'SCHEMA_DDL', -
> schema_name => 'HR', -
> object_name => 'EMPLOYEES');
```

3. Re-create the table `HR.EMPLOYEES` with all its data in the logical standby database by using the `DBMS_LOGSTDBY.INSTANTIATE_TABLE` procedure. For example:

```
SQL> EXECUTE DBMS_LOGSTDBY.INSTANTIATE_TABLE(schema_name => 'HR', -
> table_name => 'EMPLOYEES', -
> dblink => 'BOSTON');
```

4. Start SQL Apply:

```
SQL> ALTER DATABASE START LOGICAL STANDBY APPLY IMMEDIATE;
```

 **See Also:**

*Oracle Database PL/SQL Packages and Types Reference* for information about the `DBMS_LOGSTDBY.UNSKIP` and the `DBMS_LOGSTDBY.INSTANTIATE_TABLE` procedures

To ensure a consistent view across the newly instantiated table and the rest of the database, wait for SQL Apply to catch up with the primary database before querying this table. You can do this by performing the following steps:

1. On the primary database, determine the current SCN by querying the `V$DATABASE` view:

```
SQL> SELECT CURRENT_SCN FROM V$DATABASE@BOSTON;
```

```
CURRENT_SCN  
-----  
345162788
```

2. Make sure SQL Apply has applied all transactions committed before the `CURRENT_SCN` returned in the previous query:

```
SQL> SELECT APPLIED_SCN FROM V$LOGSTDBY_PROGRESS;
```

```
APPLIED_SCN  
-----  
345161345
```

When the `APPLIED_SCN` returned in this query is greater than the `CURRENT_SCN` returned in the first query, it is safe to query the newly re-created table.

## 11.6 Managing Specific Workloads In the Context of a Logical Standby Database

You can manage specific workloads in the context of a logical standby.

See the following:

- [Importing a Transportable Tablespace to the Primary Database](#)
- [Using Materialized Views](#)
- [How Triggers and Constraints Are Handled on a Logical Standby Database](#)
- [Using Triggers to Replicate Unsupported Tables](#)
- [Recovering Through the Point-in-Time Recovery Performed at the Primary](#)
- [Running an Oracle Streams Capture Process on a Logical Standby Database](#)

### 11.6.1 Importing a Transportable Tablespace to the Primary Database

A transportable tablespace can be imported to a primary database.

Perform the following steps:

1. Disable the guard setting so that you can modify the logical standby database:

```
SQL> ALTER DATABASE GUARD STANDBY;
```

2. Import the tablespace at the logical standby database.

3. Enable the database guard setting:

```
SQL> ALTER DATABASE GUARD ALL;
```

4. Import the tablespace at the primary database.

## 11.6.2 Using Materialized Views

Logical standby automatically skips DDL statements related to materialized views.

For example, logical standby skips the following statements:

- CREATE, ALTER, or DROP MATERIALIZED VIEW
- CREATE, ALTER or DROP MATERIALIZED VIEW LOG

New materialized views that are created, altered, or dropped on the primary database after the logical standby database has been created are not created on the logical standby database. However, materialized views created on the primary database prior to the logical standby database being created are present on the logical standby database.

Logical Standby supports the creation and maintenance of new materialized views locally on the logical standby database in addition to other kinds of auxiliary data structure. For example, online transaction processing (OLTP) systems frequently use highly normalized tables for update performance but these can lead to slower response times for complex decision support queries. Materialized views that denormalize the replicated data for more efficient query support on the logical standby database can be created, as follows (connect as user `SYS` before issuing these statements):

```
SQL> ALTER SESSION DISABLE GUARD;
```

```
SQL> CREATE MATERIALIZED VIEW LOG ON SCOTT.EMP -
> WITH ROWID (EMPNO, ENAME, MGR, DEPTNO) INCLUDING NEW VALUES;
```

```
SQL> CREATE MATERIALIZED VIEW LOG ON SCOTT.DEPT -
> WITH ROWID (DEPTNO, DNAME) INCLUDING NEW VALUES;
```

```
SQL> CREATE MATERIALIZED VIEW SCOTT.MANAGED_BY -
> REFRESH ON DEMAND -
> ENABLE QUERY REWRITE -
> AS SELECT E.ENAME, M.ENAME AS MANAGER -
> FROM SCOTT.EMP E, SCOTT.EMP M WHERE E.MGR=M.EMPNO;
```

```
SQL> CREATE MATERIALIZED VIEW SCOTT.IN_DEPT -
> REFRESH FAST ON COMMIT -
> ENABLE QUERY REWRITE -
> AS SELECT E.ROWID AS ERID, D.ROWID AS DRID, E.ENAME, D.DNAME -
> FROM SCOTT.EMP E, SCOTT.DEPT D WHERE E.DEPTNO=D.DEPTNO;
```

On a logical standby database:

- An ON-COMMIT materialized view is refreshed automatically on the logical standby database when the transaction commit occurs.
- An ON-DEMAND materialized view is not automatically refreshed: the `DBMS_MVIEW.REFRESH` procedure must be executed to refresh it.

For example, issuing the following command would refresh the ON-DEMAND materialized view created in the previous example:

```
SQL> ALTER SESSION DISABLE GUARD;

SQL> EXECUTE DBMS_MVIEW.REFRESH (LIST => 'SCOTT.MANAGED_BY', METHOD => 'C');
```

If `DBMS_SCHEDULER` jobs are being used to periodically refresh on-demand materialized views, the database guard must be set to `STANDBY`. (It is not possible to use the `ALTER SESSION DISABLE GUARD` statement inside a PL/SQL block and have it take effect.)

## 11.6.3 How Triggers and Constraints Are Handled on a Logical Standby Database

By default, triggers and constraints are automatically enabled and handled on logical standby databases.

For triggers and constraints on tables *maintained* by SQL Apply:

- Constraints — Check constraints are evaluated on the primary database and do not need to be re-evaluated on the logical standby database.
- Triggers — The effects of the triggers executed on the primary database are logged and applied on the standby database.

For triggers and constraints on tables *not maintained* by SQL Apply:

- Constraints are evaluated
- Triggers are fired

## 11.6.4 Using Triggers to Replicate Unsupported Tables

DML triggers created on a table have their `DBMS_DDL.SET_TRIGGER_FIRING_PROPERTY` `fire_once` parameter set to `TRUE` by default.

The triggers fire only when the table is modified by a user process. They are automatically disabled inside SQL Apply processes, and thus do not fire when a SQL Apply process modifies the table. There are two ways to fire a trigger as a result of SQL Apply process making a change to a maintained table:

- Set the `fire_once` parameter of a trigger to `FALSE`, which allows it to fire in either the context of a user process or a SQL Apply process
- Set the `apply_server_only` parameter to `TRUE` which results in the trigger firing only in the context of a SQL Apply process and not in the context of a user process

| <code>fire_once</code> | <code>apply_server_only</code> | description                                                                                                                                                                                                                   |
|------------------------|--------------------------------|-------------------------------------------------------------------------------------------------------------------------------------------------------------------------------------------------------------------------------|
| <code>TRUE</code>      | <code>FALSE</code>             | This is the default property setting for a DML trigger. The trigger fires only when a user process modifies the base table.                                                                                                   |
| <code>FALSE</code>     | <code>FALSE</code>             | The trigger fires in the context of a user process and in the context of a SQL Apply process modifying the base table. You can distinguish the two contexts by using the <code>DBMS_LOGSTDBY.IS_APPLY_SERVER</code> function. |

| fire_once      | apply_server_only | description                                                                                                                                                                                                                                                    |
|----------------|-------------------|----------------------------------------------------------------------------------------------------------------------------------------------------------------------------------------------------------------------------------------------------------------|
| TRUE/<br>FALSE | TRUE              | The trigger only fires when a SQL Apply process modifies the base table. The trigger does not fire when a user process modifies the base table. Thus, the <code>apply_server_only</code> property overrides the <code>fire_once</code> parameter of a trigger. |

Tables that are unsupported due to simple object type columns can be replicated by creating triggers that fire in the context of a SQL Apply process (either by setting the `fire_once` parameter of such a trigger to `FALSE` or by setting the `apply_server_only` parameter of such a trigger to `TRUE`). A regular DML trigger can be used on the primary database to flatten the object type into a table that can be supported. The trigger that fires in the context of a SQL Apply process on the logical standby reconstitutes the object type and updates the unsupported table in a transactional manner.

#### See Also:

- *Oracle Database PL/SQL Packages and Types Reference* for descriptions of the `DBMS_DDL.SET_TRIGGER FIRING_PROPERTY` procedure and the `DBMS_LOGSTDBY.IS_APPLY_SERVER` function

The following example shows how a table with a simple object type could be replicated using triggers. This example shows how to handle inserts; the same principle can be applied to updating and deleting. Nested tables and `VARRAYS` can also be replicated using this technique with the additional step of a loop to normalize the nested data.

```
-- simple object type
create or replace type Person as object
(
  FirstName   varchar2(50),
  LastName    varchar2(50),
  BirthDate   Date
)

-- unsupported object table
create table employees
(
  IdNumber    varchar2(10) ,
  Department  varchar2(50),
  Info        Person
)

-- supported table populated via trigger
create table employees_transfer
(
  t_IdNumber   varchar2(10),
  t_Department varchar2(50),
  t_FirstName  varchar2(50),
  t_LastName   varchar2(50),
  t_BirthDate  Date
)
--
-- create this trigger to flatten object table on the primary
```

```

-- this trigger will not fire on the standby
--
create or replace trigger flatten_employees
  after insert on employees for each row
declare
begin
  insert into employees_transfer
    (t_IdNumber, t_Department, t_FirstName, t_LastName, t_BirthDate)
  values
    (:new.IdNumber, :new.Department,
 :new.Info.FirstName, :new.Info.LastName, :new.Info.BirthDate);
end

--
-- Option#1 (Better Option: Create a trigger and
-- set its apply-server-only property to TRUE)
-- create this trigger at the logical standby database
-- to populate object table on the standby
-- this trigger only fires when apply replicates rows
-- to the standby
--
create or replace trigger reconstruct_employees_aso
  after insert on employees_transfer for each row
begin

  insert into employees (IdNumber, Department, Info)
  values (:new.t_IdNumber, :new.t_Department,
 Person(:new.t_FirstName, :new.t_LastName, :new.t_BirthDate));

end

-- set this trigger to fire from the apply server
execute dbms_ddl.set_trigger_firing_property( -
trig_owner => 'scott', -
trig_name  => 'reconstruct_employees_aso',
property => dbms_ddl.apply_server_only,
setting => TRUE);

--
-- Option#2 (Create a trigger and set
-- its fire-once property to FALSE)
-- create this trigger at the logical standby database
-- to populate object table on the standby
-- this trigger will fire when apply replicates rows to -- the standby, but we
will need to make sure we are
-- are executing inside a SQL Apply process by invoking
-- dbms_logstdby.is_apply_server function
--
create or replace trigger reconstruct_employees_nfo
  after insert on employees_transfer for each row
begin
  if dbms_logstdby.is_apply_server() then
    insert into employees (IdNumber, Department, Info)
    values (:new.t_IdNumber, :new.t_Department,
 Person(:new.t_FirstName, :new.t_LastName, :new.t_BirthDate));
  end if;
end

-- set this trigger to fire from the apply server
execute dbms_ddl.set_trigger_firing_property( -
trig_owner => 'scott', -

```

```

trig_name => 'reconstruct_employees_nfo',
property => dbms_ddl.fire_once,
setting => FALSE);

```

## 11.6.5 Recovering Through the Point-in-Time Recovery Performed at the Primary

When a logical standby database receives a new branch of redo data, SQL Apply automatically takes the new branch of redo data.

For logical standby databases, no manual intervention is required if the standby database did not apply redo data past the new resetlogs SCN (past the start of the new branch of redo data)

The following table describes how to resynchronize the standby database with the primary database branch.

| If the standby database. . .                                                                                                                                   | Then. . .                                                                                    | Perform these steps. . .                                                                                                                                                                                                                                                                                                                                                                          |
|----------------------------------------------------------------------------------------------------------------------------------------------------------------|----------------------------------------------------------------------------------------------|---------------------------------------------------------------------------------------------------------------------------------------------------------------------------------------------------------------------------------------------------------------------------------------------------------------------------------------------------------------------------------------------------|
| Has not applied redo data past the new resetlogs SCN (past the start of the new branch of redo data)                                                           | SQL Apply automatically takes the new branch of redo data.                                   | No manual intervention is necessary. SQL Apply automatically resynchronizes the standby database with the new branch of redo data.                                                                                                                                                                                                                                                                |
| Has applied redo data past the new resetlogs SCN (past the start of the new branch of redo data) and Flashback Database is enabled on the standby database     | The standby database is recovered <i>in the future</i> of the new branch of redo data.       | <ol style="list-style-type: none"> <li>1. Follow the procedure in <a href="#">Flashing Back a Logical Standby Database to a Specific Point-in-Time</a> to flash back a logical standby database.</li> <li>2. Restart SQL Apply to continue application of redo onto the new reset logs branch.</li> </ol> <p>SQL Apply automatically resynchronizes the standby database with the new branch.</p> |
| Has applied redo data past the new resetlogs SCN (past the start of the new branch of redo data) and Flashback Database is not enabled on the standby database | The primary database has diverged from the standby on the indicated primary database branch. | Re-create the logical standby database following the procedures in <a href="#">Creating a Logical Standby Database</a> .                                                                                                                                                                                                                                                                          |
| Is missing archived redo log files from the end of the previous branch of redo data                                                                            | SQL Apply cannot continue until the missing log files are retrieved.                         | Locate and register missing archived redo log files from the previous branch.                                                                                                                                                                                                                                                                                                                     |

See *Oracle Database Backup and Recovery User's Guide* for more information about database incarnations, recovering through an `OPEN RESETLOGS` operation, and Flashback Database.

## 11.6.6 Running an Oracle Streams Capture Process on a Logical Standby Database

You can run an Oracle Streams capture process on a logical standby database to capture changes from any table that exists on the logical standby database (whether it is a local table or a maintained table that is being replicated from the primary database).

When changes are captured to a maintained table, there is additional latency as compared to running an Oracle Streams capture process at the primary database. The additional latency is because of the fact that when you are running at a logical standby, the Oracle Streams capture process must wait for the changes to be shipped from the primary to the logical standby and applied by SQL Apply. In most cases, if you are running real time apply, it is no more than a few seconds.

The Oracle Streams capture process is associated with the database where it was created; the role of the database is irrelevant. For example, suppose you have a primary database named `Boston` and a logical standby named `London`. You cannot move the Oracle Streams capture process from one database to the other as you go through role transitions. For instance, if you created an Oracle Streams capture process on `London` when it was a logical standby, then it remains on `London` even when `London` becomes the primary as a result of a role transition operation such as a switchover or failover. For the Oracle Streams capture process to continue working after a role transition, you must write a role transition trigger such as the following:

```
create or replace trigger streams_aq_job_role_changel
after DB_ROLE_CHANGE on database
declare
cursor capture_aq_jobs is
  select job_name, database_role
  from dba_scheduler_job_roles
  where job_name like 'AQ_JOB%';
u capture_aq_jobs%ROWTYPE;
my_db_role varchar2(16);
begin

  if (dbms_logstdby.db_is_logstdby() = 1) then my_db_role := 'LOGICAL STANDBY';
  else my_db_role := 'PRIMARY';
  end if;

  open capture_aq_jobs;
  loop
    fetch capture_aq_jobs into u;
    exit when capture_aq_jobs%NOTFOUND;

    if (u.database_role != my_db_role) then
      dbms_scheduler.set_attribute(u.job_name,
        'database_role',
        my_db_role);

    end if;
  end loop;
  close capture_aq_jobs;

exception
  when others then
  begin
    raise;
  end;
end;
```

## 11.7 Tuning a Logical Standby Database

These topics provide information about various ways to tune logical standby databases.

- [Create a Primary Key RELY Constraint](#)



- [Gather Statistics for the Cost-Based Optimizer](#)
- [Adjust the Number of Processes](#)
- [Adjust the Memory Used for LCR Cache](#)
- [Adjust How Transactions are Applied On the Logical Standby Database](#)

## 11.7.1 Create a Primary Key RELY Constraint

On the primary database, if a table does not have a primary key or a unique index and you are certain the rows are unique, then create a primary key RELY constraint.

On the logical standby database, create an index on the columns that make up the primary key. The following query generates a list of tables with no index information that can be used by a logical standby database to apply to uniquely identify rows. By creating an index on the following tables, performance can be improved significantly.

```
SQL> SELECT OWNER, TABLE_NAME FROM DBA_TABLES -  
> WHERE OWNER NOT IN (SELECT OWNER FROM DBA_LOGSTDBY_SKIP -  
> WHERE STATEMENT_OPT = 'INTERNAL SCHEMA') -  
> MINUS -  
> SELECT DISTINCT TABLE_OWNER, TABLE_NAME FROM DBA_INDEXES -  
> WHERE INDEX_TYPE NOT LIKE ('FUNCTION-BASED%') -  
> MINUS -  
> SELECT OWNER, TABLE_NAME FROM DBA_LOGSTDBY_UNSUPPORTED;
```

You can add a rely primary key constraint to a table on the primary database, as follows:

1. Add the primary key rely constraint at the primary database:

```
SQL> ALTER TABLE HR.TEST_EMPLOYEES ADD PRIMARY KEY (EMPNO) RELY DISABLE;
```

This ensures that the EMPNO column, which can be used to uniquely identify the rows in HR.TEST\_EMPLOYEES table, is supplementally logged as part of any updates done on that table.

Note that the HR.TEST\_EMPLOYEES table still does not have any unique index specified on the logical standby database. This may cause UPDATE statements to do full table scans on the logical standby database. You can remedy that by adding a unique index on the EMPNO column on the logical standby database. See [Ensure Table Rows in the Primary Database Can Be Uniquely Identified](#) and *Oracle Database SQL Language Reference* for more information about RELY constraints.

Perform the remaining steps on the logical standby database.

2. Stop SQL Apply:

```
SQL> ALTER DATABASE STOP LOGICAL STANDBY APPLY;
```

3. Disable the guard so that you can modify a maintained table on the logical standby database:

```
SQL> ALTER SESSION DISABLE GUARD;
```

4. Add a unique index on EMPNO column:

```
SQL> CREATE UNIQUE INDEX UI_TEST_EMP ON HR.TEST_EMPLOYEES (EMPNO);
```

5. Enable the guard:

```
SQL> ALTER SESSION ENABLE GUARD;
```

#### 6. Start SQL Apply:

```
SQL> ALTER DATABASE START LOGICAL STANDBY APPLY IMMEDIATE;
```

## 11.7.2 Gather Statistics for the Cost-Based Optimizer

Statistics should be gathered on the standby database because the cost-based optimizer (CBO) uses them to determine the optimal query execution path.

New statistics should be gathered after the data or structure of a schema object is modified in ways that make the previous statistics inaccurate. For example, after inserting or deleting a significant number of rows into a table, collect new statistics on the number of rows.

Statistics should be gathered on the standby database because DML and DDL operations on the primary database are executed as a function of the workload. While the standby database is logically equivalent to the primary database, SQL Apply might execute the workload in a different way. This is why using the STATS pack on the logical standby database and the `V$SYSSTAT` view can be useful in determining which tables are consuming the most resources and table scans.



### See Also:

- [Ensure Table Rows in the Primary Database Can Be Uniquely Identified](#)

## 11.7.3 Adjust the Number of Processes

There are three parameters that can be modified to control the number of processes allocated to SQL Apply: `MAX_SERVERS`, `APPLY_SERVERS`, and `PREPARE_SERVERS`.

The following relationships must always hold true:

- $APPLY\_SERVERS + PREPARE\_SERVERS = MAX\_SERVERS - 3$

This is because SQL Apply always allocates one process for the `READER`, `BUILDER`, and `ANALYZER` roles.

- By default, `MAX_SERVERS` is set to 9, `PREPARE_SERVERS` is set to 1, and `APPLY_SERVERS` is set to 5.
- Oracle recommends that you only change the `MAX_SERVERS` parameter through the `DBMS_LOGSTDBY.APPLY_SET` procedure, and allow SQL Apply to distribute the server processes appropriately between prepare and apply processes.
- SQL Apply uses a process allocation algorithm that allocates 1 `PREPARE_SERVER` for every 20 server processes allocated to SQL Apply as specified by `MAX_SERVER` and limits the number of `PREPARE_SERVERS` to 5. Thus, if you set `MAX_SERVERS` to any value between 1 and 20, SQL Apply allocates 1 server process to act as a `PREPARER`, and allocates the rest of the processes as `APPLIERS` while satisfying the relationship previously described. Similarly, if you set `MAX_SERVERS` to a value between 21 and 40, SQL Apply allocates 2 server processes to act as `PREPARERS` and the rest as `APPLIERS`, while satisfying the relationship previously described. You can override this internal process allocation algorithm by

setting `APPLY_SERVERS` and `PREPARE_SERVERS` directly, provided that the previously described relationship is satisfied.

The following sections describe:

- [Adjusting the Number of APPLIER Processes](#)
- [Adjusting the Number of PREPARER Processes](#)

### 11.7.3.1 Adjusting the Number of APPLIER Processes

Before adjusting the number of `APPLIER` processes, you should determine whether doing so will help you achieve greater throughput.

To determine this, perform the following steps:

1. Check whether `APPLIER` processes are busy by issuing the following query:

```
SQL> SELECT COUNT(*) AS IDLE_APPLIER -
> FROM V$LOGSTDBY_PROCESS -
> WHERE TYPE = 'APPLIER' and status_code = 16116;
```

```
IDLE_APPLIER
-----
0
```

2. Once you are sure there are no idle `APPLIER` processes, issue the following query to ensure there is enough work available for additional `APPLIER` processes if you choose to adjust the number of `APPLIERS`:

```
SELECT NAME, VALUE FROM V$LOGSTDBY_STATS WHERE NAME = 'txns applied' OR NAME
= 'distinct txns in queue';
```

These two statistics keep a cumulative total of transactions that are ready to be applied by the `APPLIER` processes and the number of transactions that have already been applied.

If the number (`distinct txns in queue - txns applied`) is higher than twice the number of `APPLIER` processes available, an improvement in throughput is possible if you increase the number of `APPLIER` processes.

#### Note:

The number is a rough measure of ready work. The workload may be such that an interdependency between ready transactions prevents additional available `APPLIER` processes from applying them. For instance, if the majority of the transactions that are ready to be applied are DDL transactions, then adding more `APPLIER` processes does not result in a higher throughput.

Suppose you want to adjust the number of `APPLIER` processes to 20 from the default value of 5, while keeping the number of `PREPARER` processes to 1. Because you must satisfy the following equation:

$$\text{APPLY\_SERVERS} + \text{PREPARE\_SERVERS} = \text{MAX\_SERVERS} - 3$$

you must first set `MAX_SERVERS` to 24. Once you have done that, you can set the number of `APPLY_SERVERS` to 20, as follows:

```
SQL> EXECUTE DBMS_LOGSTDBY.APPLY_SET('MAX_SERVERS', 24);
SQL> EXECUTE DBMS_LOGSTDBY.APPLY_SET('APPLY_SERVERS', 20);
```

### 11.7.3.2 Adjusting the Number of PREPARER Processes

It is rare that you will need to adjust the number of `PREPARER` processes. Before increasing their number, you must ensure that certain conditions are true.

The conditions that must be true are as follows:

- All `PREPARER` processes are busy
- The number of transactions ready to be applied is less than the number of `APPLIER` processes available
- There are idle `APPLIER` processes

The following steps show how to determine these conditions are true:

**1. Ensure all `PREPARER` processes are busy:**

```
SQL> SELECT COUNT(*) AS IDLE_PREPARER -
> FROM V$LOGSTDBY_PROCESS -
> WHERE TYPE = 'PREPARER' and status_code = 16116;

IDLE_PREPARER
-----
0
```

**2. Ensure the number of transactions ready to be applied is less than the number of `APPLIER` processes:**

```
SQL> SELECT NAME, VALUE FROM V$LOGSTDBY_STATS WHERE NAME = 'txns applied' OR
- > NAME = 'distinct txns in queue';

NAME                                VALUE
-----                                -
txns applied                        27892
distinct txns in queue              12896
```

```
SQL> SELECT COUNT(*) AS APPLIER_COUNT -
> FROM V$LOGSTDBY_PROCESS WHERE TYPE = 'APPLIER';

APPLIER_COUNT
-----
20
```

Note: Issue this query several times to ensure this is not a transient event.

**3. Ensure there are idle `APPLIER` processes:**

```
SQL> SELECT COUNT(*) AS IDLE_APPLIER -
> FROM V$LOGSTDBY_PROCESS -
> WHERE TYPE = 'APPLIER' and status_code = 16116;

IDLE_APPLIER
-----
19
```

In the example, all three conditions necessary for increasing the number of PREPARER processes have been satisfied. Suppose you want to keep the number of APPLIER processes set to 20, and increase the number of PREPARER processes from 1 to 3. Because you always have to satisfy the following equation:

$$\text{APPLY\_SERVERS} + \text{PREPARE\_SERVERS} = \text{MAX\_SERVERS} - 3$$

you first need to increase the number MAX\_SERVERS from 24 to 26 to accommodate the increased number of preparers. You can then increase the number of PREPARER processes, as follows:

```
SQL> EXECUTE DBMS_LOGSTDBY.APPLY_SET('MAX_SERVERS', 26);
SQL> EXECUTE DBMS_LOGSTDBY.APPLY_SET('PREPARE_SERVERS', 3);
```

## 11.7.4 Adjust the Memory Used for LCR Cache

For some workloads, SQL Apply may use a large number of pageout operations, thereby reducing the overall throughput of the system. Increasing memory allocated to the LCR cache may help.

To determine whether increasing memory allocated to the LCR cache would be beneficial, perform the following steps:

1. Issue the following query to obtain a snapshot of pageout activity:

```
SQL> SELECT NAME, VALUE FROM V$LOGSTDBY_STATS WHERE NAME LIKE '%page%' -
> OR NAME LIKE '%uptime%' OR NAME LIKE '%idle%';
```

| NAME                         | VALUE  |
|------------------------------|--------|
| coordinator uptime (seconds) | 894856 |
| bytes paged out              | 20000  |
| pageout time (seconds)       | 2      |
| system idle time (seconds)   | 1000   |

2. Issue the query again in 5 minutes:

```
SQL> SELECT NAME, VALUE FROM V$LOGSTDBY_STATS WHERE NAME LIKE '%page%' -
> OR NAME LIKE '%uptime%' OR NAME LIKE '%idle%';
```

| NAME                         | VALUE   |
|------------------------------|---------|
| coordinator uptime (seconds) | 895156  |
| bytes paged out              | 1020000 |
| pageout time (seconds)       | 100     |
| system idle time (seconds)   | 1000    |

3. Compute the normalized pageout activity. For example:

```
Change in coordinator uptime (C)= (895156 - 894856) = 300 secs
Amount of additional idle time (I)= (1000 - 1000) = 0
Change in time spent in pageout (P) = (100 - 2) = 98 secs
Pageout time in comparison to uptime = P/(C-I) = 98/300 ~ 32.67%
```

Ideally, the pageout activity should not consume more than 5 percent of the total uptime. If you continue to take snapshots over an extended interval and you find the pageout activities continue to consume a significant portion of the apply time, increasing the memory size may provide some benefits. You can increase the memory allocated to SQL Apply by setting the memory allocated to LCR cache (for this example, the SGA is set to 1 GB):

```
SQL> EXECUTE DBMS_LOGSTDBY.APPLY_SET('MAX_SGA', 1024);  
PL/SQL procedure successfully completed
```

## 11.7.5 Adjust How Transactions are Applied On the Logical Standby Database

By default, transactions are applied on the logical standby database in the exact order in which they were committed on the primary database.

The strict default order of committing transactions allows any application to run transparently on the logical standby database.

However, many applications do not require such strict ordering among all transactions. Such applications do not require transactions containing non-overlapping sets of rows to be committed in the same order that they were committed at the primary database. This less strict ordering typically results in higher apply rates at the logical standby database. You can change the default order of committing transactions by performing the following steps:

1. Stop SQL Apply:

```
SQL> ALTER DATABASE STOP LOGICAL STANDBY APPLY;  
Database altered
```

2. Issue the following to allow transactions to be applied out of order from how they were committed on the primary databases:

```
SQL> EXECUTE DBMS_LOGSTDBY.APPLY_SET('PRESERVE_COMMIT_ORDER', 'FALSE');  
PL/SQL procedure successfully completed
```

3. Start SQL Apply:

```
SQL> ALTER DATABASE START LOGICAL STANDBY APPLY IMMEDIATE;  
Database altered
```

You can change back the apply mode as follows:

1. Stop SQL Apply:

```
SQL> ALTER DATABASE STOP LOGICAL STANDBY APPLY;  
Database altered
```

2. Restore the default value for the `PRESERVE_COMMIT_ORDER` parameter:

```
SQL> EXECUTE DBMS_LOGSTDBY.APPLY_UNSET('PRESERVE_COMMIT_ORDER');  
PL/SQL procedure successfully completed
```

3. Start SQL Apply:

```
SQL> ALTER DATABASE START LOGICAL STANDBY APPLY IMMEDIATE;  
Database altered
```

For a typical online transaction processing (OLTP) workload, the nondefault mode can provide a 50 percent or better throughput improvement over the default apply mode.

## 11.8 Backup and Recovery in the Context of a Logical Standby Database

You can back up your logical standby database using the traditional methods available and then recover it by restoring the database backup and performing media recovery on the archived logs, in conjunction with the backup.

The following items are relevant in the context of a logical standby database.

### Considerations When Creating and Using a Local RMAN Recovery Catalog

If you plan to create the RMAN recovery catalog or perform any RMAN activity that modifies the catalog, you must be running with `GUARD` set to `STANDBY` at the logical standby database.

You can leave `GUARD` set to `ALL`, if the local recovery catalog is kept only in the logical standby control file.

### Considerations For Control File Backup

Oracle recommends that you take a control file backup immediately after instantiating a logical standby database.

### Considerations For Point-in-Time Recovery

When SQL Apply is started for the first time following point-in-time recovery, it must be able to either find the required archived logs on the local system or to fetch them from the primary database. Use the `V$LOGSTDBY_PROCESS` view to determine if any archived logs need to be restored on the primary database.

### Considerations For Tablespace Point-in-Time Recovery

If you perform point-in-time recovery for a tablespace in a logical standby database, you must ensure one of the following:

- The tablespace contains no tables or partitions that are being maintained by the SQL Apply process
- If the tablespace contains tables or partitions that are being maintained by the SQL Apply process, then either use the `DBMS_LOGSTDBY.INSTANTIATE_TABLE` procedure to reinstantiate all of the maintained tables contained in the recovered tablespace at the logical standby database, or use `DBMS_LOGSTDBY.SKIP` procedure to register all tables contained in the recovered tablespace to be skipped from the maintained table list at the logical standby database.

# 12

## Using RMAN to Back Up and Restore Files

You can create backup strategies using Oracle Recovery Manager (RMAN) with Oracle Data Guard and standby databases.

RMAN can perform backups with minimal effect on the primary database and quickly recover from the loss of individual data files, or the entire database. RMAN and Oracle Data Guard can be used together to simplify the administration of an Oracle Data Guard configuration.

See the following topics:

- [About RMAN File Management in an Oracle Data Guard Configuration](#)
- [About RMAN Configuration in an Oracle Data Guard Environment](#)
- [Recommended RMAN and Oracle Database Configurations](#)
- [Backup Procedures](#)
- [Registering and Unregistering Databases in an Oracle Data Guard Environment](#)
- [Reporting in an Oracle Data Guard Environment](#)
- [Performing Backup Maintenance in an Oracle Data Guard Environment](#)
- [Recovery Scenarios in an Oracle Data Guard Environment](#)
- [Additional Backup Situations](#)
- [Restoring and Recovering Files Over the Network](#)
- [RMAN Support for CDBs In an Oracle Data Guard Environment](#)

### Note:

Because a logical standby database is not a block-for-block copy of the primary database, you cannot use a logical standby database to back up the primary database.

### See Also:

- *Oracle Database Backup and Recovery User's Guide* for more information about RMAN concepts and about using RMAN in an Oracle Data Guard environment
- *Oracle Database Backup and Recovery Reference* for detailed information about RMAN commands



## 12.1 About RMAN File Management in an Oracle Data Guard Configuration

RMAN uses a recovery catalog to track filenames for all database files in an Oracle Data Guard environment.

A recovery catalog is a database schema used by RMAN to store metadata about one or more Oracle databases. The catalog also records where the online redo logs, standby redo logs, tempfiles, archived redo logs, backup sets, and image copies are created.

### 12.1.1 Interchangeability of Backups in an Oracle Data Guard Environment

RMAN commands use the recovery catalog metadata to behave transparently across different physical databases in the Oracle Data Guard environment.

For example, you can back up a tablespace on a physical standby database and restore and recover it on the primary database. Similarly, you can back up a tablespace on a primary database and restore and recover it on a physical standby database.



#### Note:

Backups of logical standby databases are not usable at the primary database.

Backups of standby control files and nonstandby control files are interchangeable. For example, you can restore a standby control file on a primary database and a primary control file on a physical standby database. This interchangeability means that you can offload control file backups to one database in an Oracle Data Guard environment. RMAN automatically updates the filenames for database files during restore and recovery at the databases.

### 12.1.2 Association of Backups in an Oracle Data Guard Environment

The recovery catalog tracks the files in the Oracle Data Guard environment by associating every database file or backup file with a `DB_UNIQUE_NAME`.

The database that creates a file is associated with the file. For example, if RMAN backs up the database with the unique name of `standby1`, then `standby1` is associated with this backup. A backup remains associated with the database that created it unless you use the `CHANGE ... RESET DB_UNIQUE_NAME` to associate the backup with a different database.

## 12.1.3 Accessibility of Backups in an Oracle Data Guard Environment

By default, in an Oracle Data Guard environment, the recovery catalog considers disk backups as accessible only to the database with which it is associated, whereas tape backups created on one database are accessible to all databases.

You can override the default behavior by using the following RMAN command:

```
SET BACKUP FILES FOR DEVICE TYPE device_specifier TO [NOTACCESSIBLE | ACCESSIBLE]
```

The accessibility setting is at the session level which means that after the RMAN session is disconnected, the association of backups reverts back to default behavior.

If a backup file is not associated with any database, then the row describing it in the recovery catalog view shows `null` for the `SITE_KEY` column. By default, RMAN associates files whose `SITE_KEY` is `null` with the target database.

RMAN commands such as `BACKUP`, `RESTORE`, and `CROSSCHECK` work on any accessible backup. For example, for a `RECOVER COPY` operation, RMAN considers only image copies that are associated with the database as eligible to be recovered. RMAN considers the incremental backups on disk and tape as eligible to recover the image copies. In a database recovery, RMAN considers only the disk backups associated with the database and all files on tape as eligible to be restored.

To illustrate the differences in backup accessibility, assume that databases `prod` and `standby1` reside on different hosts. RMAN backs up data file 1 on `prod` to `/prmhost/disk1/df1.dbf` on the production host and also to tape. RMAN backs up data file 1 on `standby1` to `/sbyhost/disk2/df1.dbf` on the standby host and also to tape. If RMAN is connected to database `prod`, then you cannot use RMAN commands to perform operations with the `/sbyhost/disk2/df1.dbf` backup located on the standby host. However, RMAN does consider the tape backup made on `standby1` as eligible to be restored.

### Note:

You can FTP a backup from a standby host to a primary host or vice versa, connect as `TARGET` to the database on this host, and then `CATALOG` the backup. After a file is cataloged by the target database, the file is associated with the target database.

## 12.2 About RMAN Configuration in an Oracle Data Guard Environment

In an Oracle Data Guard configuration, the process of backing up control files, data files, and archived logs can be offloaded to the standby system, thereby minimizing the effect of backups on the production system.

These backups can be used to recover the primary or standby database.

RMAN uses the `DB_UNIQUE_NAME` initialization parameter to distinguish one database site from another database site. Thus, it is critical that the uniqueness of `DB_UNIQUE_NAME` be maintained in an Oracle Data Guard configuration.

Only the primary database must be explicitly registered using the `RMAN REGISTER DATABASE` command. You do this after connecting RMAN to the recovery catalog and primary database as target.

Use the `RMAN CONFIGURE` command to set the RMAN configurations. When the `CONFIGURE` command is used with the `FOR DB_UNIQUE_NAME` option, it sets the RMAN site-specific configuration for the database with the `DB_UNIQUE_NAME` you specify.

For example, after connecting to the recovery catalog, you could use the following commands at an RMAN prompt to set the default device type to `SBT` for the `BOSTON` database that has a `DBID` of `1625818158`. The `RMAN SET DBID` command is required only if you are not connected to a database as target.

```
SET DBID 1625818158;  
CONFIGURE DEFAULT DEVICE TYPE TO SBT FOR DB_UNIQUE_NAME BOSTON;
```

## 12.3 Recommended RMAN and Oracle Database Configurations

These configurations can simplify backup and recovery operations.

- [Oracle Database Configurations on Primary and Standby Databases](#)
- [RMAN Configurations at the Primary Database](#)
- [RMAN Configurations at a Standby Database Where Backups are Performed](#)
- [RMAN Configurations at a Standby Where Backups Are Not Performed](#)

### Configuration Assumptions

These configurations make the following assumptions:

- The standby database is a physical standby database, and backups are taken only on the standby database. See [Standby Databases Too Geographically Distant to Share Backups](#) for procedural changes if backups are taken on both primary and standby databases.
- An RMAN recovery catalog is required so that backups taken on one database server can be restored to another database server. It is not sufficient to use only the control file as the RMAN repository because the primary database has no knowledge of backups taken on the standby database.

The RMAN recovery catalog organizes backup histories and other recovery-related metadata in a centralized location. The recovery catalog is configured in a database and maintains backup metadata. A recovery catalog does not have the space limitations of the control file and can store more historical data about backups.

A catalog server, physically separate from the primary and standby sites, is recommended in an Oracle Data Guard configuration because a disaster at either site will not affect the ability to recover the latest backups.

 **See Also:**

*Oracle Database Backup and Recovery User's Guide* for more information about managing a recovery catalog

- All databases in the configuration use Oracle Database 11g Release 1 (11.1) or later.
- Oracle Secure Backup software or 3rd-party media management software is configured with RMAN to make backups to tape.

## 12.3.1 Oracle Database Configurations on Primary and Standby Databases

These Oracle Database configurations are recommended on every primary and standby database in the Oracle Data Guard environment.

- Configure a fast recovery area for each database (the recovery area is local to a database).

The fast recovery area is a single storage location on a file system or Oracle Automatic Storage Management (Oracle ASM) disk group where all files needed for recovery reside. These files include the control file, archived logs, online redo logs, flashback logs, and RMAN backups. As new backups and archived logs are created in the fast recovery area, older files (which are either outside of the retention period, or have been backed up to tertiary storage) are automatically deleted to make room for them. In addition, notifications can be set up to alert the DBA when space consumption in the fast recovery area is nearing its predefined limit. The DBA can then take action, such as increasing the recovery area space limit, adding disk hardware, or decreasing the retention period.

Set the following initialization parameters to configure the fast recovery area:

```
DB_RECOVERY_FILE_DEST = <file system location or Oracle ASM Disk Group>
DB_RECOVERY_FILE_DEST_SIZE = <disk space quota>
```

 **See Also:**

*Oracle Database Backup and Recovery User's Guide* for more information about configuring a fast recovery area

- Use a server parameter file (SPFILE) so that it can be backed up to save instance parameters in backups.
- Enable Flashback Database on primary and standby databases.

When Flashback Database is enabled, Oracle Database maintains flashback logs in the fast recovery area. These logs can be used to roll the database back to an earlier point in time, without requiring a complete restore.

 **See Also:**

*Oracle Database Backup and Recovery User's Guide* for more information about enabling Flashback Database

## 12.3.2 RMAN Configurations at the Primary Database

To simplify ongoing use of RMAN, you can set a number of persistent configuration settings for each database in the Oracle Data Guard environment.

These settings control many aspects of RMAN behavior. For example, you can configure the backup retention policy, default destinations for backups to tape or disk, default backup device type, and so on. You can use the `CONFIGURE` command to set and change RMAN configurations. The following RMAN configurations are recommended at the primary database:

1. Connect RMAN to the primary database and recovery catalog.
2. Configure the retention policy for the database as *n* days:

```
CONFIGURE RETENTION POLICY TO RECOVERY WINDOW OF <n> DAYS;
```

This configuration lets you keep the backups necessary to perform database recovery to any point in time within the specified number of days.

Use the `DELETE OBSOLETE` command to delete any backups that are not required (per the retention policy in place) to perform recovery within the specified number of days.

3. Specify when archived logs can be deleted with the `CONFIGURE ARCHIVELOG DELETION POLICY` command. For example, to delete logs after ensuring that they *shipped* to all destinations, use the following configuration:

```
CONFIGURE ARCHIVELOG DELETION POLICY TO SHIPPED TO ALL STANDBY;
```

To delete logs after ensuring that they *were applied* on all standby destinations, use the following configuration:

```
CONFIGURE ARCHIVELOG DELETION POLICY TO APPLIED ON ALL STANDBY;
```

4. Configure the connect string for the primary database and all standby databases, so that RMAN can connect remotely and perform resynchronization when the `RESYNC CATALOG FROM DB_UNIQUE_NAME` command is used. When you connect to the target instance, you must provide a net service name. This requirement applies even if the other database instance from where the resynchronization is done is on the local host. The target and remote instances must use the same `SYSDBA` (or `SYSBACKUP`) password, which means that both instances must already have password files. You can create the password file with a single password so you can start all the database instances with that password file. For example, if the TNS alias to connect to a standby in Boston is `boston_conn_str`, you can use the following command to configure the connect identifier for the `BOSTON` database site:

```
CONFIGURE DB_UNIQUE_NAME BOSTON CONNECT IDENTIFIER 'boston_conn_str';
```

Note that the `'boston_conn_str'` does not include a username and password. It contains only the Oracle Net service name that can be used from any database site to connect to the `BOSTON` database site.

After connect identifiers are configured for all standby databases, you can verify the list of standbys by using the `LIST DB_UNIQUE_NAME OF DATABASE` command.

#### See Also:

- *Oracle Database Backup and Recovery User's Guide* for more information about RMAN configurations
- *Oracle Database Backup and Recovery Reference* for more information about the RMAN `CONFIGURE` command

### 12.3.3 RMAN Configurations at a Standby Database Where Backups are Performed

These RMAN configurations are recommended at a standby database where backups are done.

1. Connect RMAN to the standby database (where backups are performed) as target, and to the recovery catalog.

2. Enable automatic backup of the control file and the server parameter file:

```
CONFIGURE CONTROLFILE AUTOBACKUP ON;
```

3. Skip backing up data files for which there already exists a valid backup with the same checkpoint:

```
CONFIGURE BACKUP OPTIMIZATION ON;
```

4. Configure the tape channels to create backups as required by media management software:

```
CONFIGURE CHANNEL DEVICE TYPE SBT PARMS '<channel parameters>';
```

5. Because the archived logs are backed up at the standby database, Oracle recommends that you configure the `BACKED UP` option for the log deletion policy:

```
CONFIGURE ARCHIVELOG DELETION POLICY BACKED UP n TIMES TO DEVICE TYPE SBT;
```

#### See Also:

*Oracle Database Backup and Recovery User's Guide* for more information about enabling deletion policies for archived redo logs

### 12.3.4 RMAN Configurations at a Standby Where Backups Are Not Performed

These RMAN configurations are recommended at a standby database where backups are *not* done.

1. Connect RMAN to the standby database as target, and to the recovery catalog.

2. Enable automatic deletion of archived logs once they are applied at the standby database (this is also applicable to all terminal databases when the cascading or far sync instance features are in use):

```
CONFIGURE ARCHIVELOG DELETION POLICY TO APPLIED ON ALL STANDBY;
```

## 12.4 Backup Procedures

You can use RMAN scripts and procedures to back up Oracle Database in an Oracle Data Guard configuration.

See the following topics:

- [Using Disk as Cache for Tape Backups](#)
- [Performing Backups Directly to Tape](#)



### Note:

Oracle's Maximum Availability Architecture (MAA) best practices recommend that backups be taken at both the primary and the standby databases to reduce MTTR, in case of double outages and to avoid introducing new site practices upon switchover and failover.

### Backups of Server Parameter Files

All backup operations can be offloaded to a single standby database, except backups of the SPFILE. Backups of the SPFILE can only be restored to the database from which they were backed up.

For databases that are not backed up, Oracle recommends that you at least back up the SPFILE to a known local disk location. If the SPFILE backups need to be further backed up to tape, you can copy them to the database site where backups to tape have been configured. The SPFILE backups can then be cataloged at that database using the following RMAN command:

```
CATALOG START WITH '<SPFILE backup directory>';
```

Then back up the SPFILE backups to tape:

```
BACKUP BACKUPSET ALL;
```

When the SPFILE needs to be restored for a specific database, the appropriate SPFILE backup is restored from disk or tape.

### 12.4.1 Using Disk as Cache for Tape Backups

The fast recovery area on the standby database can serve as a disk cache for tape backup.

Disk is used as the primary storage for backups, with tape providing long term, archival storage. Incremental tape backups are taken daily and full tape backups are taken weekly. The commands used to perform these backups are described in the following sections.

### 12.4.1.1 Commands for Daily Tape Backups Using Disk as Cache

When deciding on your backup strategy, Oracle recommends that you take advantage of daily incremental backups.

Data file image copies can be rolled forward with the latest incremental backups, thereby providing up-to-date data file image copies at all times. RMAN uses the resulting image copy for media recovery just as it would use a full image copy taken at that system change number (SCN), without the overhead of performing a full image copy of the database every day. An additional advantage is that the time-to-recover is reduced because the image copy is updated with the latest block changes and fewer redo logs are required to bring the database back to the current state.

To implement daily incremental backups, a full database backup is taken on the first day, followed by an incremental backup on day two. Archived redo logs can be used to recover the database to any point in either day. For day three and onward, the previous day's incremental backup is merged with the data file copy and a current incremental backup is taken, allowing fast recovery to any point within the last day. Redo logs can be used to recover the database to any point during the current day.

The script to perform daily backups looks as follows (the last line, `DELETE ARCHIVELOG ALL` is only needed if the fast recovery area is not used to store logs):

```
RESYNC CATALOG FROM DB_UNIQUE_NAME ALL;  
RECOVER COPY OF DATABASE WITH TAG 'OSS';  
BACKUP DEVICE TYPE DISK INCREMENTAL LEVEL 1 FOR RECOVER OF COPY WITH TAG 'OSS'  
DATABASE;  
BACKUP DEVICE TYPE DISK DATAFILECOPY ALL NOT BACKED UP AT ANY SCN;  
BACKUP DEVICE TYPE SBT ARCHIVELOG ALL;  
BACKUP BACKUPSET ALL;  
DELETE ARCHIVELOG ALL;
```

The standby control file is automatically backed up at the conclusion of the backup operation because the control file auto backup is enabled.

Explanations for what each command in the script does are as follows:

- `RESYNC CATALOG FROM DB_UNIQUE_NAME ALL`  
Resynchronizes the information from all other database sites (primary and other standby databases) in the Oracle Data Guard setup that are known to recovery catalog. For `RESYNC CATALOG FROM DB_UNIQUE_NAME` to work, RMAN must be connected to the target using the Oracle Net service name and all databases must use the same password file.
- `RECOVER COPY OF DATABASE WITH TAG 'OSS'`  
Rolls forward level 0 copy of the database by applying the level 1 incremental backup taken the day before. In the example script just shown, the previous day's incremental level 1 was tagged `OSS`. This incremental is generated by the `BACKUP DEVICE TYPE DISK ... DATABASE` command. On the first day this command is run there is no roll forward because there is no incremental level 1 yet. A level 0 incremental is created by the `BACKUP DEVICE TYPE DISK ... DATABASE` command. Again on the second day there is no roll forward because there is only a level 0 incremental. A level 1 incremental tagged `OSS` is created by the `BACKUP DEVICE TYPE DISK ... DATABASE` command. On the third and following days, the roll forward is performed using the level 1 incremental tagged `OSS` created on the previous day.



- `BACKUP DEVICE TYPE DISK INCREMENTAL LEVEL 1 FOR RECOVER OF COPY WITH TAG 'OSS' DATABASE`

Create a new level 1 incremental backup. On the first day this command is run, a base datafile copy is created. On the second and following days, this is a level 1 incremental.

- `BACKUP DEVICE TYPE DISK DATAFILECOPY ALL NOT BACKED UP AT ANY SCN`  
Backs up only the data files that have not yet been backed up.

- `BACKUP DEVICE TYPE SBT ARCHIVELOG ALL`

Backs up archived logs to tape according to the deletion policy in place.

- `BACKUP BACKUPSET ALL`

Backs up any backup sets created as a result of incremental backup creation.

- `DELETE ARCHIVELOG ALL`

Deletes archived logs according to the log deletion policy set by the `CONFIGURE ARCHIVELOG DELETION POLICY` command. If the archived logs are in a fast recovery area, then they are automatically deleted when more open disk space is required. Therefore, you only need to use this command if you explicitly want to delete logs each day.

### 12.4.1.2 Commands for Weekly Tape Backups Using Disk as Cache

To back up all recovery-related files to tape, use the `RMAN BACKUP RECOVERY FILES` command once a week.

This ensures that all current incremental, image copy, and archived log backups on disk are backed up to tape.

## 12.4.2 Performing Backups Directly to Tape

Oracle's Media Management Layer (MML) API lets third-party vendors build a media manager, software that works with RMAN and the vendor's hardware to allow backups to sequential media devices such as tape drives.

A media manager handles loading, unloading, and labeling of sequential media such as tapes. You must install Oracle Secure Backup or third-party media management software to use RMAN with sequential media devices.

Take the following steps to perform backups directly to tape, by default:

1. Connect RMAN to the standby database (as the target database) and recovery catalog.
2. Execute the `CONFIGURE` command as follows:

```
CONFIGURE DEFAULT DEVICE TYPE TO SBT;
```

In this scenario, full backups are taken weekly, with incremental backups taken daily on the standby database.

 **See Also:**

*Oracle Database Backup and Recovery User's Guide* for more information about how to configure RMAN for use with a media manager

### 12.4.2.1 Commands for Daily Backups Directly to Tape

The RMAN commands used to perform daily backups directly to tape resynchronize the information from all other databases in the Oracle Data Guard environment.

Take the following steps to perform daily backups directly to tape:

1. Connect RMAN to the standby database (as target database) and to the recovery manager.
2. Execute the following RMAN commands:

```
RESYNC CATALOG FROM DB_UNIQUE_NAME ALL;  
BACKUP AS BACKUPSET INCREMENTAL LEVEL 1 DATABASE PLUS ARCHIVELOG;  
DELETE ARCHIVELOG ALL;
```

These commands also create a level 1 incremental backup of the database, including all archived logs. On the first day this script is run, if no level 0 backups are found, then a level 0 backup is created.

The `DELETE ARCHIVELOG ALL` command is necessary only if all archived log files are not in a fast recovery area.

### 12.4.2.2 Commands for Weekly Backups Directly to Tape

One day a week, perform a weekly backup directly to tape.

Take the following steps:

1. Connect RMAN to the standby database (as target database) and to the recovery catalog.
2. Execute the following RMAN commands:

```
RESYNC CATALOG FROM DB_UNIQUE_NAME ALL;  
BACKUP AS BACKUPSET INCREMENTAL LEVEL 0 DATABASE PLUS ARCHIVELOG;  
DELETE ARCHIVELOG ALL;
```

These commands resynchronize the information from all other databases in the Oracle Data Guard environment, and create a level 0 database backup that includes all archived logs.

The `DELETE ARCHIVELOG ALL` command is necessary only if all archived log files are not in a fast recovery area.

## 12.5 Registering and Unregistering Databases in an Oracle Data Guard Environment

Only the primary database must be explicitly registered using the `REGISTER DATABASE` command. Do this after connecting RMAN to the recovery catalog and primary database as `TARGET`.

A new standby is automatically registered in the recovery catalog when you connect to a standby database or when the `CONFIGURE DB_UNIQUE_NAME` command is used to configure the connect identifier.

To unregister information about a specific standby database, you can use the `UNREGISTER DB_UNIQUE_NAME` command. When a standby database is completely removed from an Oracle Data Guard environment, the database information in the recovery catalog can also be removed after you connect to another database in the same Oracle Data Guard environment. The backups that were associated with the database that was unregistered are still usable by other databases. You can associate these backups with any other existing database by using the `CHANGE BACKUP RESET DB_UNIQUE_NAME` command.

When the `UNREGISTER DB_UNIQUE_NAME` command is used with the `INCLUDING BACKUPS` option, the metadata for all the backup files associated with the database being unregistered is also unregistered from the recovery catalog.

## 12.6 Reporting in an Oracle Data Guard Environment

Use the `RMAN LIST`, `REPORT`, and `SHOW` commands with the `FOR DB_UNIQUE_NAME` clause to view information about a specific database.

For example, after connecting to the recovery catalog, you could use the following commands to display information for a database with a `DBID` of 1625818158 and to list the database in the Oracle Data Guard environment. The `SET DBID` command is required only if you are not connected to a database as `TARGET`. The last three commands list archive logs, database file names, and RMAN configuration information for a database with a `DB_UNIQUE_NAME` of `BOSTON`.

```
SET DBID 1625818158;
LIST DB_UNIQUE_NAME OF DATABASE;
LIST ARCHIVELOG ALL FOR DB_UNIQUE_NAME BOSTON;
REPORT SCHEMA FOR DB_UNIQUE_NAME BOSTON;
SHOW ALL FOR DB_UNIQUE_NAME BOSTON;
```

## 12.7 Performing Backup Maintenance in an Oracle Data Guard Environment

The files in an Oracle Data Guard environment (data files, archived logs, backup pieces, image copies, and proxy copies) are associated with a database through use of the `DB_UNIQUE_NAME` parameter.

Therefore, it is important that the value supplied for `DB_UNIQUE_NAME` be unique for each database in an Oracle Data Guard environment. This information, along with

file-sharing attributes, is used to determine which files can be accessed during various RMAN operations.

File sharing attributes state that files on disk are accessible only at the database with which they are associated, whereas all files on tape are assumed to be accessible by all databases. RMAN commands such as `BACKUP` and `RESTORE`, as well as other maintenance commands, work according to this assumption. For example, during a roll-forward operation of an image copy at a database, only image copies associated with the database are rolled forward. The incremental backups on disk associated with that database and any incremental backups on tape are used to roll forward the image copies. Similarly, during recovery operations, only disk backups associated with the database and files on tape are considered as sources for backups.

 **See Also:**

*Oracle Database Backup and Recovery Reference* for detailed information about RMAN commands

## 12.7.1 Changing Metadata in the Recovery Catalog

The RMAN `CHANGE` command can be used with various operands to change metadata in the recovery catalog.

For example:

- Changing File Association From One Standby Database to Another

Use the `CHANGE` command with the `RESET DB_UNIQUE_NAME` option to alter the association of files from one database to another within an Oracle Data Guard environment. The `CHANGE` command is useful when disk backups or archived logs are transferred from one database to another and you want to use them on the database to which they were transferred. The `CHANGE` command can also change the association of a file from one database to another database, without having to directly connect to either database using the `FOR DB_UNIQUE_NAME` and `RESET DB_UNIQUE_NAME TO` options.

- Changing the `DB_UNIQUE_NAME` Initialization Parameter for a Database

If the value of the `DB_UNIQUE_NAME` initialization parameter changes for a database, then the same change must be made in the Oracle Data Guard environment. The RMAN recovery catalog, after connecting to that database instance, knows both the old and new value for `DB_UNIQUE_NAME`. To merge the information for the old and new values within the recovery catalog schema, you must use the RMAN `CHANGE DB_UNIQUE_NAME` command. If the value of the `DB_UNIQUE_NAME` initialization parameter changes for a database, the same change must be made in RMAN so that it is aware of the new `DB_UNIQUE_NAME`. For example, perform the following steps to change the database with `DB_UNIQUE_NAME` of `BOSTON_A` to `BOSTON_B`:

1. In the initialization parameter file or SQL, change the `DB_UNIQUE_NAME` initialization parameter from `BOSTON_A` to `BOSTON_B`.

2. In RMAN, connect to any database in the Oracle Data Guard environment as target database and connect to the recovery catalog. Then execute the `CHANGE` command:

```
CHANGE DB_UNIQUE_NAME FROM BOSTON_A TO BOSTON_B;
```

- Making Backups Unavailable or Removing Their Metadata

Use `CHANGE` command options such as `AVAILABLE`, `UNAVAILABLE`, `KEEP`, and `UNCATALOG` to make backups available or unavailable for restore and recovery purposes, and to keep or remove their metadata.

 **See Also:**

*Oracle Database Backup and Recovery Reference* for more information about the RMAN `CHANGE` command

## 12.7.2 Deleting Archived Logs or Backups

Use the RMAN `DELETE` command to delete backup sets, image copies, archived logs, or proxy copies.

To delete only files that are associated with a specific database, you must use the `FOR DB_UNIQUE_NAME` option with the `DELETE` command.

File metadata is deleted for all successfully deleted files associated with the current target database (or for files that are not associated with any known database). If a file could not be successfully deleted, you can use the `FORCE` option to remove the file's metadata.

When a file associated with another database is deleted successfully, its metadata in the recovery catalog is also deleted. Any files that are associated with other databases, and that could not be successfully deleted, are listed at the completion of the `DELETE` command, along with instructions for you to perform the same operation at the database with which the files are associated (files are grouped by database). The `FORCE` option cannot be used to override this behavior. If you are certain that deleting the metadata for the non-deletable files will not cause problems, you can use the `CHANGE RESET DB_UNIQUE_NAME` command to change the metadata for association of files with the database and use the `DELETE` command with the `FORCE` option to delete the metadata for the file.

 **See Also:**

*Oracle Database Backup and Recovery Reference* for more information about the RMAN `DELETE` command

## 12.7.3 Validating Recovery Catalog Metadata

Use the `CROSSCHECK` command to validate and update file status in the recovery catalog schema.

Metadata for all files associated with the current target database (or for any files that are not associated with any database), is marked `AVAILABLE` or `EXPIRED` according to the results of the `CROSSCHECK` operation.

If a file associated with another database is successfully inspected, its metadata in the recovery catalog is also changed to `AVAILABLE`. Any files that are associated with other databases, and that could not be inspected successfully, are listed at the completion of the `CROSSCHECK` command, along with instructions for you to perform the same operation at the database with which the files are associated (files are grouped by site). If you are certain of the configuration and still want to change status metadata for unavailable files, you can use the `CHANGE RESET DB_UNIQUE_NAME` command to change metadata for association of files with the database and execute the `CROSSCHECK` command to update status metadata to `EXPIRED`.

 **See Also:**

*Oracle Database Backup and Recovery Reference* for more information about the `RMAN CROSSCHECK` command

## 12.8 Recovery Scenarios in an Oracle Data Guard Environment

These are some of recovery scenarios that can occur in an Oracle Data Guard environment.

- [Recovery from Loss of Files on the Primary or Standby Database](#)
- [Recovery from Loss of Online Redo Log Files](#)
- [Incomplete Recovery of the Primary Database](#)
- [Actions Needed on Standby After TSPITR or Tablespace Plugin at Primary](#)

### 12.8.1 Recovery from Loss of Files on the Primary or Standby Database

You can restore and recover files over the network by connecting to a physical standby database that contains the required files.

This can be useful when you want to restore lost data files, control files, or tablespaces on a primary database using the corresponding files on the physical standby database. You can also use the same process to restore files on a physical standby database by using the primary database.

 **Note:**

In releases prior to Oracle Database 12c, to recover from loss of files on the primary, you used the RMAN recovery catalog, and the RMAN `BACKUP`, `CATALOG DATAFILE`, and `SWITCH DATAFILE` commands. To recover from loss of files on the standby, you used the `RESTORE` and `RECOVER` commands. Those methods are no longer necessary as of Oracle Database 12c. If you need information about using them, refer to Oracle Database 11g documentation.

 **See Also:**

- *Oracle Database Backup and Recovery User's Guide* for more information about using RMAN to restore and recover files over the network

## 12.8.2 Recovery from Loss of Online Redo Log Files

If all online log members for the current `ACTIVE` group or for an inactive group which has not yet been archived are lost, then you must fail over to the standby database.

Refer to [Role Transitions](#) for the failover procedure.

For information about how to recover from the loss of online redo log files in other circumstances, see *Oracle Database Backup and Recovery User's Guide*.

## 12.8.3 Incomplete Recovery of the Primary Database

Incomplete recovery of the primary database is normally done in cases such as when the database is logically corrupted (by a user or an application) or when a tablespace or data file was accidentally dropped from database.

Depending on the current database checkpoint SCN on the standby database instances, you can use one of the following procedures to perform incomplete recovery of the primary database. All the procedures are in order of preference, starting with the one that is the least time consuming.

### Using Flashback Database

Using Flashback Database is the recommended procedure when the Flashback Database feature is enabled on the primary database, none of the database files are lost, and the point-in-time recovery is greater than the oldest flashback SCN or the oldest flashback time. See [Using Flashback Database After Issuing an Open Resetlogs Statement](#) for the procedure to use Flashback Database to do point-in-time recovery.

### Using the standby database instance

This is the recommended procedure when the standby database is behind the desired incomplete recovery time, and Flashback Database is not enabled on the primary or standby databases:

1. Recover the standby database to the desired point in time. Be sure to stop the managed redo process (MRP) before issuing the following command:

```
RECOVER DATABASE UNTIL TIME 'time';
```

Alternatively, incomplete recovery time can be specified using the SCN or log sequence number:

```
RECOVER DATABASE UNTIL SCN incomplete recovery SCN;  
RECOVER DATABASE UNTIL LOGSEQ incomplete recovery log sequence number THREAD  
thread number;
```

2. Open the standby database in read-only mode to verify the state of database.

If the state is not what is desired, use the LogMiner utility to look at the archived redo log files to find the right target time or SCN for incomplete recovery.

Alternatively, you can start by recovering the standby database to a point that you know is before the target time, and then open the database in read-only mode to examine the state of the data. Repeat this process until the state of the database is verified to be correct. If you recover the database too far (past the SCN where the error occurred) you cannot return it to an earlier SCN.

3. Activate the standby database using the SQL `ALTER DATABASE ACTIVATE STANDBY DATABASE` statement. This converts the standby database to a primary database, creates a new resetlogs branch, and opens the database. See [Recovering Through the OPEN RESETLOGS Statement](#) to learn how the standby database reacts to the new reset logs branch.

### Using the primary database instance

If all of the standby database instances have already been recovered past the desired point in time and Flashback Database is not enabled on the primary or standby database, then this is your only option.

Use the following procedure to perform incomplete recovery on the primary database:

1. Use LogMiner or another means to identify the time or SCN at which all the data in the database is known to be good.
2. Using the time or SCN, issue the following RMAN commands to do incomplete database recovery and open the database with the `RESETLOGS` option (after connecting to catalog database and primary instance that is in `MOUNT` state):

```
RUN  
{  
  SET UNTIL TIME 'time';  
  RESTORE DATABASE;  
  RECOVER DATABASE;  
}  
ALTER DATABASE OPEN RESETLOGS;
```

After this process, all standby database instances must be reestablished in the Oracle Data Guard configuration.



## 12.8.4 Actions Needed on Standby After TSPITR or Tablespace Plugin at Primary

After an RMAN tablespace point-in-time recovery (TSPITR) is performed at the primary, the recovered data files have a new system change number (SCN), and are therefore treated like new data files at the primary.

These data files cannot be automatically created at the standby.

Likewise, when a new plugged in tablespace is added to the primary database, the data files are treated like new data files at the primary.

The managed redo process (MRP) at the standby stops when the Redo Apply process encounters creation of these new files. The required new data files must be copied and restored to the standby. You can do this using either backups or a direct copy from the primary. For example, to copy all files that belong to a tablespace that has undergone an RMAN TSPITR, you can use the following RMAN command:

```
RMAN> RESTORE TABLESPACE <tbs_name1, tbs_name2> FROM SERVICE <tnsalias-of-  
primary>
```

The number of disk channels allocated is per RMAN configurations. So, if `CONFIGURE DEVICE TYPE DISK PARALLELISM 4` is executed, then 4 disk channels are used to pull the files from the primary database.

When the new data files are available at the standby, restart the MRP to continue applying the logs.

### See Also:

- *Oracle Database Backup and Recovery User's Guide* for more information about RMAN TSPITR

## 12.9 Additional Backup Situations

You can modify the backup procedures for other configurations, such as when the standby and primary databases cannot share backup files; the standby instance is only used to remotely archive redo log files; or the standby database filenames are different than the primary database.

### 12.9.1 Standby Databases Too Geographically Distant to Share Backups

If the standby databases are far apart from one another, then the backups taken on them may not be easily accessible by the primary system or other standby systems.

Perform a complete backup of the database on all systems to perform recovery operations. The fast recovery area can reside locally on the primary and standby systems; it does not have to be the same for the primary and standby databases.

In this scenario, you can still use the general strategies described in [Recovery Scenarios in an Oracle Data Guard Environment](#), with the following exceptions:

- Backup files created by RMAN must be tagged with the local system name, and with `RESTORE` operations that tag must be used to restrict RMAN from selecting backups taken on the same host. In other words, the `BACKUP` command must use the `TAG system name` option when creating backups; the `RESTORE` command must use the `FROM TAG system name` option; and the `RECOVER` command must use the `FROM TAG system name ARCHIVELOG TAG system name` option.
- Disaster recovery of the standby site:
  1. Start the standby instance in the `NOMOUNT` state using the same parameter files with which the standby was operating earlier.
  2. Create a standby control file on the primary instance using the SQL `ALTER DATABASE CREATE STANDBY CONTROLFILE AS filename` statement, and use the created control file to mount the standby instance.
  3. Issue the following RMAN commands to restore and recover the database files:
 

```
RESTORE DATABASE FROM TAG 'system name';
RECOVER DATABASE FROM TAG 'system name' ARCHIVELOG TAG 'system name';
```
  4. Restart Redo Apply.

The standby instance fetches the remaining archived redo log files.

## 12.9.2 Standby Database Does Not Contain Data Files, Used as a FAL Server

The FAL server can be used as a backup source for all archived redo log files, thus off-loading backups of archived redo log files to the FAL server.

Use the same procedure described in [Backup Procedures](#), with the exception that the RMAN commands that back up database files cannot be run against the FAL server.

## 12.9.3 Standby Database File Names Are Different From Primary Database

As of Oracle Database 11g, the recovery catalog can resynchronize the file names from each standby database site.

However, if the database filenames are not the same on the primary and standby databases that were never resynchronized, then the `RESTORE` and `RECOVER` commands you use are slightly different. To obtain the actual data file names on the standby database, query the `V$DATAFILE` view and specify the `SET NEWNAME` option for all the data files in the database:

```
RUN
{
SET NEWNAME FOR DATAFILE 1 TO 'existing file location for file#1 from V$DATAFILE';
SET NEWNAME FOR DATAFILE 2 TO 'existing file location for file#2 from V$DATAFILE';
...
...
SET NEWNAME FOR DATAFILE n TO 'existing file location for file#n from V$DATAFILE';
RESTORE {DATAFILE <n,m,...> | TABLESPACE tbs_name_1, 2, ...} DATABASE;
SWITCH DATAFILE ALL;
```

```
RECOVER DATABASE {NOREDO};  
}
```

Similarly, you use the `SET NEWNAME` option of the `RMAN DUPLICATE` command to specify new filenames during standby database creation. Or you could set the `LOG_FILE_NAME_CONVERT` and `DB_FILE_NAME_CONVERT` parameters.

 **See Also:**

[Creating a Standby Database That Uses OMF or Oracle ASM](#) for information about precedence rules when both the `DB_FILE_NAME_CONVERT` and `DB_CREATE_FILE_DEST` parameters are set on the standby

## 12.10 Restoring and Recovering Files Over the Network

As of Oracle Database 12c, RMAN lets you restore or recover files by connecting, over the network, to a physical standby database that contains the required files.

You can restore an entire database, data files, control files, spfile, or tablespaces. Restoring files over the network is very useful in scenarios where you need to synchronize the primary and standby databases.

RMAN restores database files, over the network, from a physical standby database by using the `FROM SERVICE` clause of the `RESTORE` command. The `FROM SERVICE` clause provides the service name of the physical standby database from which the files must be restored. During the restore operation, RMAN creates backup sets, on the physical standby database, of the files that need to be restored and then transfers these backup sets to the target database over the network.

 **Note:**

In releases prior to Oracle Database 12c, to restore and recover files over the network, you used the `RMAN BACKUP INCREMENTAL FROM SCN` command to create a backup on the primary database that started at the current SCN of the standby, and was then used to roll the standby database forward in time. That manual, multi-step method is not necessary as of Oracle Database 12c. If you need information about using that method, refer to Oracle Database 11g documentation.

 **See Also:**

- *Oracle Database Backup and Recovery User's Guide* for more information about using RMAN to restore and recover files over the network
- My Oracle Support note 2005729.1 at <http://support.oracle.com> for information about reducing transportable tablespace downtime using cross-platform incremental backups.

## 12.11 Rolling Forward a Standby With One Command

As of Oracle Database 18c, you can refresh a standby database over the network using one RMAN command, `RECOVER STANDBY DATABASE`.

The `RECOVER STANDBY DATABASE` command restarts the standby instance, refreshes the control file from the primary database, and automatically renames data files, temp files, and online logs. It restores new data files that were added to the primary database and recovers the standby database up to the current time.

When you use the `RECOVER STANDBY DATABASE` command to refresh a standby database, you specify either a `FROM SERVICE` clause or a `NOREDO` clause. The `FROM SERVICE` clause specifies the name of a primary service. The `NOREDO` clause specifies that backups should be used for the refresh, which allows a standby to be rolled forward to a specific time or SCN.

The MRP must be manually stopped on the standby before any attempt is made to sync with primary database.

The following is an example of using the `RECOVER STANDBY DATABASE` command. It shows optional usage of the `PFILE` clause to specify a parameter file for the standby database (used when the `spfile` is not available).

```
RECOVER STANDBY DATABASE FROM SERVICE service_name PFILE=pfile_location;
```

### See Also:

- *Oracle Database Backup and Recovery User's Guide* for more information about using the `RECOVER STANDBY DATABASE` command to refresh a physical standby database with changes made to the primary database

## 12.12 RMAN Support for CDBs In an Oracle Data Guard Environment

RMAN supports point-in-time recovery (PITR) of a multitenant container database (CDB) at a standby. (Individual pluggable databases (PDBs) do not have their own individual standbys.)

This is in addition to the support RMAN provides for complete database recovery and complete data file recovery at a standby.

To perform a CDB PITR at a standby, connect to the CDB as root and issue the RMAN `BACKUP`, `RESTORE`, and `RECOVER` commands as necessary.

Be aware that when a CDB PITR is performed on a standby, any pluggable databases (PDBs) that were in a disabled state before the CDB PITR become enabled. To return a PDB to a disabled state, connect to it, ensure it is closed (the `OPEN_MODE` column in the `V$PDBS` view shows a value of `MOUNTED`), and then execute the SQL statement `ALTER PLUGGABLE DATABASE DISABLE RECOVERY`.

The `ALTER PLUGGABLE DATABASE DISABLE RECOVERY` statement takes all data files belonging to the PDB offline and disables recovery for the PDB. The data files that belong to the PDB are not part of any recovery session until the PDB is enabled again. Any new data files created while recovery is disabled are created as unnamed files and are marked offline.

To bring all data files that belong to a PDB back online and enable it for recovery, connect to it, ensure it is closed (the `OPEN_MODE` column in the `V$PDBS` view shows a value of `MOUNTED`), and issue the SQL statement `ALTER PLUGGABLE DATABASE ENABLE RECOVERY`.

To check whether recovery is enabled or disabled on a PDB, query the `V$PDBS` view as follows:

```
SQL> SELECT RECOVERY_STATUS FROM V$PDBS;
```

### Flashing Back a PDB

As of Oracle Database 12c Release 2 (12.2.0.1), you can use the `FLASHBACK PLUGGABLE DATABASE` command (available through SQL or Recovery Manager) to perform a flashback operation on a specific PDB. You can flashback to a specific restore point — an alias for system change number (SCN)— in the past without affecting other PDBs in a CDB. (Performing such an operation on a PDB is analogous to `FLASHBACK DATABASE` in a non-CDB.)

You can also flashback a PDB on a standby. In effect, flashing back a PDB on a standby rewinds the data files for the PDB to a previous point in time, as if restoring a backup of the PDB. Flashing back a PDB on a standby allows the standby to quickly follow the primary after you perform a PDB PITR/flashback operation on the primary, as described in [Actions Needed On a Standby After a PDB PITR On a Primary](#).

#### Note:

Files that are brought online or offline as a result of an `ALTER PLUGGABLE DATABASE [ENABLE | DISABLE]` operation remain in that state even if you flashback the database to a point before the operation was performed.

#### See Also:

- [Actions Needed On a Standby After a PDB PITR On a Primary](#) for information about actions needed on a standby after a PDB PITR on a primary
- [Actions Needed on Standby After TSPITR or Tablespace Plugin at Primary](#) for information about actions needed on a standby after TSPITR or tablespace plugin at the primary

# 13

## Using SQL Apply to Upgrade the Oracle Database

You can use a logical standby database to perform a *rolling upgrade* of Oracle Database software.

During a rolling upgrade, you can run different releases of Oracle Database on the primary and logical standby databases while you upgrade them, one at a time, incurring minimal downtime on the primary database.

For databases originating with the first patch set of Oracle Database 12c Release 1 (12.1), the preferred method for performing a rolling upgrade with an existing physical standby database is to use the `DBMS_ROLLING` PL/SQL package, as described in [Using DBMS\\_ROLLING to Perform a Rolling Upgrade](#) .

The following topics describe how to minimize downtime while upgrading an Oracle database:

- [Benefits of a Rolling Upgrade Using SQL Apply](#)
- [Requirements to Perform a Rolling Upgrade Using SQL Apply](#)
- [Figures and Conventions Used in the Upgrade Instructions](#)
- [Performing a Rolling Upgrade By Creating a New Logical Standby Database](#)
- [Performing a Rolling Upgrade With an Existing Logical Standby Database](#)
- [Performing a Rolling Upgrade With an Existing Physical Standby Database](#)

### Note:

These topics describe an alternative to the usual upgrade procedure involving longer downtime, as described in [Upgrading and Downgrading Databases in an Oracle Data Guard Configuration](#). Do not attempt to combine steps from the two procedures.

### 13.1 Benefits of a Rolling Upgrade Using SQL Apply

These are the advantages of performing a rolling upgrade with SQL Apply.

- Your production database incurs very little downtime. The overall downtime can be as little as the time it takes to perform a switchover.
- You eliminate application downtime due to PL/SQL recompilation.
- You can validate the upgraded database release without affecting the primary database.
- A logical standby accepts archived logs while the upgrade is taking place, which provides an added level of disaster protection.

 **Note:**

- As of Oracle Database 12c Release 1 (12.1), Oracle XML DB Repository supports Oracle Data Guard rolling upgrades. See *Oracle XML DB Developer's Guide* for more information about considerations and restrictions to keep in mind with regard to this support.
- As of Oracle Database 12c Release 1 (12.1), you can upgrade databases that use Oracle Database Vault to new Oracle Database releases and patch sets by using Oracle Data Guard database rolling upgrades with a transient logical standby and the PL/SQL package, `DBMS_ROLLING`.
- As of Oracle Database 12c Release 1 (12.1), you can upgrade databases that use Oracle Label Security (OLS) to new Oracle Database releases and patch sets by using Oracle Data Guard database rolling upgrades using a transient logical standby database and the PL/SQL package, `DBMS_ROLLING`.

## 13.2 Requirements to Perform a Rolling Upgrade Using SQL Apply

These are the requirements for performing a rolling upgrade using SQL Apply.

- If the database is part of an Oracle Data Guard broker configuration, then disable the broker configuration before the rolling upgrade. See *Oracle Data Guard Broker* for information about disabling a broker configuration.
- The Oracle Data Guard protection mode must be set to either maximum availability or maximum performance. Query the `PROTECTION_LEVEL` column in the `V$DATABASE` view to find out the current protection mode setting.
- To ensure the primary database can proceed while the logical standby database is being upgraded, the `LOG_ARCHIVE_DEST_n` initialization parameter for the logical standby database destination must *not* be set to `MANDATORY`.
- The `COMPATIBLE` initialization parameter set on the primary database must match the software release prior to the upgrade. Therefore, a rolling upgrade from release `x` to release `y` requires that the `COMPATIBLE` initialization parameter be set to release `x` on the primary database. The rolling upgrade standby database must have its `COMPATIBLE` initialization parameter set to `x` or higher.

## 13.3 Figures and Conventions Used in the Upgrade Instructions

This background information will help you better understand instructions given for performing upgrades.

**Figure 13-1** shows an Oracle Data Guard configuration before the upgrade begins, with the primary and logical standby databases both running the same Oracle Database software release.

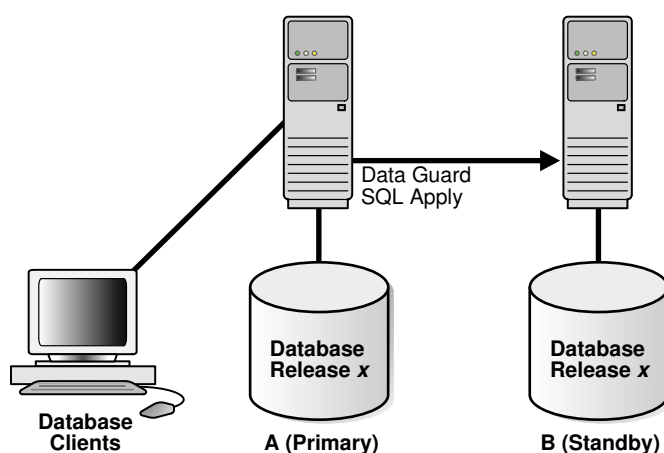
**Figure 13-1 Oracle Data Guard Configuration Before Upgrade**

During the upgrade process, the Oracle Data Guard configuration operates with mixed database releases at several points in this process. Data protection is not available across releases. During these steps, consider having a second standby database in the Oracle Data Guard configuration to provide data protection.

The steps and figures describing the upgrade procedure refer to the databases as Database A and Database B rather than as the primary database and standby database. This is because the databases switch roles during the upgrade procedure. Initially, Database A is the primary database and Database B is the logical standby database, as shown in [Figure 13-1](#).

The following sections describe scenarios in which you can use the SQL Apply rolling upgrade procedure:

- [Performing a Rolling Upgrade By Creating a New Logical Standby Database](#)
- [Performing a Rolling Upgrade With an Existing Logical Standby Database](#)
- [Performing a Rolling Upgrade With an Existing Physical Standby Database](#)

## 13.4 Performing a Rolling Upgrade By Creating a New Logical Standby Database

This scenario assumes you do not have an existing Oracle Data Guard configuration, but you are going to create a logical standby database solely for the purpose of performing a rolling upgrade of the Oracle Database.

[Table 13-1](#) lists the steps to prepare the primary and standby databases for upgrading.

**Table 13-1 Steps to Perform a Rolling Upgrade by Creating a New Logical Standby**

| Step   | Description                                            |
|--------|--------------------------------------------------------|
| Step 1 | Identify unsupported data types and storage attributes |
| Step 2 | Create a logical standby database                      |



**Table 13-1 (Cont.) Steps to Perform a Rolling Upgrade by Creating a New Logical Standby**

| Step   | Description               |
|--------|---------------------------|
| Step 3 | Perform a rolling upgrade |

1. Identify unsupported database objects on the primary database and decide how to handle them by doing the following:

- Review the list of supported data types and storage attributes provided in [Data Type and DDL Support on a Logical Standby Database](#) .
- Query the `DBA_LOGSTDBY_UNSUPPORTED` and `DBA_LOGSTDBY_SKIP` views on the primary database. Changes that are made to the listed tables and schemas on the primary database are not applied on the logical standby database. Use the following query to see a list of unsupported tables:

```
SQL> SELECT DISTINCT OWNER, TABLE_NAME FROM DBA_LOGSTDBY_UNSUPPORTED;
```

Use the following query to see a list of unsupported internal schemas:

```
SQL> SELECT OWNER FROM DBA_LOGSTDBY_SKIP -  
> WHERE STATEMENT_OPT = 'INTERNAL SCHEMA';
```

2. Create a logical standby database, following the instructions in [Creating a Logical Standby Database](#) .

 **Note:**

Before you start SQL Apply for the first time, make sure you capture information about transactions running on the primary database that will not be supported by a logical standby database. Run the following procedures to capture and record the information as events in the `DBA_LOGSTDBY_EVENTS` view:

```
EXECUTE DBMS_LOGSTDBY.APPLY_SET('MAX_EVENTS_RECORDED',  
DBMS_LOGSTDBY.MAX_EVENTS);
```

```
EXECUTE DBMS_LOGSTDBY.APPLY_SET('RECORD_UNSUPPORTED_OPERATIONS',  
'TRUE');
```

Oracle recommends configuring a standby redo log on the logical standby database to minimize downtime.

3. Perform a rolling upgrade now that you have created a logical standby database. Follow the procedure described in [Performing a Rolling Upgrade With an Existing Logical Standby Database](#), which assumes that you have a logical standby running the same Oracle software.

## 13.5 Performing a Rolling Upgrade With an Existing Logical Standby Database

These steps show how to perform a rolling upgrade of Oracle Database on the logical standby database and the primary database.

Table 13-2 lists the steps.

**Table 13-2 Steps to Perform a Rolling Upgrade With an Existing Logical Standby**

| Step    | Description                                                 |
|---------|-------------------------------------------------------------|
| Step 1  | Prepare for rolling upgrade                                 |
| Step 2  | Upgrade the logical standby database                        |
| Step 3  | Restart SQL Apply on the upgraded logical standby database  |
| Step 4  | Monitor events on the upgraded standby database             |
| Step 5  | Begin a switchover                                          |
| Step 6  | Import any tables that were modified during the upgrade     |
| Step 7  | Complete the switchover and activate user applications      |
| Step 8  | Upgrade the old primary database                            |
| Step 9  | Start SQL Apply on the old primary database                 |
| Step 10 | Optionally, raise the compatibility level on both databases |
| Step 11 | Monitor events on the new logical standby database          |
| Step 12 | Optionally, perform another switchover                      |

1. Follow these steps to prepare to perform a rolling upgrade of Oracle Software:
  - a. Stop SQL Apply by issuing the following statement on the logical standby database (Database B):

```
SQL> ALTER DATABASE STOP LOGICAL STANDBY APPLY;
```
  - b. Set compatibility, if needed, to the highest value.

Ensure the `COMPATIBLE` initialization parameter specifies the release number for the Oracle Database software running on the primary database prior to the upgrade.

For example, if the primary database is running release 11.1, then set the `COMPATIBLE` initialization parameter to 11.1 on both databases. Be sure to set the `COMPATIBLE` initialization parameter on the standby database first *before* you set it on the primary database.
2. Upgrade Oracle database software on the logical standby database (Database B) to release *y*. While the logical standby database is being upgraded, it does not accept redo data from the primary database.

To upgrade Oracle Database software, refer to the *Oracle Database Upgrade Guide* for the applicable Oracle Database release.

Figure 13-2 shows Database A running release *x*, and Database B running release *y*. During the upgrade, redo data accumulates on the primary system.

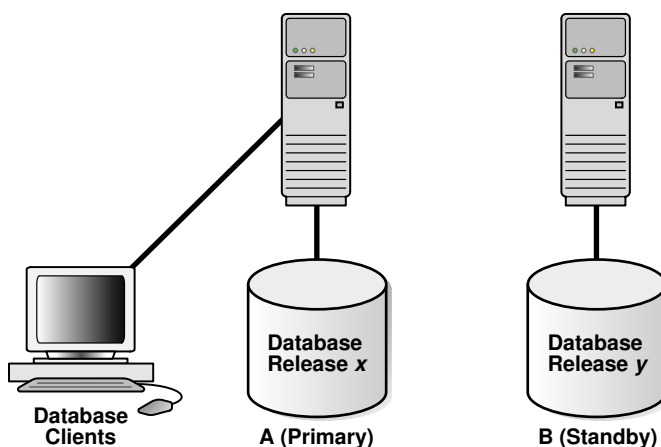
**Figure 13-2 Upgrade the Logical Standby Database Release**

- Restart SQL Apply and operate with release x on Database A and release y on Database B. To start SQL Apply, issue the following statement on Database B:

```
SQL> ALTER DATABASE START LOGICAL STANDBY APPLY IMMEDIATE;
```

The redo data that was accumulating on the primary system is automatically transmitted and applied on the newly upgraded logical standby database. The Oracle Data Guard configuration can run the mixed releases shown in [Figure 13-3](#) for an arbitrary period while you verify that the upgraded Oracle Database software release is running properly in the production environment.

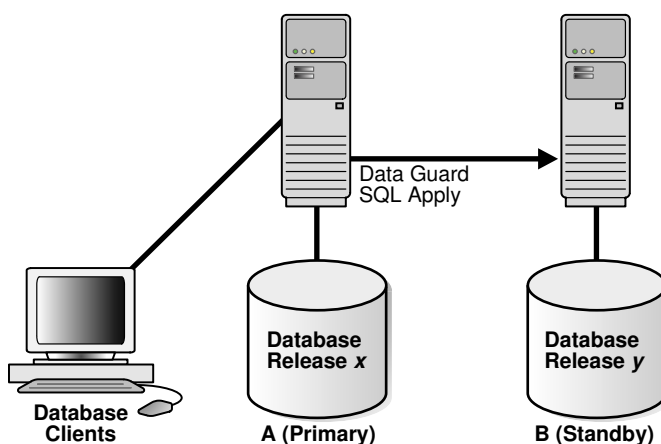
**Figure 13-3 Running Mixed Releases**

To monitor how quickly Database B is catching up to Database A, query the `V$LOGSTDBY_PROGRESS` view on Database B. For example:

```
SQL> ALTER SESSION SET NLS_DATE_FORMAT = 'DD-MON-YY HH24:MI:SS';
Session altered.
```

```
SQL> SELECT SYSDATE, APPLIED_TIME FROM V$LOGSTDBY_PROGRESS;
```

```
SYSDATE          APPLIED_TIME
-----
27-JUN-05 17:07:06 27-JUN-05 17:06:50
```

4. It is recommended that you frequently query the `DBA_LOGSTDBY_EVENTS` view to learn if there are any DDL and DML statements that have not been applied on Database B.

```
SQL> SET LONG 1000
SQL> SET PAGESIZE 180
SQL> SET LINESIZE 79
SQL> SELECT EVENT_TIMESTAMP, EVENT, STATUS FROM DBA_LOGSTDBY_EVENTS -
> ORDER BY EVENT_TIMESTAMP;
```

```
EVENT_TIMESTAMP
```

```
-----
EVENT
-----
---
```

```
STATUS
-----
---
```

```
...
```

```
24-MAY-05 05.18.29.318912 PM
CREATE TABLE SYSTEM.TST (one number)
ORA-16226: DDL skipped due to lack of support
```

```
24-MAY-05 05.18.29.379990 PM
"SYSTEM"."TST"
ORA-16129: unsupported dml encountered
```

In the preceding example:

- The ORA-16226 error shows a DDL statement that could not be supported. In this case, it could not be supported because it belongs to an internal schema.
- The ORA-16129 error shows that a DML statement was not applied.

These types of errors indicate that not all of the changes that occurred on Database A have been applied to Database B. At this point, you must decide whether or not to continue with the upgrade procedure. If you are certain that this difference between the logical standby database and the primary database is acceptable, then continue with the upgrade procedure. If not, discontinue and reinstantiate Database B and perform the upgrade procedure at another time.

5. When you are satisfied that the upgraded database software is operating properly, perform a switchover to reverse the database roles by issuing the following statement on Database A:

```
SQL> ALTER DATABASE COMMIT TO SWITCHOVER TO LOGICAL STANDBY;
```

This statement must wait for existing transactions to complete. To minimize the time it takes to complete the switchover, users still connected to Database A should log off immediately and reconnect to Database B.

 **Note:**

The usual two-phased prepared switchover described in [Performing a Switchover to a Logical Standby Database](#) cannot be used because it requires both primary and standby databases to be running the same version of the Oracle software and at this point, the primary database is running a lower version of the Oracle software. Instead, the single-phased unprepared switchover procedure documented above is used. The unprepared switchover should only be used in the context of a rolling upgrade using a logical standby database.

 **Note:**

If you suspended activity to unsupported tables or packages on Database A when it was the primary database, you must continue to suspend the same activities on Database B while it is the primary database if you eventually plan to switch back to Database A.

6. Step 4 described how to list unsupported tables that are being modified. If unsupported DML statements were issued on the primary database, then import the latest version of those tables using an import utility such as Oracle Data Pump.

For example, the following import command truncates the `scott.emp` table and populates it with data matching the former primary database (A):

```
impdp SYSTEM NETWORK_LINK=databasea TABLES=scott.emp
TABLE_EXISTS_ACTION=TRUNCATE
```

This command prompts you for the `impdp` password before executing.

7. When you are satisfied that the upgraded database software is operating properly, complete the switchover to reverse the database roles:

- a. On Database B, query the `SWITCHOVER_STATUS` column of the `V$DATABASE` view, as follows:

```
SQL> SELECT SWITCHOVER_STATUS FROM V$DATABASE;
```

```
SWITCHOVER_STATUS
-----
TO PRIMARY
```

- b. When the `SWITCHOVER_STATUS` column displays `TO PRIMARY`, complete the switchover by issuing the following statement on Database B:

```
SQL> ALTER DATABASE COMMIT TO SWITCHOVER TO PRIMARY;
```

 **Note:**

The usual two-phased prepared switchover described in [Performing a Switchover to a Logical Standby Database](#) cannot be used because it requires both primary and standby databases to be running the same version of the Oracle software and at this point, the primary database is running a lower version of the Oracle software. Instead, the single-phased unprepared switchover procedure documented above is used. The unprepared switchover should only be used in the context of a rolling upgrade using a logical standby database.

- c. Activate the user applications and services on Database B, which is now running in the primary database role.

After the switchover, you cannot send redo data from the new primary database (B) that is running the new database software release to the new standby database (A) that is running an older software release. This means the following:

- Redo data is accumulating on the new primary database.
- The new primary database is unprotected at this time.

Figure 13-4 shows Database B, the former standby database (running release y), is now the primary database, and Database A, the former primary database (running release x), is now the standby database. The users are connected to Database B.

If Database B can adequately serve as the primary database and your business does not require a logical standby database to support the primary database, then you have completed the rolling upgrade process. Allow users to log in to Database B and begin working there, and discard Database A when it is convenient. Otherwise, continue with Step 8.

**Figure 13-4 After a Switchover**

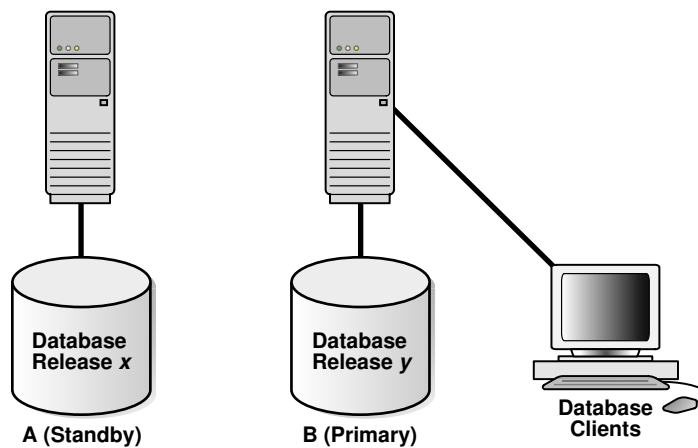

- 8. Database A is still running release x and cannot apply redo data from Database B until you upgrade it and start SQL Apply.

For more information about upgrading Oracle Database software, see the *Oracle Database Upgrade Guide*.

Figure 13-5 shows the system after both databases have been upgraded.

**Figure 13-5 Both Databases Upgraded**

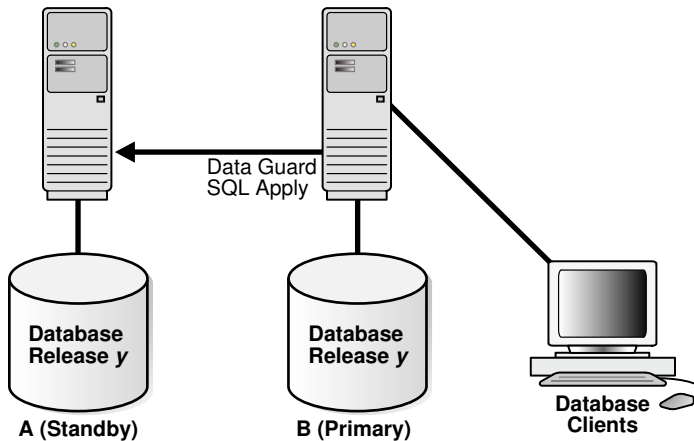

9. Issue the following statement to start SQL Apply on Database A and, if necessary, create a database link to Database B:

```
SQL> ALTER DATABASE START LOGICAL STANDBY APPLY IMMEDIATE NEW PRIMARY db_link_to_b;
```

 **Note:**

You must create a database link (if one has not already been set up) and to use the `NEW PRIMARY` clause, because in Step 4 the single-phased unprepared switchover was used to turn Database A into a standby database.

You must connect as user `SYSTEM` or with an account with a similar level of privileges.

When you start SQL Apply on Database A, the redo data that is accumulating on the primary database (B) is sent to the logical standby database (A). The primary database is protected against data loss once all the redo data is available on the standby database.

10. Raise the compatibility level of both databases by setting the `COMPATIBLE` initialization parameter. You must raise the compatibility level at the logical standby database before you raise it at the primary database. Set the `COMPATIBLE` parameter on the standby database before you set it on the primary database. See *Oracle Database Reference* for more information about the `COMPATIBLE` initialization parameter.
11. To ensure that all changes performed on Database B are properly applied to the logical standby database (A), you should frequently query the `DBA_LOGSTDBY_EVENTS` view, as you did for Database A in step 4.

If changes were made that invalidate Database A as a copy of your existing primary database, you can discard Database A and create a new logical standby database in its place. See [Creating a Logical Standby Database](#) for complete information.

12. Optionally, perform another switchover of the databases so Database A is once again running in the primary database role (as shown in [Figure 13-1](#)).

 **Note:**

You use the two-phased prepared switchover described in [Performing a Switchover to a Logical Standby Database](#) since at this time, both Database A and Database B are running the same version of the Oracle software.

## 13.6 Performing a Rolling Upgrade With an Existing Physical Standby Database

These steps show how to perform a rolling upgrade of Oracle Database software and then get back to your original configuration in which A is the primary database and B is the physical standby database, and both of them are running the upgraded Oracle software.

 **Note:**

These steps assume that you have a primary database (A) and a physical standby database (B) already set up and using Oracle Database release 11.1 or later.

[Table 13-3](#) summarizes the steps involved.

**Table 13-3 Steps to Perform a Rolling Upgrade With an Existing Physical Standby**

| Step   | Description                                                                                                     |
|--------|-----------------------------------------------------------------------------------------------------------------|
| Step 1 | Prepare the primary database for a rolling upgrade (perform these steps on Database A)                          |
| Step 2 | Convert the physical standby database into a logical standby database (perform these steps on Database B)       |
| Step 3 | Upgrade the logical standby database and catch up with the primary database (perform these steps on Database B) |
| Step 4 | Flashback Database A to the guaranteed restore point (perform these steps on Database A)                        |
| Step 5 | Mount Database A using the new version of Oracle software                                                       |
| Step 6 | Convert Database A to a physical standby                                                                        |
| Step 7 | Start managed recovery on Database A                                                                            |
| Step 8 | Perform a switchover to make Database A the primary database                                                    |
| Step 9 | Clean up the guaranteed restore point created in Database A                                                     |



1. Prepare the primary database for a rolling upgrade (perform these steps on Database A)

a. Enable Flashback Database, if it is not already enabled:

```
SQL> SHUTDOWN IMMEDIATE;
SQL> STARTUP MOUNT;
SQL> ALTER DATABASE FLASHBACK ON;
SQL> ALTER DATABASE OPEN;
```

b. Create a guaranteed restore point:

```
SQL> CREATE RESTORE POINT pre_upgrade GUARANTEE FLASHBACK DATABASE;
```

2. Convert the physical standby database into a logical standby database (perform these steps on Database B).

a. Follow the steps outlined in [Creating a Logical Standby Database](#) except for the following difference. In [Convert to a Logical Standby Database](#) you must use a different command to convert the logical standby database. Instead of `ALTER DATABASE RECOVER TO LOGICAL STANDBY db_name`, issue the following command:

```
SQL> ALTER DATABASE RECOVER TO LOGICAL STANDBY KEEP IDENTITY;
SQL> ALTER DATABASE OPEN;
```

b. You must take the following actions before you start SQL Apply for the first time:

i. Disable automatic deletion of foreign archived logs at the logical standby, as follows:

```
SQL> EXECUTE DBMS_LOGSTDBY.APPLY_SET('LOG_AUTO_DELETE', 'FALSE');
```

 **Note:**

Do not delete any remote archived logs processed by the logical standby database (Database B). These remote archived logs are required later during the rolling upgrade process. If you are using the recovery area to store the remote archived logs, you must ensure that it has enough space to accommodate these logs without interfering with the normal operation of the logical standby database.

ii. Make sure you capture information about transactions running on the primary database that will not be supported by a logical standby database. Run the following procedures to capture and record the information as events in the `DBA_LOGSTDBY_EVENTS` table:

```
SQL> EXECUTE DBMS_LOGSTDBY.APPLY_SET('MAX_EVENTS_RECORDED', -
> DBMS_LOGSTDBY.MAX_EVENTS);

SQL> EXECUTE
DBMS_LOGSTDBY.APPLY_SET('RECORD_UNSUPPORTED_OPERATIONS', 'TRUE');
```

iii. Start SQL Apply for the first time, as follows:

```
SQL> ALTER DATABASE START LOGICAL STANDBY APPLY IMMEDIATE;
```

 **See Also:**

- [Customizing Logging of Events in the DBA\\_LOGSTDBY\\_EVENTS View](#) for more information about the DBA\_LOGSTDBY\_EVENTS view
- *Oracle Database PL/SQL Packages and Types Reference* for complete information about the DBMS\_LOGSTDBY package

3. You can now follow Steps 1 through 7 as described in [Performing a Rolling Upgrade With an Existing Logical Standby Database](#) . At the end of these steps, Database B is your primary database running the upgraded version of the Oracle software, and Database A becomes your logical standby database.

Move on to the next step to turn Database A into the physical standby for Database B.

4. Flashback Database A to the guaranteed restore point (perform these steps on Database A).

```
SQL> SHUTDOWN IMMEDIATE;
SQL> STARTUP MOUNT;
SQL> FLASHBACK DATABASE TO RESTORE POINT pre_upgrade;
SQL> SHUTDOWN IMMEDIATE;
```

5. At this point, switch Database A to use the higher version of the Oracle software. You do not run the upgrade scripts, since Database A is turned into a physical standby, and upgraded automatically as it applies the redo data generated by Database B.

Mount Database A, as follows:

```
SQL> STARTUP MOUNT;
```

6. Convert Database A to a physical standby.

```
SQL> ALTER DATABASE CONVERT TO PHYSICAL STANDBY;
SQL> SHUTDOWN IMMEDIATE;
```

7. Start managed recovery on Database A.

Database A is upgraded automatically as it applies the redo data generated by Database B. Managed recovery waits until the new incarnation branch from the primary is registered before it starts applying redo.

```
SQL> STARTUP MOUNT;
SQL> ALTER DATABASE RECOVER MANAGED STANDBY DATABASE -
> DISCONNECT FROM SESSION;
```

 **Note:**

When Redo Apply restarts, it waits for a new incarnation from the current primary database (Database B) to be registered.

8. At this point, Database B is your primary database and Database A is your physical standby, both running the higher version of the Oracle software. To make Database A the primary database, follow the steps described in "[Performing a Switchover to a Physical Standby Database](#)".

9. To preserve disk space, drop the existing guaranteed restore point created in Database A:

```
SQL> DROP RESTORE POINT PRE_UPGRADE;
```

 **See Also:**

The "Database Rolling Upgrade Using Transient Logical Standby: Oracle Data Guard 11g" best practices technical brief available on the Oracle Maximum Availability Architecture (MAA) home page at:

<http://www.oracle.com/goto/maa>

# 14

## Using DBMS\_ROLLING to Perform a Rolling Upgrade

The Rolling Upgrade Using Oracle Active Data Guard feature provides a streamlined method of performing rolling upgrades.

It is implemented using the `DBMS_ROLLING` PL/SQL package, which enables you to upgrade the database software in an Oracle Data Guard configuration in a rolling fashion. The Rolling Upgrade Using Oracle Active Data Guard feature requires a license for the Oracle Active Data Guard option.

You can use this feature to perform database version upgrades starting with the first patchset of Oracle Database 12c. You cannot use it to upgrade from any version earlier than the first Oracle Database 12c patchset. This means that the manual Transient Logical Standby upgrade procedure must still be used when upgrading from Oracle Database 11g to Oracle Database 12c, or when upgrading from the initial Oracle Database 12c release to the first patchset of Oracle Database 12c.

The `DBMS_ROLLING` package performs Oracle Data Guard switchovers to minimize downtime of the primary database service. Prior to using `DBMS_ROLLING`, the Oracle Data Guard environment must be properly configured to accommodate switchovers. The setup requirements differ depending on whether Oracle Data Guard broker is active during execution of `DBMS_ROLLING`:

- If the broker is going to be active during `DBMS_ROLLING`, then see *Oracle Data Guard Broker* for information about setting up the broker for a switchover.
- If the broker is not going to be active during `DBMS_ROLLING`, then see [Role Transitions Involving Logical Standby Databases](#). The absence of Oracle Data Guard broker means that `LOG_ARCHIVE_DEST_n` parameters must be properly configured on the target primary database so that redo shipping resumes after the switchover.

Additionally, you can use this feature immediately for other database maintenance tasks beginning with Oracle Database 12c Release 1 (12.1). The database where maintenance is performed must be operating at a minimum of Oracle 12.1. Such maintenance tasks include:

- Adding partitioning to non-partitioned tables
- Changing BasicFiles LOBs to SecureFiles LOBs
- Changing `XMLType` stored as `CLOB` to `XMLType` stored as binary XML
- Altering tables to be OLTP-compressed

See the following topics:

- [Concepts New to Rolling Upgrades](#)
- [DBMS\\_ROLLING Upgrades and CDBs](#)
- [Overview of Using DBMS\\_ROLLING](#)
- [Planning a Rolling Upgrade](#)

- [Performing a Rolling Upgrade](#)
- [Monitoring a Rolling Upgrade](#)
- [Rolling Back a Rolling Upgrade](#)
- [Handling Role Changes That Occur During a Rolling Upgrade](#)
- [Examples of Rolling Upgrades](#)

## 14.1 Concepts New to Rolling Upgrades

To upgrade the database software in an Oracle Data Guard configuration in a rolling fashion, you first designate a physical standby as the future primary database.

Conceptually, the rolling upgrade process splits the Oracle Data Guard configuration into two groups: the leading group (LG) and the trailing group (TG).

Databases in the leading group are upgraded first; hence the name leading group. The leading group contains the designated future primary database, and the physical standbys that you can configure to protect the designated future primary. The future primary is first converted into a logical standby database and then the new database software is installed on it and the upgrade process is run. Other standby databases in the leading group also must have their software upgraded at this point.

The trailing group contains the original primary database and standby databases that protect the original primary during the rolling upgrade process. While the databases in the leading group are going through the upgrade process, user applications can still be connected to the original primary and making changes. The trailing group databases continue running the old database software until all the databases in the leading group are upgraded and the future primary has caught up with the original primary by applying the changes that were generated at the original primary database during the upgrade window. At this point a switchover is done to transfer the primary role to the designated future primary database, and the user applications are switched over to the new primary database. New software is then installed on the databases that are part of the trailing group, and they are reinstated into the configuration as standbys to the new primary database.

The standbys in the respective groups are called the Leading Group Standbys (LGS) and Trailing Group Standbys (TGS). Other than the designated future primary, all other standbys in the leading group can only be physical standbys. The trailing group can contain both physical and logical standbys; they are called Trailing Group Physical (TGP) and Trailing Group Logical (TGL) in cases where it is necessary to make a distinction between the standby types. The designated future primary is also called the Leading Group Master (LGM) and the original primary database is called the Trailing Group Master (TGM).

The `DBMS_ROLLING` package increases the robustness of the rolling upgrade process as follows:

- It can handle failures during the rolling upgrade process. The original primary or the TGM database can fail. You can initiate a regular failover operation to any other physical standby in the trailing group, and then designate the new primary database as the TGM.
- It allows data protection of the LGM (the designated future primary) during the rolling upgrade process. You can set up physical standbys for the LGM database, and thus protect it during the upgrade process and also achieve Zero Data Loss after the upgrade. After the LGM has been successfully upgraded, a failure in

the LGM can be accommodated by failing over to any of its physical standby databases. You can then designate the failover target database to take over the role of the LGM.

**Table 14-1** compares the characteristics of TGP standbys versus LGP standbys before and after a switchover operation.

**Table 14-1 Trailing Group Physicals (TGP) Versus Leading Group Physicals (LGP)**

| Standby Type                  | Before Switchover                       | After Switchover                        | Notes                                                                                                        |
|-------------------------------|-----------------------------------------|-----------------------------------------|--------------------------------------------------------------------------------------------------------------|
| Trailing Group Physical (TGP) | Low apply lag<br>Lower data loss risk   | High apply lag<br>Higher data loss risk | Can fail over to the primary role<br>Must flash back like the original primary                               |
| Leading Group Physical (LGP)  | High apply lag<br>Higher data loss risk | Low apply lag<br>Lower data loss risk   | Can fail over to the transient logical standby role<br>Does not have to flash back like the original primary |

#### See Also:

- *Oracle Database PL/SQL Packages and Types Reference* for a description of the `DBMS_ROLLING` PL/SQL package
- [Unsupported Tables During Rolling Upgrades](#) for information about how to determine whether any of the tables involved in the upgrade contain data types that are unsupported when performing an upgrade using the `DBMS_ROLLING` PL/SQL package
- [Additional PL/SQL Package Support Available Only in the Context of DBMS\\_ROLLING Upgrades](#) for information about PL/SQL packages that are supported only in the context of a `DBMS_ROLLING` upgrade

### 14.1.1 Data Guard Broker Support for `DBMS_ROLLING` Upgrades

As of Oracle Database 12c Release 2 (12.2.0.1), Data Guard broker can remain on during a `DBMS_ROLLING` rolling upgrade; there is no longer any need to disable it.

Keep the following in mind regarding Data Guard broker support for `DBMS_ROLLING` upgrades:

- Broker support is enabled by default during execution of the `DBMS_ROLLING.BUILD_PLAN` procedure if the broker is enabled at the time of the call. When broker support is enabled, the broker sets up the redo transport destinations as necessary from the original primary database as well as from the rolling upgrade target.
- The fast-start failover feature must be disabled before starting a `DBMS_ROLLING` upgrade.
- Any attempt to enable fast-start failover while a rolling upgrade is in progress is rejected.

- While a rolling upgrade is in progress, role changes are permissible only to the standby databases that are protecting the current primary database. The broker reports the role of the rolling upgrade target as `Transient Logical Standby` during a `SHOW CONFIGURATION` command as well as reporting the configuration status as `ROLLING DATABASE MAINTENANCE IS IN PROGRESS`. If there are standby databases protecting both the original primary and the upgrade target, then this topology is reflected when the `SHOW CONFIGURATION` command is issued from the current primary as well as from the upgrade target (before it has taken over as the primary database).
- The broker prevents a role change to a standby that is not protecting the current primary. This ensures that before the switchover phase, role changes to the Trailing Group Standby are allowed, and after the switchover phase, role changes are only allowed to the Leading Group Standbys.
- During the start of the upgrade process, if the upgrade target is an Oracle RAC database, then the broker automatically reduces the target standby to one instance and allows the upgrade to proceed. Without the broker, the start of the upgrade is rejected if it is found that the target has multiple instances running.
- The broker notifies Oracle Clusterware and Global Data Services as appropriate during the course of the rolling upgrade.
- Although role transitions are typically performed using the broker, the switchover step in a rolling upgrade should continue to be performed using the `DBMS_ROLLING.SWITCHOVER` procedure.
- Information about the status of a rolling upgrade being done using the PL/SQL package `DBMS_ROLLING`, is displayed in the output of the broker commands `SHOW CONFIGURATION` and `SHOW DATABASE`.

The `SHOW CONFIGURATION` command shows `Transient logical standby database` as the role of the upgrade target, and `ROLLING DATABASE MAINTENANCE IN PROGRESS` as the configuration status. An example of this output is as follows:

```
Configuration - DRSolution

Protection Mode: MaxPerformance
Members:
North_Sales - Primary database
South_Sales - Transient logical standby database

Fast-Start Failover: DISABLED

Configuration Status:
ROLLING DATABASE MAINTENANCE IN PROGRESS
```

The `SHOW DATABASE` command shows a `WARNING` with an appropriate `ORA` error for the upgrade target and the trailing or leading standbys, depending on the current rolling upgrade progress. An example of this output is as follows:

```
Database - South_Sales

Role: Physical standby database
Intended State: APPLY-ON
Transport Lag: ***
Apply Lag: ***
```

```
Average Apply Rate: ***
Real Time Query: OFF
Instance(s):
  South
Database Warning(s):
  ORA-16866: database converted to transient logical standby
database for rolling
database maintenance
Database Status:
WARNING
```

 **See Also:**

- DBMS\_ROLLING
- SHOW CONFIGURATION
- SHOW DATABASE

## 14.2 DBMS\_ROLLING Upgrades and CDBs

The steps to performing a rolling upgrade using `DBMS_ROLLING` on a multitenant container database (CDB) are no different from non-CDB environments, but there are additional requirements and considerations.

### Requirements Specific to DBMS\_ROLLING Upgrades on a CDB

The additional requirements when you use `DBMS_ROLLING` to perform a rolling upgrade on a CDB are as follows.

- The TNS services referenced in the `LOG_ARCHIVE_DEST_n` parameters must be services that resolve to the root container of the destination database. The process assisting `DBMS_ROLLING` performs numerous operations which can only execute from the root container.
- All container databases on the transient logical standby must be plugged in and opened prior to calling `DBMS_ROLLING.SWITCHOVER`. This eliminates the possibility that the logical standby apply engine will halt because it cannot apply to a given PDB.

See [Example 14-5](#) for an example rolling upgrade using `DBMS_ROLLING`.

### Additional Considerations for DBMS\_ROLLING Upgrades on a CDB

Installing, upgrading, or patching of applications installed in application containers is not supported while a `DBMS_ROLLING` upgrade is in progress.

- If DDL is executed to start the install, upgrade, or patching of an application container while a `DBMS_ROLLING` upgrade is in progress, then an error is returned. (The `DBMS_ROLLING` upgrade continues.)
- If an upgrade to an application container is in progress, then an attempt to start a `DBMS_ROLLING` upgrade results in an error. (The application container upgrade continues.)



- If a DBMS\_ROLLING upgrade is performed and database compatibility is set to 12.2 or higher, then replication of application containers is supported. Except for DBMS\_ROLLING upgrades, logical standby does not offer any support for application containers; such containers are skipped and a message is written to the alert log indicating that application containers are being skipped.
- The CDB that you are upgrading using DBMS\_ROLLING can contain pluggable databases (PDBs) with different character sets.

## 14.3 Overview of Using DBMS\_ROLLING

There are three stages to the rolling upgrade process using the DBMS\_ROLLING PL/SQL Package: specification, compilation, and execution.

1. **Specification:** You first specify how you want to implement the rolling upgrade process. It is mandatory that you designate a future primary database. This act conceptually creates the leading and the trailing groups. At this point, the leading group only contains the LGM. You can optionally specify other standbys to protect the LGM.

You use the following procedures during the specification phase:

- DBMS\_ROLLING.INIT\_PLAN
- DBMS\_ROLLING.SET\_PARAMETER

2. **Compilation:** This is initiated by calling the DBMS\_ROLLING.BUILD\_PLAN procedure. The BUILD\_PLAN procedure communicates with all databases participating in the rolling upgrade and assembles a rolling upgrade plan. The BUILD\_PLAN procedure is also called to alter an existing rolling upgrade plan. Alterations are necessary after changes to DBMS\_ROLLING parameters and after changes to the topology as a result of failover. All participating databases must be reachable during execution of the BUILD\_PLAN procedure because numerous validations are required to ensure a successful rolling upgrade.

3. **Execution:** Execution of the rolling upgrade has five stages.

**Stage 1:** The DBMS\_ROLLING.START\_PLAN procedure starts the execution of the rolling upgrade. This converts the LGM database to a logical standby and starts the SQL Apply process at the LGM.

**Stage 2:** You upgrade the database software at the databases that are part of the leading group. You also run the upgrade scripts at the LGM. After this is done, you must restart SQL Apply processes at the LGM database. (See *Oracle Database Upgrade Guide* for information about upgrade scripts.) Leading group physical standbys are also addressed during this stage by re-mounting them using the higher version binaries. These databases are upgraded via recovery of the redo from the LGM.

**Stage 3:** After the apply lag reaches a given threshold (set to 10 minutes by default, but can be configured during the specification stage), the DBMS\_ROLLING.SWITCHOVER procedure proceeds with the switchover operation. When the switchover is complete, the LGM becomes the primary database.

**Stage 4:** The LGM is now the primary database running the new database software and the databases in the leading group are protecting it. The TGM is mounted and the databases in the trailing group are still running the older version of the database software. You must prepare the TGM and TGS databases for upgrade by upgrading the database software and re-mounting the databases on

the higher version binaries. (See *Oracle Database Upgrade Guide* for information about upgrade scripts.)

**Stage 5:** Execute the `DBMS_ROLLING.FINISH_PLAN` procedure at the current primary database (originally the LGM). It reinstates all the databases in the trailing group to become the standbys of the current primary database, and restarts the apply processes. The `FINISH_PLAN` procedure waits for all databases in the trailing group to be upgraded to the new release (although the database software for the trailing group databases was changed in Stage 4, the data dictionary of the trailing group databases, except for any logical standbys in the trailing group, are updated based on media recovery of the redo generated during the upgrade at the LGM database).

After the rolling upgrade has been successfully executed, you can remove your rolling upgrade specification by calling the `DBMS_ROLLING.DESTROY_PLAN` procedure.

## 14.4 Planning a Rolling Upgrade

Planning your rolling upgrade is essential to a successful upgrade experience. In the planning phase you specify various upgrade parameters and build an upgrade plan.

The parameters and upgrade plan forecast all the operational details unique to your environment. The upgrade plan performs site-specific validations to alert you to configuration and resource problems which could potentially disrupt the rolling upgrade.

The tasks necessary to define upgrade parameters and build an upgrade plan are as follows:

- Initialize the upgrade parameters
- View the current upgrade parameter values
- Modify the upgrade parameter values, as necessary
- Build the upgrade plan
- View the current upgrade plan
- Revise the upgrade plan, as necessary

The rest of this section describes each of these steps in detail. They must be performed in the order presented.

1. Plan parameters must be initialized to system-generated default values before they can be customized. To initialize plan parameters, call the `DBMS_ROLLING.INIT_PLAN` procedure. This procedure identifies the `DB_UNIQUE_NAME` of the future primary database (the leading group master or LGM). The LGM is converted into a logical standby database as part of the `START_PLAN` procedure call. The following is a sample call to the `INIT_PLAN` procedure in which `boston` is identified as the future primary database:

```
DBMS_ROLLING.INIT_PLAN(future_primary=>'boston');
```

The `INIT_PLAN` procedure returns an initial set of system-generated plan parameters. It adds each physical and logical standby database specified in the `DG_CONFIG init.ora` parameter as a participant in the rolling upgrade. Other databases (such as downstream databases serving GoldenGate downstream deployment or snapshot standbys) are excluded automatically.

By default, standby databases other than the future primary are configured to protect the primary database, and are configured as mandatory participants in the rolling upgrade.

Once the database-related parameters have been defined, the `INIT_PLAN` procedure defines operational parameters with system-supplied defaults. In most cases, the plan parameters are ready for plan validation, but to ensure they meet your needs, be sure to review each parameter.

Plan parameters are persisted in the database until you call the `DESTROY_PLAN` procedure to remove all states related to the rolling upgrade.

- After the `INIT_PLAN` procedure has completed, you can query the `DBA_ROLLING_PARAMETERS` view to see the plan parameters and their current values. Plan parameters are either global or local in scope. Global parameters are attributes of the rolling upgrade as a whole and are independent of the database participants. Global parameters have a `NULL` value in the `SCOPE` column. Local parameters have a specific database name in the `SCOPE` column, with which they are associated. The following is a sample query:

```
SQL> select scope, name, curval from dba_rolling_parameters order
by scope, name;
```

| SCOPE   | NAME                        | CURVAL                  |
|---------|-----------------------------|-------------------------|
| seattle | INVOLVEMENT                 | FULL                    |
| seattle | MEMBER                      | NONE                    |
| boston  | INVOLVEMENT                 | FULL                    |
| boston  | MEMBER                      | TRAILING                |
| oakland | INVOLVEMENT                 | FULL                    |
| oakland | MEMBER                      | TRAILING                |
| atlanta | INVOLVEMENT                 | FULL                    |
| atlanta | MEMBER                      | LEADING                 |
|         | ACTIVE_SESSIONS_TIMEOUT     | 3600                    |
|         | ACTIVE_SESSIONS_WAIT        | 0                       |
|         | BACKUP_CONTROLFILE          | rolling_change_backup.f |
|         | DGBROKER                    | 0                       |
|         | DICTIONARY_LOAD_TIMEOUT     | 3600                    |
|         | DICTIONARY_LOAD_WAIT        | 0                       |
|         | DICTIONARY_PLS_WAIT_INIT    | 300                     |
|         | DICTIONARY_PLS_WAIT_TIMEOUT | 3600                    |
|         | EVENT_RECORDS               | 10000                   |
|         | FAILOVER                    | 0                       |
|         | GRP_PREFIX                  | DBMSRU_                 |
|         | IGNORE_BUILD_WARNINGS       | 0                       |
|         | IGNORE_LAST_ERROR           | 0                       |
|         | LAD_ENABLED_TIMEOUT         | 600                     |
|         | LOG_LEVEL                   | INFO                    |
|         | READY_LGM_LAG_TIME          | 600                     |
|         | READY_LGM_LAG_TIMEOUT       | 60                      |
|         | READY_LGM_LAG_WAIT          | 0                       |
|         | SWITCH_LGM_LAG_TIME         | 600                     |
|         | SWITCH_LGM_LAG_TIMEOUT      | 60                      |
|         | SWITCH_LGM_LAG_WAIT         | 1                       |
|         | SWITCH_LGS_LAG_TIME         | 60                      |

|                        |       |
|------------------------|-------|
| SWITCH_LGS_LAG_TIMEOUT | 60    |
| SWITCH_LGS_LAG_WAIT    | 0     |
| UPDATED_LGS_TIMEOUT    | 10800 |
| UPDATED_LGS_WAIT       | 1     |
| UPDATED_TGS_TIMEOUT    | 10800 |
| UPDATED_TGS_WAIT       | 1     |

35 rows selected.

In the sample output, the databases atlanta, boston, oakland, and seattle were all discovered through the DG\_CONFIG, and assigned parameters in the current plan.

#### See Also:

- *Oracle Database Reference* for more information about the DBA\_ROLLING\_PARAMETERS view

3. To modify any existing rolling upgrade parameter, use the DBMS\_ROLLING.SET\_PARAMETER PL/SQL procedure. The following is an example of using the SET\_PARAMETER procedure:

```
DBMS_ROLLING.SET_PARAMETER(
  scope IN VARCHAR2,
  name IN VARCHAR2,
  value IN VARCHAR2);
```

The scope identifies either a DB\_UNIQUE\_NAME value for local parameters or NULL for global parameters. It is not necessary to provide a scope of NULL for parameters that are not specific to a database.

The name is the name of the parameter to modify.

The value identifies the value for the specified parameter. A value of NULL reverts the parameter back to its system-supplied default if one exists.

#### See Also:

- *Oracle Database PL/SQL Packages and Types Reference* for a complete list of all available rolling upgrade parameters

The following examples illustrate sample usage of some rolling upgrade parameters.

4. After all the necessary parameters are specified, you build an upgrade plan. An upgrade plan is a custom generated set of instructions which guides your Oracle Data Guard configuration through a rolling upgrade. (The plan that is generated differs based on whether or not the configuration is managed by Data Guard broker.)

To build an upgrade plan, use the DBA\_ROLLING.BUILD\_PLAN PL/SQL procedure. This procedure requires the configuration to be exactly as described by the plan parameters with all of the instances started and reachable through the network.

The procedure is called as follows:

```
DBMS_ROLLING.BUILD_PLAN;
```

There are no arguments to specify because the procedure gets all its input from the `DBA_ROLLING_PARAMETERS` view. The procedure validates plan parameters and performs site-specific validations of resources such as log transport and flash recovery area settings. In general, configuration settings that do not meet the criteria of best-practice values are treated as warnings and recorded in the `DBA_ROLLING_EVENTS` view. By default, the `IGNORE_BUILD_WARNINGS` parameter is set to 1, meaning warnings do not prevent an upgrade plan from reaching a usable state. You can set this parameter to 0 for stricter rule enforcement when plans are built.

 **Note:**

The validations performed during plan generation are specific to rolling upgrades. They are not a substitute for the recommended practice of running the Pre-Upgrade Information Tool to evaluate upgrade readiness.

After generating the plan, move on to the following steps to view it, diagnose any problems with it, and revise it if necessary.

5. After the `BUILD_PLAN` procedure successfully returns, the complete upgrade plan is viewable in the `DBA_ROLLING_PLAN` view. Each record in the view identifies a specific instruction that is scheduled for execution.

The following output is an example of how a rolling upgrade plan would appear:

```
SQL> SELECT instid, target, phase, description FROM DBA_ROLLING_PLAN;
```

| INSTID | TARGET  | PHASE | DESCRIPTION                                           |
|--------|---------|-------|-------------------------------------------------------|
| 1      | seattle | START | Verify database is a primary                          |
| 2      | seattle | START | Verify MAXIMUM PROTECTION is disabled                 |
| 3      | boston  | START | Verify database is a physical standby                 |
| 4      | boston  | START | Verify physical standby is mounted                    |
| 5      | oakland | START | Verify database is a physical standby                 |
| 6      | oakland | START | Verify physical standby is mounted                    |
| 7      | atlanta | START | Verify database is a physical standby                 |
| 8      | atlanta | START | Verify physical standby is mounted                    |
| 9      | seattle | START | Verify server parameter file exists and is modifiable |
| 10     | boston  | START | Verify server parameter file exists and is modifiable |
| 11     | oakland | START | Verify server parameter file exists and is modifiable |
| 12     | atlanta | START | Verify server parameter file exists and is modifiable |
| 13     | seattle | START | Verify Data Guard Broker configuration is disabled    |
| 14     | boston  | START | Verify Data Guard Broker configuration is disabled    |
| 15     | oakland | START | Verify Data Guard Broker configuration is disabled    |
| 16     | atlanta | START | Verify Data Guard Broker configuration is disabled    |
| 17     | seattle | START | Verify flashback database is enabled                  |
| 18     | seattle | START | Verify available flashback restore points             |
| 19     | boston  | START | Verify flashback database is enabled                  |
| 20     | boston  | START | Verify available flashback restore points             |
| 21     | oakland | START | Verify flashback database is enabled                  |
| 22     | oakland | START | Verify available flashback restore points             |
| 23     | atlanta | START | Verify flashback database is enabled                  |

```

24 atlanta      START  Verify available flashback restore points
25 boston      START  Scan LADs for presence of atlanta destination
26 boston      START  Test if atlanta is reachable using configured TNS service
27 boston      START  Stop media recovery
28 oakland     START  Stop media recovery
29 atlanta     START  Stop media recovery
30 boston      START  Drop guaranteed restore point DBMSRU_INITIAL
31 boston      START  Create guaranteed restore point DBMSRU_INITIAL
32 oakland     START  Drop guaranteed restore point DBMSRU_INITIAL
33 oakland     START  Create guaranteed restore point DBMSRU_INITIAL
34 atlanta     START  Drop guaranteed restore point DBMSRU_INITIAL
35 atlanta     START  Create guaranteed restore point DBMSRU_INITIAL
36 seattle     START  Drop guaranteed restore point DBMSRU_INITIAL
37 seattle     START  Create guaranteed restore point DBMSRU_INITIAL

```

| INSTID | TARGET  | PHASE  | DESCRIPTION                                                        |
|--------|---------|--------|--------------------------------------------------------------------|
| 38     | boston  | START  | Start media recovery                                               |
| 39     | boston  | START  | Verify media recovery is running                                   |
| 40     | oakland | START  | Start media recovery                                               |
| 41     | oakland | START  | Verify media recovery is running                                   |
| 42     | atlanta | START  | Start media recovery                                               |
| 43     | atlanta | START  | Verify media recovery is running                                   |
| 44     | seattle | START  | Verify user_dump_dest has been specified                           |
| 45     | seattle | START  | Backup control file to rolling_change_backup.f                     |
| 46     | boston  | START  | Verify user_dump_dest has been specified                           |
| 47     | boston  | START  | Backup control file to rolling_change_backup.f                     |
| 48     | oakland | START  | Verify user_dump_dest has been specified                           |
| 49     | oakland | START  | Backup control file to rolling_change_backup.f                     |
| 50     | atlanta | START  | Verify user_dump_dest has been specified                           |
| 51     | atlanta | START  | Backup control file to rolling_change_backup.f                     |
| 52     | seattle | START  | Get current redo branch of the primary database                    |
| 53     | boston  | START  | Wait until recovery is active on the primary's redo branch         |
| 54     | boston  | START  | Stop media recovery                                                |
| 55     | seattle | START  | Execute dbms_logstdby.build                                        |
| 56     | boston  | START  | Convert into a transient logical standby                           |
| 57     | boston  | START  | Open database                                                      |
| 58     | boston  | START  | Configure logical standby parameters                               |
| 59     | boston  | START  | Start logical standby apply                                        |
| 60     | boston  | START  | Get redo branch of transient logical standby                       |
| 61     | boston  | START  | Get reset scn of transient logical redo branch                     |
| 62     | atlanta | START  | Stop media recovery                                                |
| 63     | atlanta | START  | Flashback database                                                 |
| 64     | seattle | START  | Disable log file archival to atlanta                               |
| 65     | boston  | START  | Enable log file archival to atlanta                                |
| 66     | boston  | START  | Wait for log archive destination to atlanta to reach a valid state |
| 67     | atlanta | START  | Wait until transient logical redo branch has been registered       |
| 68     | atlanta | START  | Start media recovery                                               |
| 69     | atlanta | START  | Wait until v\$dataguard_stats has been initialized                 |
| 70     | atlanta | START  | Wait until recovery has started on the transient redo branch       |
| 71     | seattle | START  | Log pre-switchover instructions to events table                    |
| 72     | boston  | START  | Record start of user upgrade of boston                             |
| 73     | boston  | SWITCH | Verify database is in OPENRW mode                                  |
| 74     | boston  | SWITCH | Record completion of user upgrade of boston                        |
| 75     | boston  | SWITCH | Scan LADs for presence of seattle destination                      |
| 76     | boston  | SWITCH | Scan LADs for presence of oakland destination                      |
| 77     | boston  | SWITCH | Scan LADs for presence of atlanta destination                      |

|        |         |        |                                                               |
|--------|---------|--------|---------------------------------------------------------------|
| 78     | boston  | SWITCH | Test if seattle is reachable using configured TNS service     |
| 79     | boston  | SWITCH | Test if oakland is reachable using configured TNS service     |
| 80     | boston  | SWITCH | Test if atlanta is reachable using configured TNS service     |
| 81     | seattle | SWITCH | Enable log file archival to boston                            |
| 82     | boston  | SWITCH | Enable log file archival to atlanta                           |
| 83     | boston  | SWITCH | Start logical standby apply                                   |
| 84     | atlanta | SWITCH | Start media recovery                                          |
| 85     | atlanta | SWITCH | Wait until upgrade redo has been fully recovered              |
| 86     | boston  | SWITCH | Wait until apply lag has fallen below 600 seconds             |
| 87     | seattle | SWITCH | Log post-switchover instructions to events table              |
| 88     | seattle | SWITCH | Switch database to a logical standby                          |
| 89     | boston  | SWITCH | Wait until end-of-redo has been applied                       |
| 90     | oakland | SWITCH | Wait until end-of-redo has been applied                       |
| 91     | seattle | SWITCH | Disable log file archival to oakland                          |
| 92     | boston  | SWITCH | Switch database to a primary                                  |
| 93     | oakland | SWITCH | Stop media recovery                                           |
| 94     | seattle | SWITCH | Synchronize plan with new primary                             |
| 95     | seattle | FINISH | Verify only a single instance is active                       |
| 96     | seattle | FINISH | Verify database is mounted                                    |
| 97     | seattle | FINISH | Flashback database                                            |
| 98     | seattle | FINISH | Convert into a physical standby                               |
| 99     | oakland | FINISH | Verify database is mounted                                    |
| 100    | oakland | FINISH | Flashback database                                            |
| 101    | boston  | FINISH | Verify database is open                                       |
| 102    | boston  | FINISH | Save the DBID of the new primary                              |
| 103    | boston  | FINISH | Save the logminer session start scn                           |
| 104    | seattle | FINISH | Wait until transient logical redo branch has been registered  |
| 105    | oakland | FINISH | Wait until transient logical redo branch has been registered  |
| 106    | seattle | FINISH | Start media recovery                                          |
| 107    | oakland | FINISH | Start media recovery                                          |
| 108    | seattle | FINISH | Wait until apply/recovery has started on the transient branch |
| 109    | oakland | FINISH | Wait until apply/recovery has started on the transient branch |
| 110    | seattle | FINISH | Wait until upgrade redo has been fully recovered              |
| -----  |         |        |                                                               |
| INSTID | TARGET  | PHASE  | DESCRIPTION                                                   |
| -----  |         |        |                                                               |
| 111    | oakland | FINISH | Wait until upgrade redo has been fully recovered              |
| 112    | seattle | FINISH | Drop guaranteed restore point DBMSRU_INITIAL                  |
| 113    | boston  | FINISH | Drop guaranteed restore point DBMSRU_INITIAL                  |
| 114    | oakland | FINISH | Drop guaranteed restore point DBMSRU_INITIAL                  |
| 115    | atlanta | FINISH | Drop guaranteed restore point DBMSRU_INITIAL                  |

115 rows selected.

SQL>

The columns in this view display the following information:

- **INSTID** - The Instruction ID, which is the order in which the instruction is to be performed. Instructions are typically performed in groups.
- **PHASE** - Every instruction in the upgrade plan is associated with a particular phase. A phase is a logical grouping of instructions which is performed by a procedure in the `DBMS_ROLLING` PL/SQL package. When a `DBMS_ROLLING` procedure is invoked, all of the associated instructions in the upgrade plan for that phase are executed. Possible phases are as follows:
  - **START**: Consists of activities related to setup such as taking restore points, instantiation of the transient logical standby database, and configuration of LGS databases. Activities in this phase are initiated when you call the

DBMS\_ROLLING.START\_PLAN procedure. See Step 1 in "[Performing a Rolling Upgrade](#)".

- SWITCH: Consists of activities related to the switchover of the transient logical standby into the new primary database. Activities in this phase are initiated when you call the DBMS\_ROLLING.SWITCHOVER procedure. See Step 3 in "[Performing a Rolling Upgrade](#)".
  - FINISH: Consists of activities related to configuring standby databases for recovery of the upgrade redo. Activities in this phase are initiated when you call the DBMS\_ROLLING.FINISH\_PLAN procedure. See Step 5 in "[Performing a Rolling Upgrade](#)".
- EXEC\_STATUS - The overall status of the instruction.
  - PROGRESS - The progress of an instruction's execution. A value of REQUESTING indicates an instruction is being transmitted to a target database for execution. A value of EXECUTING indicates the instruction is actively being executed. A value of REPLYING indicates completion information is being returned.
  - DESCRIPTION - The specific operation that is scheduled to be performed.
  - TARGET - The site at which a given instruction is to be performed.
  - EXEC\_INFO - Additional contextual information related to the instruction.

#### See Also:

- *Oracle Database Reference* for more information about the DBA\_ROLLING\_PLAN view

6. Upgrade plans need to be revised after any change to the rolling upgrade or database configuration. A configuration change could include any of the following:
  - init.ora parameter file changes at any of the databases participating in the rolling upgrade
  - database role changes as a result of failover events
  - rolling upgrade parameter changes

To revise an active upgrade plan, call the BUILD\_PLAN procedure again. In some cases, the BUILD\_PLAN procedure may raise an error if a given change cannot be accepted. For example, setting the ACTIVE\_SESSIONS\_WAIT parameter has no effect if the switchover has already occurred.

It is recommended that you call the BUILD\_PLAN procedure to process a group of parameter changes rather than processing parameters individually.

#### **Example 14-1 Setting Switchover to Enforce Apply Lag Requirements**

The following example demonstrates how to configure the plan to wait for the apply lag to fall below 60 seconds before switching over to the future primary:

```
DBMS_ROLLING.SET_PARAMETER('SWITCH_LGM_LAG_WAIT', '1');
DBMS_ROLLING.SET_PARAMETER('SWITCH_LGM_LAG_TIME', '60');
```



**Example 14-2 Resetting Logging Back to Its Default Value**

The following example demonstrates resetting the `LOG_LEVEL` global parameter back to its default value.

```
DBMS_ROLLING.SET_PARAMETER (
  name=>'LOG_LEVEL',
  value=>NULL);
```

**Example 14-3 Designating a Database as an Optional Participant**

The following example demonstrates setting the `INVOLVEMENT` local parameter of database `atlanta` to indicate that errors encountered on the database should not impede the overall rolling upgrade.

```
DBMS_ROLLING.SET_PARAMETER (
  scope=>'atlanta',
  name=>'involvement',
  value=>'optional');
```

**Example 14-4 Setting a Database to Protect the Transient Logical Standby**

The following example demonstrates setting the `MEMBER` local parameter of database `atlanta` to indicate it should protect the transient logical standby database during the rolling upgrade.

```
DBMS_ROLLING.SET_PARAMETER (
  scope=>'atlanta',
  name=>'member',
  value=>'leading');
```

## 14.5 Performing a Rolling Upgrade

Follow these steps to perform a rolling upgrade using the `DBMS_ROLLING` PL/SQL package.

[Table 14-2](#) provides a summary of the steps. These steps assume that you have first successfully built an upgrade plan as described in "[Planning a Rolling Upgrade](#)".

**Table 14-2 Steps to Perform Rolling Upgrade Using `DBMS_ROLLING`**

| Step   | Description                                                                                                                                                                                      | PHASE             |
|--------|--------------------------------------------------------------------------------------------------------------------------------------------------------------------------------------------------|-------------------|
| Step 1 | Call the <code>DBMS_ROLLING.START_PLAN</code> procedure to configure the future primary and physical standbys designated to protect the future primary.                                          | START             |
| Step 2 | Manually upgrade the Oracle Database software at the future primary database and standbys that protect it.                                                                                       | SWITCH<br>PENDING |
| Step 3 | Call the <code>DBMS_ROLLING.SWITCHOVER</code> procedure to switch roles between the current and future primary database.                                                                         | SWITCH            |
| Step 4 | Manually restart the former primary and remaining standby databases on the higher version of Oracle Database.                                                                                    | FINISH<br>PENDING |
| Step 5 | Call the <code>DBMS_ROLLING.FINISH_PLAN</code> procedure to convert the former primary to a physical standby, and to configure the remaining standby databases for recovery of the upgrade redo. | FINISH            |

Activities that take place during each step belong to a specific phase of the rolling upgrade as shown in the PHASE column of [Table 14-2](#). A rolling upgrade operation is at a single phase at any given time. The current phase of a rolling upgrade is reported in the PHASE column of the `DBA_ROLLING_STATUS` view.

The rest of this section describes each of the upgrade steps in detail.

1. Call the `DBMS_ROLLING.START_PLAN` procedure to configure the future primary and physical standbys designated to protect the future primary.

The `DBMS_ROLLING.START_PLAN` procedure is the formal start of the rolling upgrade. The goal of the `START_PLAN` procedure is to configure the transient logical standby database and any physical standby databases that have been designated to protect it. When invoked, the `START_PLAN` procedure executes all instructions in the upgrade plan with a PHASE value of `START_PLAN`. The types of instructions that are performed include:

- Backing up the control file for each database to a trace file
- Creating flashback database guaranteed restore points
- Building a LogMiner dictionary at the primary database
- Recovering the designated physical standby into a transient logical standby database
- Loading the LogMiner dictionary into the logical standby database
- Configuring LGS databases with the transient logical standby database

Call the `START_PLAN` procedure as follows (no arguments are required):

```
SQL> EXECUTE DBMS_ROLLING.START_PLAN;
```

2. Manually upgrade the Oracle Database software at the future primary database and standbys that protect it.

After the `START_PLAN` procedure has completed, you must manually upgrade the Oracle Database software at the future primary database and standbys which protect the future primary database. This involves the following steps:

- a. Upgrade the Oracle Database software of the transient logical (LGM) and leading group standbys (LGS).
- b. Start media recovery on the LGS databases.
- c. Upgrade the transient logical standby database either manually or using the Database Upgrade Assistant (DBUA).
- d. Re-open the transient logical standby in read/write mode.

The transient logical standby and LGS databases are a functional group. The LGS databases must be restarted on the higher version actively running media recovery before the transient logical standby is upgraded. If the LGS databases are not configured first, then the upgrade of the transient logical is not protected. At the conclusion of this step, the upgrade of the transient logical is complete, and media recovery is running on all LGS databases.

It is recommended that you wait until all LGS databases have been fully upgraded before performing the switchover. An LGS database is fully upgraded when its associated record in the `DBA_ROLLING_DATABASES` view reports a value of `YES` in the `UPDATED` column.

3. Call the `DBMS_ROLLING.SWITCHOVER` procedure to switch roles between the current and future primary database.

The `SWITCHOVER` procedure switches roles between the current and future primary databases. The procedure times the switchover to occur when apply lag is minimal which minimizes outage time of the primary service. The `SWITCHOVER` procedure executes all instructions in the upgrade plan with a `PHASE` value of `SWITCHOVER`.

The types of instructions that are performed can include:

- Waiting for the apply lag at the Leading Group Master (LGM), which is currently the transient logical standby, to fall below a threshold value
- Waiting for the apply lag at LGS databases to fall below a threshold value
- Switching the primary to the logical standby role
- Switching the Leading Group Master (LGM), which is currently a logical standby, to the primary role
- Enabling log archive destinations at the Leading Group Master (LGM) after it has become the new primary

Call the `SWITCHOVER` procedure as follows (no arguments are required):

```
SQL> EXECUTE DBMS_ROLLING.SWITCHOVER;
```

If a switchover error occurs after the switchover of the primary to the standby role but before the transient logical could be successfully converted into the primary role, then continue to execute the `SWITCHOVER` procedure at the former primary site until successful completion.

4. At this point, you must manually restart and mount the former primary and remaining standby databases on the higher version of Oracle Database. Mounting the standby databases is especially important because the `DBMS_ROLLING` package needs to communicate with the standby database to continue the rolling upgrade.
5. The overall goal of the `FINISH_PLAN` procedure is to configure the former primary and TGP standbys as physical standbys which recover through the upgrade redo. When invoked, the `FINISH_PLAN` procedure executes all instructions in the upgrade plan with a `PHASE` value of `FINISH`. The types of instructions that are performed include:
  - Flashback of the former primary and TGP standbys
  - Conversion of the former primary into a physical standby
  - Startup of media recovery on the new redo branch

Call the `FINISH_PLAN` procedure as follows (no arguments are required):

```
SQL> EXECUTE DBMS_ROLLING.FINISH_PLAN;
```

## 14.6 Monitoring a Rolling Upgrade

There are several views you can query for information about the databases involved in a rolling upgrade.

- `DBA_ROLLING_STATUS`  
Provides information about the overall status of the upgrade.
- `DBA_ROLLING_DATABASES`

Provides information about the role, protection, and recovery state of each database involved in the rolling upgrade.

- `DBA_ROLLING_STATISTICS`

Provides statistics such as start and finish times, how long services were offline, and so on.

#### See Also:

- *Oracle Database Reference* for descriptions of these views

## 14.7 Rolling Back a Rolling Upgrade

To roll back a rolling upgrade procedure, you can call the `DBMS_ROLLING.ROLLBACK_PLAN` procedure.

The procedure is called as follows:

```
DBMS_ROLLING.ROLLBACK_PLAN;
```

The `ROLLBACK_PLAN` procedure has the following requirements:

- The `ROLLBACK_PLAN` procedure can only be called if the `DBMS_ROLLING.SWITCHOVER` procedure has not been previously called.
- Before you can use the `ROLLBACK_PLAN` procedure you must set the transient logical standby database back to a mounted state because a flashback database is imminent.
- If the Oracle Database software was already upgraded, then you must restart the resultant physical standbys on the older version, and start media recovery.

## 14.8 Handling Role Changes That Occur During a Rolling Upgrade

If a situation arises in which a rolling upgrade is underway and you need to perform a failover in your Oracle Data Guard configuration before the rollover completes, you can do so only in these circumstances.

- The failover was not performed while a `DBMS_ROLLING` procedure was in progress.
- The failover was between a primary database and a physical standby database, and was a no-data-loss failover.
- The failover was between a transient logical standby database and a physical standby of the transient logical standby database.

A role change is a significant event that inevitably invalidates instructions in the upgrade plan, which was tailored for a different configuration. To resume the rolling upgrade, a new plan must be created. You must set the `FAILOVER` parameter to indicate that the configuration has changed. This parameter is detected on the next invocation of the `BUILD_PLAN` procedure, and the existing plan is amended accordingly.

After the revised plan is built, you can resume the rolling upgrade.

## 14.9 Examples of Rolling Upgrades

These examples show a variety of rolling upgrade scenarios.

At some point in all of the scenarios, the same basic rolling upgrade steps are used. These steps are shown in [Example 14-5](#). The rest of the examples refer back to this example where appropriate rather than reiterating the same steps.

Some of the examples in this section instruct you to resume the rolling upgrade, which means that you should continue where you left off. Resuming a rolling upgrade involves identifying the current phase of the rolling upgrade and reperforming either the PL/SQL procedure associated with the phase or the activities relevant to the phase. The current phase of the rolling upgrade is shown in the `PHASE` column of the `DBA_ROLLING_STATUS` view.

### Note:

The scenarios provided in this section are only meant to be hypothetical examples. You can use the Rolling Upgrade Using Oracle Active Data Guard feature to perform database upgrades beginning with the first Oracle Database 12c patchset.

### Example 14-5 Basic Rolling Upgrade Steps

1. Start the rolling upgrade:  

```
SQL> EXECUTE DBMS_ROLLING.START_PLAN;
```
2. Upgrade the transient logical standby and its protecting standbys.
  - a. Mount LGP standbys using the higher Oracle Database software version.
  - b. Start media recovery on Leading Group Physicals (LGP).
  - c. Open the Leading Group Master (LGM), which is the transient logical standby, in upgrade mode using the higher Oracle Database software version.
  - d. Upgrade the Leading Group Master (LGM), which is the transient logical standby, either manually or using the Database Upgrade Assistant (DBUA).
  - e. Restart the Leading Group Master (LGM), which is the transient logical standby, in read/write mode.
3. Switchover to the Leading Group Master (LGM):  

```
SQL> EXECUTE DBMS_ROLLING.SWITCHOVER;
```
4. Restart the databases in the trailing group. This includes the original primary database and all its protecting standbys in the trailing group (TGP).
  - a. Mount the former primary using the higher Oracle Database version.
  - b. Mount the physical standbys of the former primary using the higher Oracle Database version.
5. Finish the rolling upgrade:  

```
SQL> EXECUTE DBMS_ROLLING.FINISH_PLAN;
```

### Example 14-6 Rolling Upgrade Between Two Databases

The following example demonstrates a rolling upgrade on a two-site configuration consisting of a primary database and a physical standby database. In this example, `seattle` is the current primary and `boston` is the future primary. The `seattle` database is automatically chosen as the Trailing Group Master (TGM) and participates in the operation. By default, there is nothing that needs to be set for `seattle`.

1. Initialize the upgrade plan:

```
SQL> EXECUTE DBMS_ROLLING.INIT_PLAN(future_primary=>'boston');
```

2. Build the upgrade plan:

```
SQL> EXECUTE DBMS_ROLLING.BUILD_PLAN;
```

3. Perform the rolling upgrade as described in [Example 14-5](#).

### Example 14-7 Rolling Upgrade Between Three Databases

The following example demonstrates a rolling upgrade on a three-site configuration consisting of a primary databases and two physical standby databases. In this example, `seattle` is the primary, `boston` is the future primary, and `oakland` is a physical standby of `seattle`.

1. Initialize the upgrade plan:

```
SQL> EXECUTE DBMS_ROLLING.INIT_PLAN (future_primary => 'boston');
```

2. Build the upgrade plan:

```
SQL> EXECUTE DBMS_ROLLING.BUILD_PLAN;
```

3. Perform the rolling upgrade as described in [Example 14-5](#).

### Example 14-8 Rolling Upgrade Between Four Databases

The following example demonstrates a rolling upgrade on a four-site configuration consisting of a primary database and three physical standby databases. In this example, `seattle` is the primary database, `boston` is the future primary, `oakland` is a physical standby of `seattle`, and `atlanta` is a physical standby of `boston`.

1. Initialize the upgrade plan:

```
SQL> EXECUTE DBMS_ROLLING.INIT_PLAN (future_primary => 'boston');
```

2. Configure `atlanta` as a standby in the leading group:

```
SQL> EXECUTE DBMS_ROLLING.SET_PARAMETER(scope=>'atlanta',name=>'member',  
value=>'leading');
```

3. Build the upgrade plan:

```
SQL> EXECUTE DBMS_ROLLING.BUILD_PLAN;
```

4. Perform the rolling upgrade as described in [Example 14-5](#).

### Example 14-9 Rolling Upgrade on a Reader Farm

The following example demonstrates a rolling upgrade on a reader farm configuration consisting of one primary database and nine physical standby databases. In this example, eight physical standby databases are split into two groups of four in order for physical standbys to be available as Oracle Active Data Guard standbys before and after the switchover. In this example, `seattle` is the primary, `boston` is the future primary, databases `rf[a-d]` are physical standbys of `seattle`, and databases `rf[e-h]` are physical standbys of `boston`. The rolling upgrade is configured so that the

switchover to the new primary waits until the apply lag among the reader farm group of the future primary database is less than 60 seconds.

1. Initialize the upgrade plan:

```
SQL> EXECUTE DBMS_ROLLING.INIT_PLAN ( future_primary => 'boston');
```

2. Configure the reader farm group to protect the future primary:

```
SQL> EXECUTE DBMS_ROLLING.SET_PARAMETER(scope=>'rfe',name=>'member',  
value=>'leading');
```

```
SQL> EXECUTE DBMS_ROLLING.SET_PARAMETER(scope=>'rff',name=>'member',  
value=>'leading');
```

```
SQL> EXECUTE DBMS_ROLLING.SET_PARAMETER(scope=>'rfg',name=>'member',  
value=>'leading');
```

```
SQL> EXECUTE DBMS_ROLLING.SET_PARAMETER(scope=>'rfh',name=>'member',  
value=>'leading');
```

3. Set a maximum permitted apply lag of 60 seconds on the future primary's reader farm:

```
SQL> EXECUTE DBMS_ROLLING.SET_PARAMETER(name=>'SWITCH_LGS_LAG_WAIT',  
value=>'1');
```

4. Build the upgrade plan:

```
SQL> EXECUTE DBMS_ROLLING.BUILD_PLAN;
```

5. Perform the rolling upgrade as described in [Example 14-5](#).

### Example 14-10 Rolling Upgrade for Application Testing

The following example demonstrates using rolling upgrade on a four-site configuration to configure a transient logical standby and a physical standby of the transient logical standby in order to validate an application on the higher version database. The primary database is `seattle`, `boston` is the future primary, `oakland` is a physical standby of `seattle`, and `atlanta` is physical standby of `boston`. So in this example, `seattle` and `oakland` make up the trailing group, and `boston` and `atlanta` make up the leading group. At the end of testing, `boston` and `atlanta` are restored back to their original physical standby roles in order to resume protection of `seattle`.

1. Initialize the upgrade plan:

```
SQL> EXECUTE DBMS_ROLLING.INIT_PLAN (future_primary => 'boston');
```

2. Configure atlanta to protect the future primary:

```
SQL> EXECUTE DBMS_ROLLING.SET_PARAMETER(scope=>'atlanta',name=>'member',  
value=>'leading');
```

3. Build the upgrade plan:

```
SQL> EXECUTE DBMS_ROLLING.BUILD_PLAN;
```

4. Start the rolling upgrade:

```
SQL> EXECUTE DBMS_ROLLING.START_PLAN;
```

5. Upgrade boston and atlanta:

- a. Mount atlanta using the higher database version.
- b. Start media recovery on atlanta.

- c. Open `boston` in upgrade mode using the higher database version.
  - d. Upgrade database `boston` either manually or using the Database Upgrade Assistant (DBUA).
  - e. Restart `boston` in read/write mode.
6. Test the application, as necessary.
7. Rollback the configuration:
  - a. Restart `boston` in mounted mode
  - b. Roll back the upgrade:

```
SQL> EXECUTE DBMS_ROLLING.ROLLBACK_PLAN;
```
8. Start media recovery on `boston` and `atlanta` using the older database version:
  - a. Mount `boston` and `atlanta` using the lower database version.
  - b. Start media recovery on `boston` and `atlanta`.

#### Example 14-11 Resuming a Rolling Upgrade After a Failover to a New Primary

The following example demonstrates a no-data-loss failover of a physical standby to the primary role followed by the reconfiguration of the rolling upgrade plan on a three-site configuration. In this example, `seattle` is the primary, `boston` is the future primary, and `oakland` is a physical standby of `seattle`. Database `oakland` is failed over to become the new primary. (The Trailing Group is (`seattle`, `oakland`) and the Leading Group is `boston`.)

1. Recover remaining redo on `oakland`, and fail over to the new primary role:

```
SQL> ALTER DATABASE RECOVER MANAGED STANDBY DATABASE CANCEL;  
SQL> ALTER DATABASE RECOVER MANAGED STANDBY FINISH;  
SQL> ALTER DATABASE FAILOVER TO OAKLAND;  
SQL> ALTER DATABASE OPEN;
```

2. Configure log archive destinations on `oakland`, as necessary:

```
SQL> ALTER SYSTEM SET LOG_ARCHIVE_DEST_2='service="boston" reopen=5  
2 LGWR ASYNC NET_TIMEOUT=180 valid_for=(ONLINE_LOGFILE,  
PRIMARY_ROLE)  
3 DB_UNIQUE_NAME="oakland" ';
```

```
SQL> ALTER SYSTEM ARCHIVE LOG CURRENT;
```

3. Set a parameter to indicate that a failover took place:

```
SQL> EXECUTE DBMS_ROLLING.SET_PARAMETER(name=>'failover', value=>'1');
```

4. Revise the upgrade plan:

```
SQL> EXECUTE DBMS_ROLLING.BUILD_PLAN;
```

5. Resume the rolling upgrade.



**Example 14-12 Resuming a Rolling Upgrade After a Failover to a New Transient Logical**

The following example demonstrates a failover of a physical standby to the transient logical role, followed by the reconfiguration of the rolling upgrade plan on a five-site configuration. In this example, `seattle` is the primary, `boston` is the future primary, `oakland` is a physical standby of `seattle`, and `atlanta` and `miami` are physical standbys of `boston`. Database `atlanta` is failed over to become the new transient logical standby.

1. Recover remaining redo on `atlanta` and failover to the new transient logical role:

```
SQL> ALTER DATABASE RECOVER MANAGED STANDBY FINISH;
```

```
SQL> ALTER DATABASE ACTIVATE STANDBY DATABASE;
```

```
SQL> ALTER DATABASE OPEN;
```

2. Configure log archive destinations on `atlanta`, as necessary:

```
SQL> alter system set log_archive_dest_2='service="seattle" reopen=5
  2 LGWR ASYNC NET_TIMEOUT=180 valid_for=(ONLINE_LOGFILE, PRIMARY_ROLE)
  3 DB_UNIQUE_NAME="atlanta"';
```

```
SQL> alter system set log_archive_dest_3='service="oakland" reopen=5
  2 LGWR ASYNC NET_TIMEOUT=180 valid_for=(ONLINE_LOGFILE, PRIMARY_ROLE)
  3 DB_UNIQUE_NAME="atlanta"';
```

```
SQL> alter system set log_archive_dest_4='service="miami" reopen=5
  2 LGWR ASYNC NET_TIMEOUT=180 valid_for=(ONLINE_LOGFILE, ALL_ROLES)
  3 DB_UNIQUE_NAME="atlanta"';
```

3. Specify `atlanta` as the new transient logical standby database:

```
SQL> EXECUTE DBMS_ROLLING.SET_PARAMETER(name=>'failover', value=>'1');
```

4. Revise the upgrade plan:

```
SQL> EXECUTE DBMS_ROLLING.BUILD_PLAN;
```

5. Resume the rolling upgrade.

# 15

## Oracle Data Guard Scenarios

These scenarios present different situations you might encounter while administering your Oracle Data Guard configuration. Each of them can be adapted to your specific environment.

- [Configuring Logical Standby Databases After a Failover](#)
- [Converting a Failed Primary Into a Standby Database Using Flashback Database](#)
- [Using Flashback Database After Issuing an Open Resetlogs Statement](#)
- [Recovering After the NOLOGGING Clause Is Specified](#)
- [Creating a Standby Database That Uses OMF or Oracle ASM](#)
- [Recovering From Lost-Write Errors on a Primary Database](#)
- [Using the DBCOMP Procedure to Detect Lost Writes and Other Inconsistencies](#)
- [Converting a Failed Primary into a Standby Database Using RMAN Backups](#)
- [Changing the Character Set of a Primary Without Re-Creating Physical Standbys](#)
- [Actions Needed On a Standby After a PDB PITR or PDB Flashback On a Primary](#)

### 15.1 Configuring Logical Standby Databases After a Failover

These are the steps required on a logical standby database after the primary database has failed over to another standby database.

After a failover has occurred, a logical standby database cannot act as a standby database for the new primary database until it has applied the final redo from the original primary database. This is similar to the way the new primary database applied the final redo during the failover. The steps you must perform depend on whether the new primary database was a physical standby or a logical standby database prior to the failover:

- [When the New Primary Database Was Formerly a Physical Standby Database](#)
- [When the New Primary Database Was Formerly a Logical Standby Database](#)

#### 15.1.1 When the New Primary Database Was Formerly a Physical Standby Database

These steps demonstrate how to configure a logical standby database to support a new primary database that was a physical standby database before it assumed the primary role.

In this scenario, SAT is the logical standby database and NYC is the primary database.

1. On the SAT database, issue the following statement to configure the FAL\_SERVER parameter to enable automatic recovery of log files.

```
SQL> ALTER SYSTEM SET FAL_SERVER='<tns_name_to_new_primary>';
SQL> ALTER SYSTEM SET FAL_CLIENT='<tns_name_to_local_database>';
```

2. Call the PREPARE\_FOR\_NEW\_PRIMARY routine to verify that the logical standby database is capable of serving as a standby database to the new primary database. During this step, local copies of log files that pose a risk for data divergence are deleted from the local database. These log files are then requested for re-archival directly from the new primary database.

On the SAT database, issue the following statement:

```
SQL> EXECUTE DBMS_LOGSTDBY.PREPARE_FOR_NEW_PRIMARY( -
> former_standby_type => 'PHYSICAL' -
> dblink => 'nyc_link');
```

 **Note:**

If the ORA-16109 message is returned and the 'LOGSTDBY: prepare\_for\_new\_primary failure -- applied too far, flashback required.' warning is written in the alert.log, perform the following steps:

- a. Flash back the database to the SCN as stated in the warning and then
- b. Repeat this step before continuing.

See [Flashing Back a Logical Standby Database to a Specific Applied SCN](#) for an example of how to flash back a logical standby database to an Apply SCN.

3. On the SAT database, issue the following statement to start SQL Apply:

```
SQL> ALTER DATABASE START LOGICAL STANDBY APPLY IMMEDIATE;
```

## 15.1.2 When the New Primary Database Was Formerly a Logical Standby Database

These steps demonstrate how to configure a logical standby database to support a new primary database that was a logical standby database before it assumed the primary role.

In this scenario, SAT is the logical standby database and NYC is the primary database.

1. Ensure the new primary database is ready to support logical standby databases. On the NYC database, ensure the following query returns a value of NONE.

Otherwise the new primary database has not completed the work required to enable support for logical standby databases. For example:

```
SQL> SELECT PENDING_ROLE_CHANGE_TASKS FROM V$DATABASE;
```

A value of `NONE` must be returned before you attempt to reinstate an old primary database.

2. On the SAT database, issue the following statement to configure the `FAL_SERVER` parameter to enable automatic recover of log files:

```
SQL> ALTER SYSTEM SET FAL_SERVER='<tns_name_to_new_primary>';  
SQL> ALTER SYSTEM SET FAL_CLIENT='<tns_name_to_local_database>';
```

3. Call the `PREPARE_FOR_NEW_PRIMARY` routine to verify the logical standby database is capable of being a standby to the new primary. During this step, local copies of log files which pose a risk for data divergence are deleted from the local database. These log files are then requested for re-archival directly from the new primary database.

On the SAT database, issue the following statement:

```
SQL> EXECUTE DBMS_LOGSTDBY.PREPARE_FOR_NEW_PRIMARY( -  
> former_standby_type => 'LOGICAL' -  
> dblink => 'nyc_link');
```

 **Note:**

If the `ORA-16109` message is returned and the `LOGSTDBY: prepare_for_new_primary failure -- applied too far, flashback required warning` is written in the `alert.log` file, perform the following steps:

- a. Flash back the database to the SCN as stated in the warning and then
- b. Repeat this step before continuing.

See [Flashing Back a Logical Standby Database to a Specific Applied SCN](#) for an example of how to flash back a logical standby database to an Apply SCN.

4. On the SAT database, issue the following statements to start SQL Apply:

```
SQL> ALTER DATABASE START LOGICAL STANDBY APPLY NEW PRIMARY  
nyc_link;
```

This statement must always be issued without the real-time apply option enabled. To enable real-time apply on the logical standby database, wait for the above statement to complete successfully, and then issue the following statements:

```
SQL> ALTER DATABASE STOP LOGICAL STANDBY APPLY;  
SQL> ALTER DATABASE START LOGICAL STANDBY APPLY IMMEDIATE;
```

## 15.2 Converting a Failed Primary Into a Standby Database Using Flashback Database

After a failover occurs, the original primary database can no longer participate in the Oracle Data Guard configuration until it is repaired and established as a standby database in the new configuration.

To do this, you can use the Flashback Database feature to recover the failed primary database to a point in time before the failover occurred, and then convert it into a physical or logical standby database in the new configuration. The following sections describe:

- [Flashing Back a Failed Primary Database into a Physical Standby Database](#)
- [Flashing Back a Failed Primary Database into a Logical Standby Database](#)

### Note:

You must have already enabled Flashback Database on the original primary database before the failover. See *Oracle Database Backup and Recovery User's Guide* for more information.

- [Flashing Back a Logical Standby Database to a Specific Applied SCN](#)

### See Also:

*Oracle Data Guard Broker* for information about automatic reinstatement of the failed primary database as a new standby database (as an alternative to using Flashback Database)

### 15.2.1 Flashing Back a Failed Primary Database into a Physical Standby Database

These steps bring the old primary database back into the Oracle Data Guard configuration as a physical standby database.

The following steps assume that a failover has been performed to a physical standby database and that Flashback Database was enabled on the old primary database at the time of the failover.

1. On the new primary database, issue the following query to determine the SCN at which the old standby database became the new primary database:

```
SQL> SELECT TO_CHAR(STANDBY_BECAME_PRIMARY_SCN) FROM V$DATABASE;
```

2. Shut down the old primary database (if necessary), mount it, and flash it back to the value for STANDBY\_BECAME\_PRIMARY\_SCN that was determined in the previous step.

```
SQL> SHUTDOWN IMMEDIATE;
SQL> STARTUP MOUNT;
SQL> FLASHBACK DATABASE TO SCN standby_became_primary_scn;
```

3. To convert the database to a physical standby database, issue the following statement on the old primary database:

```
SQL> ALTER DATABASE CONVERT TO PHYSICAL STANDBY;
```

4. To start transporting redo to the new physical standby database, perform the following steps on the new primary database:

- a. Issue the following query to see the current state of the archive destinations:

```
SQL> SELECT DEST_ID, DEST_NAME, STATUS, PROTECTION_MODE, DESTINATION, -
> ERROR,SRL FROM V$ARCHIVE_DEST_STATUS;
```

- b. If necessary, enable the destination:

```
SQL> ALTER SYSTEM SET LOG_ARCHIVE_DEST_1=ENABLE;
```

- c. Perform a log switch to ensure the standby database begins receiving redo data from the new primary database, and verify it was sent successfully. Issue the following SQL statements on the new primary database:

```
SQL> ALTER SYSTEM SWITCH LOGFILE;
SQL> SELECT DEST_ID, DEST_NAME, STATUS, PROTECTION_MODE, DESTINATION, -
> ERROR,SRL FROM V$ARCHIVE_DEST_STATUS;
```

On the new standby database, you may also need to change the LOG\_ARCHIVE\_DEST\_1 initialization parameters so that redo transport services do not transmit redo data to other databases.

5. Start Redo Apply on the new physical standby database:

```
SQL> ALTER DATABASE RECOVER MANAGED STANDBY DATABASE DISCONNECT;
```

Redo Apply automatically stops each time it encounters a redo record that is generated as the result of a role transition, so Redo Apply needs to be restarted one or more times until it has applied beyond the SCN at which the new primary database became the primary database. Once the failed primary database is restored and is running in the standby role, you can optionally perform a switchover to transition the databases to their original (pre-failure) roles. See "[Performing a Switchover to a Physical Standby Database](#)" for more information.

## 15.2.2 Flashing Back a Failed Primary Database into a Logical Standby Database

These steps bring the old primary database back into the Oracle Data Guard configuration as a new logical standby database without having to formally instantiate it from the new primary database.

These steps assume that the Oracle Data Guard configuration has already completed a failover involving a logical standby database and that Flashback Database has been enabled on the old primary database.

1. Determine the flashback SCN and the recovery SCN. The flashback SCN is the SCN to which the failed primary database is flashed back. The recovery SCN is the SCN to which the failed primary database is recovered. Issue the following query on the new primary to identify these SCNs:

```
SQL> SELECT merge_change# AS FLASHBACK_SCN, processed_change# AS
RECOVERY_SCN -
> FROM DBA_LOGSTDBY_HISTORY -
> WHERE stream_sequence# = (SELECT MAX(stream_sequence#)-1 -
> FROM DBA_LOGSTDBY_HISTORY);
```

2. Flash back the failed primary database to the flashback SCN identified in the previous step:

```
SQL> FLASHBACK DATABASE TO SCN flashback_scn;
```

3. Convert the failed primary into a physical standby, and remount the standby database in preparation for recovery:

```
SQL> ALTER DATABASE CONVERT TO PHYSICAL STANDBY;
```

4. Configure the `FAL_SERVER` parameter to enable automatic recovery of log files. Issue the following statement on the physical standby (failed primary):

```
SQL> ALTER SYSTEM SET FAL_SERVER='<tns_name_to_new_primary>';
```

5. Remove any archive logs created at the time of or, after the failover operation, from the failed primary database. If the failed primary database was isolated from the standby, it could have divergent archive logs that are not consistent with the current primary database. To ensure these divergent archive logs are never applied, they must be deleted from backups and the fast recovery area. You can use the following RMAN command to delete the relevant archive logs from the fast recovery area:

```
RMAN> DELETE FORCE ARCHIVELOG FROM SCN FLASHBACK_SCN;
```

Once deleted, these divergent logs and subsequent transactions can never be recovered.

6. Recover until the recovery SCN identified in Step 1:

```
SQL> RECOVER MANAGED STANDBY DATABASE UNTIL CHANGE recovery_scn;
```

7. Enable the database guard:

```
SQL> ALTER DATABASE GUARD ALL;
```

8. Activate the physical standby to become a primary database:

```
SQL> ALTER DATABASE ACTIVATE STANDBY DATABASE;
```

9. Open the database:

```
SQL> ALTER DATABASE OPEN;
```

10. Create a database link to the new primary, and start SQL Apply:

```
SQL> CREATE PUBLIC DATABASE LINK mylink -
> CONNECT TO system IDENTIFIED BY password -
> USING 'service_name_of_new_primary_database';
```

```
SQL> ALTER DATABASE START LOGICAL STANDBY APPLY NEW PRIMARY mylink;
```

The role reversal is now complete.

## 15.2.3 Flashing Back a Logical Standby Database to a Specific Applied SCN

One of the benefits of a standby database is that Flashback Database can be performed on the standby database without affecting the primary database service. Flashing back a database to a specific point in time is a straightforward task, however on a logical standby database, you may want to flash back to a time just before a known transaction was committed. Such a need can arise when configuring a logical standby database with a new primary database after a failover. These steps describe how to use Flashback Database and SQL Apply to recover to a known applied SCN.

1. Once you have determined the known SCN at the primary (APPLIED\_SCN), issue the following query to determine the corresponding SCN at the logical standby database, to use for the flashback operation:

```
SQL> SELECT DBMS_LOGSTDBY.MAP_PRIMARY_SCN (PRIMARY_SCN => APPLIED_SCN) -  
> AS TARGET_SCN FROM DUAL;
```

2. Issue the following SQL statements to flash back the logical standby database to the specified SCN, and open the logical standby database with the RESETLOGS option:

```
SQL> SHUTDOWN;  
SQL> STARTUP MOUNT EXCLUSIVE;  
SQL> FLASHBACK DATABASE TO SCN <TARGET_SCN>;  
SQL> ALTER DATABASE OPEN RESETLOGS;
```

3. Issue the following query to confirm SQL Apply has applied less than or up to the APPLIED\_SCN.

```
SQL> SELECT APPLIED_SCN FROM V$LOGSTDBY_PROGRESS;
```

## 15.3 Using Flashback Database After Issuing an Open Resetlogs Statement

If an error occurs on the primary database in an Oracle Data Guard configuration in which the standby database is using real-time apply, then the same error is applied on the standby database. If Flashback Database is enabled, you can revert the primary and standby databases back to their pre-error condition.

To do so, issue the `FLASHBACK DATABASE` and `OPEN RESETLOGS` statements on the primary database, and then issuing a similar `FLASHBACK STANDBY DATABASE` statement on the standby database before restarting apply services. (If Flashback Database is not enabled, you need to re-create the standby database, as described in [Creating a Physical Standby Database](#) and [Creating a Logical Standby Database](#), after the point-in-time recovery was performed on the primary database.)

### 15.3.1 Flashing Back a Physical Standby Database to a Specific Point-in-Time

These steps describe how to avoid re-creating a physical standby database after you issue the `OPEN RESETLOGS` statement on the primary database.



With Oracle Database Release 19c, if the standby is in mount mode and flashback database is enabled, you may not need to do anything. In the common case, if there is sufficient flashback data available, the standby is automatically flashed back so that the standby continues to follow the primary.

If the standby is open and flashback database is enabled, you can place the standby in mount mode and then start standby recovery. The MRP, in an attempt to let the standby follow the primary, triggers an automatic flashback of the standby. If this operation succeeds, as reported in the alert log, you need to follow up with opening the Active Data Guard instance.

If automatic flashback is not triggered, or automatic flashback did not result in the standby following the primary, you can perform the steps described in this section.

1. Determine the SCN before the RESETLOGS operation occurred. For example, on the primary database, use the following query to obtain the value of the system change number (SCN) that is 2 SCNs before the RESETLOGS operation occurred on the primary database:

```
SQL> SELECT TO_CHAR(RESETLOGS_CHANGE# - 2) FROM V$DATABASE;
```

2. On the standby database, obtain the current SCN with the following query:

```
SQL> SELECT TO_CHAR(CURRENT_SCN) FROM V$DATABASE;
```

3. If the value of CURRENT\_SCN is larger than the value of resetlogs\_change# - 2, issue the following statement to flash back the standby database.

```
SQL> FLASHBACK STANDBY DATABASE TO SCN resetlogs_change# -2;
```

- If the value of CURRENT\_SCN is less than the value of the resetlogs\_change# - 2, skip to Step 4.
  - If the standby database's SCN is far enough behind the primary database's SCN, and the new branch of redo from the OPEN RESETLOGS statement has been registered at the standby, then apply services can continue through the OPEN RESETLOGS statement without stopping. In this case, flashing back the database is unnecessary because apply services do not stop upon reaching the OPEN RESETLOGS statement in the redo data.
4. To start Redo Apply on the physical standby database, issue the following statement:

```
SQL> ALTER DATABASE RECOVER MANAGED STANDBY DATABASE DISCONNECT;
```

The standby database is now ready to receive and apply redo from the primary database.

## 15.3.2 Flashing Back a Logical Standby Database to a Specific Point-in-Time

These steps describe how to avoid re-creating a logical standby database after you have flashed back the primary database and opened it by issuing an OPEN RESETLOGS statement.

 **Note:**

If SQL Apply detects the occurrence of a `resetlogs` operation at the primary database, it automatically mines the correct branch of redo, if it is possible to do so without having to flashback the logical standby database. Otherwise, SQL Apply stops with an error `ORA-1346: LogMiner processed redo beyond specified reset log scn`. In this section, it is assumed that SQL Apply has already stopped with such an error.

1. On the primary database, use the following query to obtain the value of the system change number (SCN) that is 2 SCNs before the `RESETLOGS` operation occurred on the primary database:

```
SQL> SELECT TO_CHAR(RESETLOGS_CHANGE# - 2) AS FLASHBACK_SCN FROM V$DATABASE;
```

2. Determine the target SCN for flashback operation at the logical standby.

In this step, the `FLASHBACK_SCN` value for `PRIMARY_SCN` is from Step 1.

```
SQL> SELECT DBMS_LOGSTDBY.MAP_PRIMARY_SCN (PRIMARY_SCN => FLASHBACK_SCN) -  
> AS TARGET_SCN FROM DUAL;
```

3. Issue the following SQL statements to flash back the logical standby database to the specified SCN, and open the logical standby database with the `RESETLOGS` option:

```
SQL> SHUTDOWN;  
SQL> STARTUP MOUNT EXCLUSIVE;  
SQL> FLASHBACK DATABASE TO SCN <TARGET_SCN>;  
SQL> ALTER DATABASE OPEN RESETLOGS;
```

4. Confirm that a log file from the primary's new branch is registered before SQL apply is started. Issue the following query on the primary database:

```
SQL> SELECT resetlogs_id FROM V$DATABASE_INCARNATION WHERE status =  
'CURRENT';
```

Issue the following query on the standby database:

```
SQL> SELECT * FROM DBA_LOGSTDBY_LOG WHERE resetlogs_id =  
resetlogs_id_at_primary;
```

If one or more rows are returned, it confirms that there are registered logfiles from the primary's new branch.

5. Start SQL Apply:

```
SQL> ALTER DATABASE START LOGICAL STANDBY APPLY IMMEDIATE;
```

## 15.4 Recovering After the NOLOGGING Clause Is Specified

Some SQL statements allow you to specify a `NOLOGGING` clause so that the operation is not logged in the online redo log file.

In actuality, a redo record is still written to the online redo log file, but there is no data associated with the record. This can result in log application or data access errors at the standby site and manual recovery might be required to resume applying log files.

Depending on whether you have a logical standby or physical standby, you can avoid these errors by doing the following:

- Logical standbys — specify the `FORCE LOGGING` clause in the `CREATE DATABASE` or `ALTER DATABASE` statements.
- Physical standbys — specify a logging mode that is appropriate to the way in which you plan to use your Data Guard configuration, as described in [Enable an Appropriate Logging Mode](#).

You can see the current logging mode in the `V$DATABASE.FORCE_LOGGING` column (for CDBs) or the `DBA_PDBS.FORCE_LOGGING` column (for PDBs).

## 15.4.1 Recovery Steps for Logical Standby Databases

On logical standby databases, when SQL Apply encounters a redo record for an operation performed with the `NOLOGGING` clause on a table that is not being skipped, it stops with the following error:

```
ORA-16211 unsupported record found in the archived redo log
```

To recover after the `NOLOGGING` clause is specified, re-create one or more tables from the primary database, as described in [Adding or Re-Creating Tables On a Logical Standby Database](#).



### Note:

In general, use of the `NOLOGGING` clause is not recommended. Therefore, if you know in advance that operations using the `NOLOGGING` clause will be performed on certain tables in the primary database, then you might want to prevent the application of SQL statements associated with these tables to the logical standby database. You can do this by using the `DBMS_LOGSTDBY.SKIP` procedure.

## 15.4.2 Recovery Steps for Physical Standby Databases

When the redo is applied to the physical standby database, a portion of the data file is marked as being unrecoverable. When you either fail over to the physical standby database, or open the standby database for read-only access, and attempt to read the range of blocks that are marked as `UNRECOVERABLE`, you see error messages similar to the following:

```
ORA-01578: ORACLE data block corrupted (file # 1, block # 2521)
ORA-01110: data file 1: '/oracle/dbs/stdby/tbs_1.dbf'
ORA-26040: Data block was loaded using the NOLOGGING option
```

When you use `STANDBY NOLOGGING FOR LOAD PERFORMANCE` mode it is still possible for a query executed on a physical standby to report a corrupt block due to a nologging operation. However, when managed recovery is running on that standby as part of an Active Data Guard configuration, it automatically fetches a replacement block from the primary. (Managed recovery is started with the `ALTER DATABASE RECOVER MANAGED STANDBY DATABASE DISCONNECT` statement.) Managed recovery attempts to fetch all

such blocks shortly after they are first created and continues attempting to fix them until it succeeds. Whenever managed recovery is started, it again begins fixing any outstanding blocks from earlier recovery sessions. This automatic recovery applies only to corrupt blocks caused by redo generated with the `STANDBY NOLOGGING FOR LOAD PERFORMANCE` mode enabled. Blocks corrupted due to conventional nonlogged operations must use the following procedure. These steps describe a simple approach that recovers all nonlogged blocks. (See follow-on sections for other approaches such as determining whether a backup is required after unrecoverable operations, and recovering parts of a physical standby database.)

1. Stop recovery on the standby:

```
SQL> ALTER DATABASE RECOVER MANAGED STANDBY DATABASE CANCEL;
```

2. Recover the nonlogged blocks by connecting RMAN to the standby and issue the following command:

```
RMAN> RECOVER DATABASE NONLOGGED BLOCK;
```

If the presence of unrecoverable blocks is only found after a switchover, then you can use these same two steps, but the primary database must be just mounted ( not open) and, RMAN must be connected to the primary.

It is possible that the RMAN `RECOVER` command may not be able to recover all the nonlogged blocks. The reasons that this might happen are detailed in the alert log of the database from which the RMAN command was executed. The most common reason is that a block has been modified recently at the primary and not yet written to its corresponding data file. This may mean that the block sent to the standby is too old to replace the unrecoverable block on the standby. To resolve this, issue the `RECOVER` command again at a later time after the block has been written out to the data file.

The following is an example of an alert log entry for an execution of the `RECOVER` command which left some blocks unrecovered:

```
Started Nonlogged Block Replacement recovery on file 7 (ospid 13005
rcvid 11319003446180375696)
Finished Nonlogged Block Replacement recovery on file 7. 5 blocks remain
  Statistics for replacement block source database (service=dg3tns)
  (Use of it stopped due to error 12942 received from it)
  Blocks requested 5, blocks received 0.

Reason replacement blocks accepted or rejected          Blocks
Last block
-----
-----
Not received: Rejected by sender. Wrong state or SCN
5           21
```

In this case, the command was run on a standby and the primary did not send any blocks but instead reported the following Oracle error: .

```
ORA-12942: database incarnation at source does not match
```

An examination of the alert logs would reveal that the primary had performed `FLASHBACK DATABASE` and `OPEN RESETLOGS` commands, but the standby had not been flashed back. This means the standby would now be on an orphaned branch of redo and therefore the primary could not supply data blocks that would be known to be the correct version.

 **Note:**

When a Data Guard configuration has more than one standby, an `RMAN RECOVER` command that is run at a standby attempts to fetch blocks from the primary only. When the `RECOVER` command is run at the primary it attempts to fetch blocks from only the one standby that it determines to be most likely to yield good blocks, which typically means the standby that is closest to being in synch with the primary.

### 15.4.3 Determining If a Backup Is Required After Unrecoverable Operations

If you performed unrecoverable operations on your primary database, then you need to determine if a new backup operation is required.

To do so, take the following steps:

1. Query the `V$DATAFILE` view on the primary database to determine the **system change number (SCN)** or the time at which the Oracle database generated the most recent invalidated redo data.
2. Issue the following SQL statement on the primary database to determine if you need to perform another backup:

```
SQL> SELECT UNRECOVERABLE_CHANGE#, -  
> TO_CHAR(UNRECOVERABLE_TIME, 'mm-dd-yyyy hh:mi:ss') -  
> FROM V$DATAFILE;
```

3. If the query in the previous step reports an unrecoverable time for a data file that is more recent than the time when the data file was last backed up, then make another backup of the data file in question.

See *Oracle Database Reference* for more information about the `V$DATAFILE` view.

### 15.4.4 Recovery Steps for Part of a Physical Standby Database

The `RMAN RECOVER ... NONLOGGED BLOCK` command can be used to recover blocks that belong to a set of data files or a set of tablespaces or just a single pluggable database (PDB) as well as the multitenant container database (CDB).

This ability may be useful if it is acceptable to have nonlogged blocks remain in some data files, for example because it is explicitly known that the nonlogged blocks were created as a result of loading rows into an object that has now been dropped.

The view `V$NONLOGGED_BLOCK` usually lists the ranges of known invalid blocks for each data file and the entries are maintained as part of media recovery. However, there are times when the information is not complete. Typically this is after upgrading from a release prior to Oracle Database 12c Release 1 (12.1) or after restoring an operating system backup of a data file. The next time media recovery is run, the stale entries are

removed and any newly invalidated blocks are recorded but any prior invalid blocks do not have entries in `V$NONLOGGED_BLOCK`. The `FIRST_NONLOGGED_SCN` column in the `V$DATAFILE` view can still be used to see that there is at least one invalid block in a data file even when there are no `V$NONLOGGED_BLOCK` entries for a data file.

The RMAN command `VALIDATE ... NONLOGGED BLOCK` can be used to bring the entries in `V$NONLOGGED_BLOCK` back into synchronization with the data files. It does this by determining if the existing ranges are complete and if not, it scans the necessary data files to identify any invalid blocks and make sure they are captured by an entry in `V$NONLOGGED_BLOCK`. The `VALIDATE ... NONLOGGED BLOCK` command has the same options as the `RECOVER ... NONLOGGED BLOCK` command to validate just a set of data files or a set of tablespaces or a PDB, as well as the CDB.

 **Note:**

Entries in the `V$NONLOGGED_BLOCK` view represent a superset of the invalid blocks, and some normal blocks that are close to an invalid block may be included. For example, if there is an entry for file 7 that starts at block 100 and has 50 blocks in it, then none, some, or all of those 50 blocks are invalid. After the `VALIDATE` command is run, there are no ranges that have no invalid blocks in them and the first and last block of a range are also be invalid blocks. However, there are limits to the total number of ranges that can be held in the control file so sometimes it may be necessary to merge ranges for the same file, causing regular blocks to be included in a range.

If only offline data files are to be validated or recovered then the database to which they belong can be open at the time the RMAN command is run.

## 15.5 Creating a Standby Database That Uses OMF or Oracle ASM

When you create standby databases, there are additional steps that must be performed if the primary database uses Oracle Managed Files (OMF) or Oracle Automatic Storage Management (Oracle ASM).

The discussion in this section is presented at a level of detail that assumes you already know how to create a physical standby database and are an experienced user of the RMAN, OMF, and Oracle ASM features.

Perform the following tasks to prepare for standby database creation:

1. Enable forced logging on the primary database.
2. Enable archiving on the primary database.
3. Set all necessary initialization parameters on the primary database.
4. Create an initialization parameter file for the standby database.
5. If the primary database is configured to use OMF, then Oracle recommends that the standby database be configured to use OMF, too. To do this, set the `DB_CREATE_FILE_DEST` and `DB_CREATE_ONLINE_LOG_DEST_n` initialization parameters to appropriate values. Maintenance and future role transitions are

simplified if the same disk group names are used for both the primary and standby databases.

 **Note:**

If OMF parameters are set on the standby, then new files on that standby are always created as OMF, regardless of how they were created on the primary. Therefore, if both the `DB_FILE_NAME_CONVERT` and `DB_CREATE_FILE_DEST` parameters are set on the standby, the `DB_CREATE_FILE_DEST` parameter takes precedence.

6. Set the `STANDBY_FILE_MANAGEMENT` initialization parameter to `AUTO`.
7. Configure Oracle Net, as required, to allow connections to the standby database.
8. Configure redo transport authentication as described in [Configure Redo Transport Authentication](#).
9. Start the standby database instance without mounting the control file.

Perform the following tasks to create the standby database:

1. If the standby database is going to use Oracle ASM, create an Oracle ASM instance if one does not already exist on the standby database system.
2. Use the `RMAN BACKUP` command to create a backup set that contains a copy of the primary database's data files, archived log files, and a standby control file.
3. Use the `RMAN DUPLICATE FOR STANDBY` command to copy the data files, archived redo log files and standby control file in the backup set to the standby database's storage area.

The `DUPLICATE FOR STANDBY` command performs the actual data movement at the standby instance. If the backup set is on tape, the media manager must be configured so that the standby instance can read the backup set. If the backup set is on disk, the backup pieces must be readable by the standby instance, either by making their primary path names available through Network File Storage (NFS), or by copying them to the standby system and using `RMAN CATALOG BACKUPPIECE` command to catalog the backup pieces before restoring them.

After you successfully complete these steps, continue with the steps in [Verify the Physical Standby Database Is Performing Properly](#), to verify the configuration of the physical standby database.

To create a logical standby database, continue with the standby database creation process described in [Creating a Logical Standby Database](#), but with the following modifications:

1. For a logical standby database, setting the `DB_CREATE_FILE_DEST` parameter does not force the creation of OMF filenames. However, if this parameter was set on the primary database, it must also be set on the standby database.
2. After creating a logical standby control file on the primary system, do not use an operating system command to copy this file to the standby system. Instead, use the `RMAN RESTORE CONTROLFILE` command to restore a copy of the logical standby control file to the standby system.
3. If the primary database uses OMF files, use `RMAN` to update the standby database control file to use the new OMF files created on the standby database.

To perform this operation, connect only to the standby database, as shown in the following example:

```
> RMAN TARGET sys@lstdby

target database Password: password

RMAN> CATALOG START WITH '+stby_diskgroup';
RMAN> SWITCH DATABASE TO COPY;
```

After you successfully complete these steps, continue with the steps in [Open the Logical Standby Database](#) to start, recover, and verify the logical standby database.

### See Also:

- [Creating a Physical Standby Database](#)
- [Creating a Logical Standby Database](#)
- [Creating a Standby Database with Recovery Manager](#)
- *Oracle Database Administrator's Guide* for information about OMF
- *Oracle Automatic Storage Management Administrator's Guide* for more information about Oracle ASM
- *Oracle Database Backup and Recovery User's Guide* for information about RMAN

## 15.6 Recovering From Lost-Write Errors on a Primary Database

During media recovery in an Oracle Data Guard configuration, a physical standby database can be used to detect lost-write data corruption errors on the primary database.

This is done by comparing SCNs of blocks stored in the redo log on the primary database to SCNs of blocks on the physical standby database. If the SCN of the block on the primary database is lower than the SCN on the standby database, then there was a lost-write error on the primary database.

In such a situation, if lost write detection (set with the `DB_LOST_WRITE_PROTECT` initialization parameter) is enabled at both the primary and standby, then a recovery attempt at the standby results in an `ORA-752` error. If lost write detection is not enabled, then a recovery attempt results in an `ORA-600 [3020]` error. However, not all `ORA-600 [3020]` errors are due to lost writes at the primary. Therefore, before following the guidelines given in this section, work with your Oracle Support representative to determine whether the root cause for the `ORA-600 [3020]` error was indeed a lost write that occurred on the primary. Also see "Resolving `ORA-752` or `ORA-600 [3020]` During Standby Recovery" in the My Oracle Support Note 1265884.1 at <http://support.oracle.com>.



 **Note:**

Because lost-write errors are detected only when a block is read into the cache by a primary and the corresponding redo is later compared to the block on the standby, there may be undetected stale blocks on both the primary and the standby that have not yet been read and verified. These stale blocks do not affect operation of the current database because until those blocks are read, all blocks that have been used up to the SCN of the currently applied redo on the standby to do queries or updates were verified by the standby.

When a primary lost-write error is detected on the standby, one or more block error messages similar to the following for each stale block are printed in the alert file of the standby database:

```
Tue Dec 12 19:09:48 2006
STANDBY REDO APPLICATION HAS DETECTED THAT THE PRIMARY DATABASE
LOST A DISK WRITE OF BLOCK 26, FILE 7
NO REDO AT OR AFTER SCN 389667 CAN BE USED FOR RECOVERY.
.
.
.
```

The alert file then shows that an ORA-00752 error is raised on the standby database and the managed recovery is cancelled:

```
Slave exiting with ORA-752 exception
Errors in file /oracle/log/diag/rdbms/dgstwrite2/stwrite2/trace/
stwrite2_pr00_23532.trc:
ORA-00752: recovery detected a lost write of a data block
ORA-10567: Redo is inconsistent with data block (file# 7, block# 26)
ORA-10564: tablespace TBS_2
ORA-01110: data file 7: '/oracle/dbs/btbs_21.f'
ORA-10561: block type 'TRANSACTION MANAGED DATA BLOCK', data object# 57503
.
.
.
```

The standby database is then recovered to a consistent state, without any corruption to its data files caused by this error, at the SCN printed in the alert file:

```
Recovery interrupted!
Recovered data files to a consistent state at change 389569
```

This last message may appear significantly later in the alert file and it may have a lower SCN than the block error messages. Also, the primary database may operate without visible errors even though its data files may already be corrupted.

The recommended procedure to recover from such errors is a failover to the physical standby, as described in the following steps.

### Steps to Failover to a Physical Standby After Lost-Writes Are Detected on the Primary

1. Shut down the primary database. All data at or after the SCN printed in the block error messages is lost.

2. Issue the following SQL statement on the standby database to convert it to a primary:

```
SQL> ALTER DATABASE ACTIVATE STANDBY DATABASE;
```

```
Database altered.
```

```
Tue Dec 12 19:15:23 2006
alter database activate standby database
ALTER DATABASE ACTIVATE [PHYSICAL] STANDBY DATABASE (stwrite2)
RESETLOGS after incomplete recovery UNTIL CHANGE 389569
Resetting resetlogs activation ID 612657558 (0x24846996)
Online log /oracle/dbs/bt_log1.f: Thread 1 Group 1 was previously
cleared
Online log /oracle/dbs/bt_log2.f: Thread 1 Group 2 was previously
cleared
Standby became primary SCN: 389567
Tue Dec 12 19:15:23 2006
Setting recovery target incarnation to 3
Converting standby mount to primary mount.
ACTIVATE STANDBY: Complete - Database mounted as primary (stwrite2)
Completed: alter database activate standby database
```

3. Back up the new primary. Performing a backup immediately is a necessary safety measure, because you cannot recover changes made after the failover without a complete backup copy of the database. As a result of the failover, the original primary database can no longer participate in the Oracle Data Guard configuration, and all other standby databases now receive and apply redo data from the new primary database.
4. Open the new primary database.
5. An optional step is to recreate the failed primary as a physical standby. You can do this using the database backup taken at the new primary in step 3. (You cannot use flashback database or the Oracle Data Guard broker to reinstantiate the old primary database in this situation.) Be aware that a physical standby created using the backup taken from the new primary has the same data files as the old standby. Therefore, any undetected lost writes that the old standby had before it was activated are not detected by the new standby, since the new standby compares the same blocks. Any new lost writes that happen on either the primary or the standby are detected.

#### See Also:

*Oracle Database Backup and Recovery User's Guide* for more information about enabling lost-write detection

## 15.7 Using the DBCOMP Procedure to Detect Lost Writes and Other Inconsistencies

You can use the PL/SQL procedure, `DBMS_DBCOMP.DBCOMP`, to detect lost writes and also to detect inconsistencies between a primary database and physical standby databases.

The `DBMS_DBCOMP.DBCOMP` procedure compares the same data blocks on the primary and physical standby databases. The procedure can be executed at any time. (It does not require that the `DB_LOST_WRITE_PROTECT` initialization parameter be enabled.) You can monitor the progress of an on-going block comparison operation by querying the `V$SESSION_LONGOPS` view.



### Note:

Logical standby databases, far sync instances, and cascaded standbys cannot be the target database for the `DBMS_DBCOMP.DBCOMP` procedure.

The `DBMS_DBCOMP.DBCOMP` procedure assumes that there is one primary database and one or more physical standby databases. The databases should be at least mounted before block comparison.

In the following example situations, assume that there is a primary database with a unique name of `dgmain`, and that physical standby databases are named `dgmainb`, `dgmainc`, `dgmaind`, and so on.

### Example 15-1 Primary and All Standbys Are Mounted or Open and DBCOMP Is Executed From the Primary

In this situation, when the `DBCOMP` procedure is executed from the primary database, the specified data files are compared block by block between the primary and every physical standby database. For example, suppose that you perform the following query:

```
SQL> exec sys.dbms_dbcomp.dbcomp('1','BlockCompare',:retval);
```

The generated output files are `BlockCompare_dgmainb_1` and `BlockCompare_dgmainc_d_1`.

### Example 15-2 Primary and All Standbys Are Mounted or Open and DBCOMP Is Executed From a Standby

In this situation, when the `DBCOMP` procedure is executed from one of the standby databases (for example, `dgmainb`), the specified data files are compared only between the primary and that particular standby database. Other standby databases are not considered. For example, suppose that you perform the following query:

```
SQL> exec sys.dbms_dbcomp.dbcomp('1','BlockCompare',:retval);
```

The generated output file is `BlockCompare_dgmain_1`.

**Example 15-3 Primary Is Mounted or Open, But Not All Standbys Are, and DBCOMP is Executed From the Primary**

In this situation, when the `DBCOMP` procedure is executed on the primary, the specified data files are compared between the primary database and the mounted or open physical standby databases. For those standby databases that are neither mounted nor open, no action is taken.

**Example 15-4 Primary Is Mounted or Open, But Not All Standbys Are, and DBCOMP is Executed From a Standby**

In this situation, the specified data files are compared between the primary and the standby from which the `DBCOMP` procedure is executed.

**Example 15-5 Primary is Not Mounted, But Multiple Standbys Are Mounted or Open**

Because the primary database is neither mounted nor open, the `DBCOMP` procedure cannot find an appropriate pair of primary and physical standby databases to compare. An `ORA` error message is not returned, but a message similar to the following is printed out in the corresponding output file: `Remote database is not in the primary role.`

**Example 15-6 Primary Is Mounted or Open, But No Standbys Are Mounted or Open**

Because no appropriate pair of primary and physical standby databases are found, a message is printed out in the corresponding output file, but no `ORA` error is returned.

**Related Topics**

- [Oracle Database PL/SQL Packages and Types Reference](#)

## 15.8 Converting a Failed Primary into a Standby Database Using RMAN Backups

To convert a failed primary database, Oracle recommends that you enable the Flashback Database feature on the primary and follow one of these procedures, as appropriate.

- [Flashing Back a Failed Primary Database into a Physical Standby Database](#)
- [Flashing Back a Failed Primary Database into a Logical Standby Database](#)

The procedures in these sections describe the fastest ways to convert a failed primary into either a physical or logical standby. However, if Flashback Database was not enabled on the failed primary, you can still convert the failed primary into either a physical or logical standby using a local backup of the failed primary, as described in the following topics:

- [Converting a Failed Primary into a Physical Standby Using RMAN Backups](#)
- [Converting a Failed Primary into a Logical Standby Using RMAN Backups](#)

## 15.8.1 Converting a Failed Primary into a Physical Standby Using RMAN Backups

These steps describe how to convert a failed primary into a physical standby by using RMAN backups.

This procedure requires that the `COMPATIBLE` initialization parameter of the old primary be set to at least 11.0.0.

1. On the new primary database, issue the following query to determine the SCN at which the old standby database became the new primary database:

```
SQL> SELECT TO_CHAR(STANDBY_BECAME_PRIMARY_SCN) FROM V$DATABASE;
```

2. Restore the database with a backup taken before the old primary had reached the SCN at which the standby became the new primary (`standby_became_primary_scn`). Then, perform a point-in-time recovery to recover the old primary to that same point.

Issue the following RMAN commands:

```
RMAN> RUN
  {
    SET UNTIL SCN <standby_became_primary_scn + 1>;
    RESTORE DATABASE;
    RECOVER DATABASE;
  }
```

With user-managed recovery, you can first restore the database manually. Typically, a backup taken a couple of hours before the failover would be old enough. You can then recover the failed primary using the following command:

```
SQL> RECOVER DATABASE USING BACKUP CONTROLFILE UNTIL CHANGE -
> <standby_became_primary_scn + 1>;
```

Unlike a reinstatement that uses Flashback Database, this procedure adds one to `standby_became_primary_scn`. For data files, flashing back to an SCN is equivalent to recovering up until that SCN plus one.

3. Perform the following steps on the old primary database:
  - a. Issue the following statement on the old primary database:

```
SQL> ALTER DATABASE CONVERT TO PHYSICAL STANDBY;
```

- b. Shut down and restart the database:

```
SQL> SHUTDOWN IMMEDIATE;
SQL> STARTUP MOUNT;
```

4. Issue the following command:

```
SQL> ALTER DATABASE OPEN READ ONLY;
```

The goal of this step is to synchronize the control file with the database by using a dictionary check. After this command, check the alert log for any actions suggested by the dictionary check. Typically, no user action is needed if the old primary was not in the middle of adding or dropping data files during the failover.

5. If you have purchased a license for the Oracle Active Data Guard option and would like to operate your physical standby database in active query mode, skip this step. Otherwise, bring your standby database to the mount state.

For example:

```
SQL> SHUTDOWN IMMEDIATE;
SQL> STARTUP MOUNT;
```

6. Before the new standby database was created, the new primary database probably stopped transmitting redo to the remote destination. To restart redo transport services, perform the following steps on the new primary database:
  - a. Issue the following query to see the current state of the archive destinations:

```
SQL> SELECT DEST_ID, DEST_NAME, STATUS, PROTECTION_MODE, DESTINATION, -
> ERROR,SRL FROM V$ARCHIVE_DEST_STATUS;
```

- b. If necessary, enable the destination:

```
SQL> ALTER SYSTEM SET LOG_ARCHIVE_DEST_1=ENABLE;
```

- c. Perform a log switch to ensure the standby database begins receiving redo data from the new primary database, and verify it was sent successfully.

#### Note:

This is an important step in order for the old primary to become a new standby following the new primary. If this step is not done, the old primary may recover to an incorrect database branch. The only way to correct the problem then is to convert the old primary again.

At the SQL prompt, enter the following statements:

```
SQL> ALTER SYSTEM SWITCH LOGFILE;
SQL> SELECT DEST_ID, DEST_NAME, STATUS, PROTECTION_MODE, DESTINATION, -
> ERROR,SRL FROM V$ARCHIVE_DEST_STATUS;
```

On the new standby database, you may also need to change the `LOG_ARCHIVE_DEST_1` initialization parameters so that redo transport services do not transmit redo data to other databases. This step can be skipped if both the primary and standby database roles were set up with the `VALID_FOR` attribute in one server parameter file (SPFILE). By doing this, the Oracle Data Guard configuration operates properly after a role transition.

7. Start Redo Apply on the new physical standby database, as follows:

```
SQL> ALTER DATABASE RECOVER MANAGED STANDBY DATABASE DISCONNECT;
```

Once the failed primary database is restored and is running in the standby role, you can optionally perform a switchover to transition the databases to their original (pre-failure) roles. See ["Performing a Switchover to a Physical Standby Database"](#) for more information.

## 15.8.2 Converting a Failed Primary into a Logical Standby Using RMAN Backups

These steps describe how to convert a failed primary into a logical standby using RMAN backups.

1. On the new primary database, issue the following query to determine the SCN to which you want to recover the failed primary database:

```
SQL> SELECT APPLIED_SCN RECOVERY_SCN FROM V$LOGSTDBY_PROGRESS;
```

Also on the new primary database, determine the SCN to use in dealing with archive logs, as follows:

- a. Ensure all standby redo logs have been archived. Issue the following query, looking for a value of `NONE` to be returned. Depending on the size of the database and the number of logs needing to be archived, it could take some time before a status of `NONE` is returned.

```
SQL> SELECT PENDING_ROLE_CHANGE_TASKS FROM V$DATABASE;
```

- b. After a status of `NONE` has been returned, run the following query to retrieve the SCN for dealing with archive logs as part of this recovery:

```
SQL> SELECT VALUE ARCHIVE_SCN FROM SYSTEM.LOGSTDBY$PARAMETERS -  
> WHERE NAME='STANDBY_BECAME_PRIMARY_SCN';
```

2. Remove any archive logs created at the time of, or after the failover operation, from the failed primary database. If the failed primary database was isolated from the standby, it could have divergent archive logs that are not consistent with the current primary database. To ensure these divergent archive logs are never applied, they must be deleted from backups and the fast recovery area. You can use the following RMAN command to delete the relevant archive logs from the fast recovery area:

```
RMAN> DELETE FORCE ARCHIVELOG FROM SCN ARCHIVE_SCN;
```

Once deleted, these divergent logs and subsequent transactions can never be recovered.

3. On the new primary database, issue the following query to determine the minimum set of log files that must be copied to the failed primary database before recovering from a backup:

```
SQL> SELECT file_name FROM DBA_LOGSTDBY_LOG WHERE next_change# > ARCHIVE_SCN;
```

Retrieve the required standby logs, copy the backup set to the new standby and restore it to the new standby fast recovery area. Because these logs are coming from standby redo logs, they are not part of the standby's standard archives. The RMAN utility is able to use a partial file name to retrieve the files from the correct location.

The following is a sample use of the RMAN `BACKUP` command:

```
RMAN> BACKUP AS COPY DEVICE TYPE DISK FORMAT '/tmp/test/%U'  
> ARCHIVELOG LIKE '<partial file names from above>%';
```

The following is a sample use of the RMAN `RESTORE` command:

```

RMAN> CATALOG START WITH '/tmp/test';
RMAN> RESTORE ARCHIVELOG FROM SEQUENCE 33 UNTIL SEQUENCE 35;

```

4. Restore a backup of all the original primary's data files and recover to `RECOVERY_SCN + 1`. Oracle recommends that you leverage the current control file.
  - a. Start up the database in restricted mode to protect it from rogue transactions until the `GUARD ALL` command can be issued after the database has been opened.
  - b. Use the backup to restore the data files of the failed primary database.
  - c. Turn off flashback database, if it is enabled (necessary for the `USING BACKUP CONTROLFILE` clause).
  - d. Perform point-in-time recovery to `RECOVERY_SCN + 1` in SQL\*Plus.

Whether you are using a current control file or a backup control file, you must specify the `USING BACKUP CONTROLFILE` clause to allow you to point to the archive logs being restored. Otherwise, the recovery process could attempt to access online redo logs instead of the logs retrieved in Step 3. When prompted for the sequences retrieved in Step 3, ensure you specify the file names of the restored archive log copies, as follows:

```
SQL> RECOVER DATABASE UNTIL CHANGE RECOVERY_SCN + 1 USING BACKUP CONTROLFILE;
```

5. Open the database with the `RESETLOGS` option:

```
SQL> ALTER DATABASE OPEN RESETLOGS;
```

6. Enable Database Guard

```
SQL> ALTER DATABASE GUARD ALL;
```

7. Create a database link to the new primary database and start SQL Apply:

```

SQL> CREATE PUBLIC DATABASE LINK myLink -
> CONNECT TO SYSTEM IDENTIFIED BY password -
> USING 'service name of new primary database';

```

```
SQL> ALTER DATABASE START LOGICAL STANDBY APPLY NEW PRIMARY myLink;
```

At this point, you can disable restricted session (`ALTER SYSTEM DISABLE RESTRICTED SESSION`) or, if you need to restart the database to re-enable Flashback from Step 4c, let this restart turn off `RESTRICTED SESSION`.

## 15.9 Changing the Character Set of a Primary Without Re-Creating Physical Standbys

Oracle Data Guard allows you to change both the database character set and the national character set of a primary database without requiring you to recreate any physical standby databases in the configuration.

You can continue to use your physical standby database with minimal disruption while performing character set conversion of a primary database.

The character set migration process consists of preparatory steps such as scanning for possible issues and identifying methods to solve them. During the execution of these preparatory steps the Oracle Data Guard configuration can operate unchanged and no extra steps are required to maintain the physical standby. After the preparatory steps are completed, the actual conversion is performed which may involve changes



to both system data (metadata) and user data. Several procedures specific to Oracle Data Guard must be run as part of the conversion. The steps to run these procedures are interspersed with the steps performed by the Database Migration Assistant for Unicode (DMU) or other appropriate character set migration tool.

For a detailed description of the steps involved in this process, see My Oracle Support note 1124165.1 at <http://support.oracle.com>.

## 15.10 Actions Needed On a Standby After a PDB PITR or PDB Flashback On a Primary

After you perform a PDB PITR or PDB Flashback on a primary, you can either restore the PDB or flashback the PDB on the standby to let the standby follow the primary.

With Oracle Database Release 19c, if the standby is in mount mode and flashback database is enabled, you may not need to do anything. In the common case, if there is sufficient flashback data, the standby is automatically flashed back so that the standby continues to follow the primary.

In all other cases, when a PDB PITR or PDB flashback is performed on the primary, and redo for the start of the operation is encountered for the first time, the MRP at the standby terminates with error `ORA-39874`, followed by the supplemental error `ORA-39873`. The following is an example of the messages that may appear in the alert log:

```
Recovery of pluggable database PDB1 aborted due to pluggable database open
resetlog marker.
To continue recovery, restore all data files for this PDB to
checkpoint SCN lower than 1437261, or timestamp before 11/15/2012 16:38:49,
and restart recovery
MRP0: Background Media Recovery terminated with error 39874
```

```
ORA-39874: Pluggable Database PDB1 recovery halted
ORA-39873: Restore all data files to a checkpoint SCN lower than 1437261.
```

With Oracle Database Release 19c, if the standby is open and flashback database is enabled, you can place the standby in mount mode and start standby recovery. The MRP, in an attempt to allow the standby to follow the primary, triggers an automatic flashback of the standby. If this succeeds, as reported in the alert log, you need to just follow up with opening the Active Data Guard instance. If automatic flashback is not triggered, or automatic flashback did not result in the standby following the primary, then you can perform the manual steps described in this section.

Before media recovery on the standby can continue any further, you must restore all data files for that PDB. You can do this in two ways:

- If flashback is enabled on the standby, then you can use PDB flashback on the standby and then restart standby managed recover. See “Performing Recovery When Flashback is Enabled” below.
- If flashback is not enabled on the standby, then recovery can be done from a backup taken at a time prior to the point-in-time the PDB was recovered on the primary. See “Performing Recovery When Flashback is Not Enabled” below.

With either method, a PDB that has undergone PDB PITR or flashback on the primary cannot be opened on a standby until it has caught up with the rest of the standby.

## Performing Recovery When Flashback Is Enabled

If flashback is enabled on the standby, you can flashback the PDB on the standby and then restart standby managed recovery.

1. Determine the affected PDB and PITR SCN.

The name of the PDB for which recovery was halted is shown in the ORA-39874 message and the PITR SCN is shown in the ORA-39873 message.

2. Close the standby database, if it is still open:

```
SQL> ALTER DATABASE CLOSE;
```

3. Flashback the pluggable database on the standby:

```
SQL> FLASHBACK PLUGGABLE DATABASE pdb1 TO SCN 1437260;
```

The SCN for the `FLASHBACK PLUGGABLE DATABASE` command is 1437260, not 1437261 as in the following example, because `TO SCN` and `UNTIL SCN` have different semantics.

4. Restart media recovery on the standby:

```
SQL> RECOVER MANAGED STANDBY DATABASE DISCONNECT;
```

## Performing Recovery When Flashback Is Not Enabled

1. Determine the affected PDB and PITR SCN.

The name of the PDB for which recovery was halted is shown in the ORA-39874 message and the PITR SCN is shown in the ORA-39873 message.

2. Close the standby database, if it is still open:

```
SQL> ALTER DATABASE CLOSE;
```

3. Restore the PDB data files:

```
RMAN> RESTORE PLUGGABLE DATABASE pdb1 UNTIL SCN 1437261;
```

The `UNTIL SCN` syntax allows RMAN to automatically choose a suitable backup to restore from. After the data files have been restored at the standby, restart MRP to continue applying the redo logs.

4. Restart media recovery on the standby:

```
SQL> RECOVER MANAGED STANDBY DATABASE DISCONNECT;
```

### See Also:

- *Oracle Database Backup and Recovery User's Guide* for more information about performing point-in-time recovery of PDBs

# Part II

## Reference

The following topics provide reference material to be used in conjunction with the Oracle Data Guard standby database features. For more detailed reference material, refer to the Oracle Database documentation set.

- [Initialization Parameters](#)
- [LOG\\_ARCHIVE\\_DEST\\_n Parameter Attributes](#)
- [SQL Statements Relevant to Oracle Data Guard](#)
- [Views Relevant to Oracle Data Guard](#)

# 16

## Initialization Parameters

This is an alphabetical listing of the initialization parameters you set for a Data Guard environment. It indicates if the parameter is set for the primary role or the standby role, and also provides tips for setting each parameter.

*Oracle Database Reference* provides complete initialization parameter information, including how to update initialization parameters by issuing the ALTER SYSTEM SET statement (for example, ALTER SYSTEM SET LOG\_ARCHIVE\_TRACE) or by editing the initialization parameter files. See the Oracle operating system-specific documentation for more information about setting initialization parameters.

**Table 16-1 Initialization Parameters for Instances in an Oracle Data Guard Configuration**

| Parameter                                                                                                                    | Applicable To                                                      | Notes and Recommendations                                                                                                                                                                                                                                                                                                                                                                                                                                                                                                                                                                                                                                     |
|------------------------------------------------------------------------------------------------------------------------------|--------------------------------------------------------------------|---------------------------------------------------------------------------------------------------------------------------------------------------------------------------------------------------------------------------------------------------------------------------------------------------------------------------------------------------------------------------------------------------------------------------------------------------------------------------------------------------------------------------------------------------------------------------------------------------------------------------------------------------------------|
| COMPATIBLE = <i>release_number</i>                                                                                           | Primary<br>Logical Standby<br>Physical Standby<br>Snapshot Standby | Specify the same value on the primary and standby databases if you expect to do a switchover. If the values differ, redo transport services may be unable to transmit redo data from the primary database to the standby databases. See <a href="#">Create a Parameter File for the Standby Database</a> for an example.<br><br>A logical standby database can have a higher COMPATIBLE setting than the primary database if a switchover is not expected.<br><br>For rolling upgrades using SQL Apply, set this parameter according to the guidelines described in <a href="#">Performing a Rolling Upgrade By Creating a New Logical Standby Database</a> . |
| CONTROL_FILE_RECORD_KEEP_TIME = <i>number_of_days</i>                                                                        | Primary<br>Logical Standby<br>Physical Standby<br>Snapshot Standby | Optional. Use this parameter to avoid overwriting a reusable record in the control file (that contains needed information such as an archived redo log file) for the specified number of days (from 0 to 365).                                                                                                                                                                                                                                                                                                                                                                                                                                                |
| CONTROL_FILES =<br>' <i>control_file_name</i> ',<br>' <i>control_file_name</i> ', '...'                                      | Primary<br>Logical Standby<br>Physical Standby<br>Snapshot Standby | Required. Specify the path name and filename for one or more control files. The control files must already exist on the database. Oracle recommends using 2 control files. If another copy of the current control file is available, then an instance can be easily restarted after copying the good control file to the location of the bad control file. See <a href="#">Create a Parameter File for the Standby Database</a> for an example.                                                                                                                                                                                                               |
| DB_FILE_NAME_CONVERT =<br>' <i>location_of_primary_database_datafile</i> ', ' <i>location_of_standby_database_datafile</i> ' | Physical Standby<br>Snapshot Standby                               | This parameter must specify paired strings. The first string is a sequence of characters to be looked for in a primary database filename. If that sequence of characters is matched, it is replaced by the second string to construct the standby database filename. You can specify multiple pairs of filenames.                                                                                                                                                                                                                                                                                                                                             |

**Table 16-1 (Cont.) Initialization Parameters for Instances in an Oracle Data Guard Configuration**

| Parameter                                                                                                | Applicable To                                                      | Notes and Recommendations                                                                                                                                                                                                                                                                                                                                                                   |
|----------------------------------------------------------------------------------------------------------|--------------------------------------------------------------------|---------------------------------------------------------------------------------------------------------------------------------------------------------------------------------------------------------------------------------------------------------------------------------------------------------------------------------------------------------------------------------------------|
| <code>DB_UNIQUE_NAME = Unique name for the database</code>                                               | Primary<br>Logical Standby<br>Physical Standby<br>Snapshot Standby | Recommended, but required if you specify the <code>LOG_ARCHIVE_CONFIG</code> parameter. Specifies a unique name for this database. This name does not change even if the primary and standby databases reverse roles. The <code>DB_UNIQUE_NAME</code> parameter defaults to the value of the <code>DB_NAME</code> parameter.                                                                |
| <code>FAL_CLIENT = Oracle_Net_service_name</code>                                                        | Physical Standby<br>Snapshot Standby                               | This parameter is no longer required. If it is not set, the fetch archive log (FAL) server obtains the client's network address from the <code>LOG_ARCHIVE_DEST_n</code> parameter that corresponds to the client's <code>DB_UNIQUE_NAME</code> .                                                                                                                                           |
| <code>FAL_SERVER = Oracle_Net_service_name</code>                                                        | Physical Standby<br>Snapshot Standby                               | Specifies one or more Oracle Net service names for the databases from which this standby database can fetch (request) missing archived redo log files.                                                                                                                                                                                                                                      |
| <code>INSTANCE_NAME</code>                                                                               | Primary<br>Logical Standby<br>Physical Standby<br>Snapshot Standby | Optional. If this parameter is defined and the primary and standby databases reside on the same host, specify a different name for the standby database than you specify for the primary database. See <a href="#">Create a Parameter File for the Standby Database</a> for an example.                                                                                                     |
| <code>LOG_ARCHIVE_CONFIG = 'DG_CONFIG=( db_unique_name, db_unique_name, ... )'</code>                    | Primary<br>Logical Standby<br>Physical Standby<br>Snapshot Standby | Highly recommended. The <code>DG_CONFIG</code> attribute of this parameter must be explicitly set on each database in an Oracle Data Guard configuration to enable full Oracle Data Guard functionality. Set <code>DG_CONFIG</code> to a text string that contains the <code>DB_UNIQUE_NAME</code> of each database in the configuration, with each name in this list separated by a comma. |
| <code>LOG_ARCHIVE_DEST_n = {LOCATION=path_name   SERVICE=service_name, attribute, attribute, ...}</code> | Primary<br>Logical Standby<br>Physical Standby<br>Snapshot Standby | Required. Define up to thirty (where $n = 1, 2, 3, \dots, 31$ ) destinations, each of which must specify either the <code>LOCATION</code> or <code>SERVICE</code> attribute. Specify a corresponding <code>LOG_ARCHIVE_DEST_STATE_n</code> parameter for every <code>LOG_ARCHIVE_DEST_n</code> parameter.                                                                                   |
| <code>LOG_ARCHIVE_DEST_STATE_n = {ENABLE DEFER ALTERNATE}</code>                                         | Primary<br>Logical Standby<br>Physical Standby<br>Snapshot Standby | Required. Specify a <code>LOG_ARCHIVE_DEST_STATE_n</code> parameter to enable or disable redo transport services to transmit redo data to the specified (or to an alternate) destination. Define a <code>LOG_ARCHIVE_DEST_STATE_n</code> parameter for every <code>LOG_ARCHIVE_DEST_n</code> parameter. See also <a href="#">LOG_ARCHIVE_DEST_n Parameter Attributes</a> .                  |
| <code>LOG_ARCHIVE_FORMAT=log%d_%.t_%.s_%.r.arc</code>                                                    | Primary<br>Logical Standby<br>Physical Standby<br>Snapshot Standby | The <code>LOG_ARCHIVE_FORMAT</code> and <code>LOG_ARCHIVE_DEST_n</code> parameters are concatenated together to generate fully qualified archived redo log filenames on a database.                                                                                                                                                                                                         |
| <code>LOG_ARCHIVE_MAX_PROCESSES =integer</code>                                                          | Primary<br>Logical Standby<br>Physical Standby<br>Snapshot Standby | Optional. Specify the number (from 1 to 30) of archiver ( <code>ARCn</code> ) processes you want Oracle software to invoke initially. The default value is 4.                                                                                                                                                                                                                               |

**Table 16-1 (Cont.) Initialization Parameters for Instances in an Oracle Data Guard Configuration**

| Parameter                                                                                                                       | Applicable To                                                      | Notes and Recommendations                                                                                                                                                                                                                                                                                                                                                                                                                                                                                |
|---------------------------------------------------------------------------------------------------------------------------------|--------------------------------------------------------------------|----------------------------------------------------------------------------------------------------------------------------------------------------------------------------------------------------------------------------------------------------------------------------------------------------------------------------------------------------------------------------------------------------------------------------------------------------------------------------------------------------------|
| LOG_ARCHIVE_MIN_SUCCEED_DEST                                                                                                    | Primary<br>Logical Standby<br>Physical Standby<br>Snapshot Standby | Optional. This parameter specifies the number of local or remote MANDATORY destinations, or local OPTIONAL destinations, that a logfile group must be archived to before it can be re-used.                                                                                                                                                                                                                                                                                                              |
| LOG_ARCHIVE_TRACE= <i>integer</i>                                                                                               | Primary<br>Logical Standby<br>Physical Standby<br>Snapshot Standby | Optional. Set this parameter to trace the transmission of redo data to the standby site. The valid integer values are described in <a href="#">Setting Archive Tracing</a> .                                                                                                                                                                                                                                                                                                                             |
| LOG_FILE_NAME_CONVERT =<br>' <i>location_of_primary_database_redo_logs</i> ', ' <i>location_of_standby_database_redo_logs</i> ' | Logical Standby<br>Physical Standby<br>Snapshot Standby            | This parameter converts the path names of the primary database online redo log file to path names on the standby database. See <a href="#">Create a Parameter File for the Standby Database</a> for an example.                                                                                                                                                                                                                                                                                          |
| REMOTE_LOGIN_PASSWORDFILE =<br>{EXCLUSIVE SHARED}                                                                               | Primary<br>Logical Standby<br>Physical Standby<br>Snapshot Standby | Optional if operating system authentication is used for administrative users and SSL is used for redo transport authentication. Otherwise, this parameter must be set to EXCLUSIVE or SHARED on every database in an Oracle Data Guard configuration.                                                                                                                                                                                                                                                    |
| SHARED_POOL_SIZE = bytes                                                                                                        | Primary<br>Logical Standby<br>Physical Standby<br>Snapshot Standby | Optional. Use to specify the system global area (SGA) to stage the information read from the online redo log files. The more SGA that is available, the more information that can be staged.                                                                                                                                                                                                                                                                                                             |
| STANDBY_FILE_MANAGEMENT =<br>{AUTO   MANUAL}                                                                                    | Primary<br>Physical Standby<br>Snapshot Standby                    | Set the STANDBY_FILE_MANAGEMENT parameter to AUTO so that when data files are added to or dropped from the primary database, corresponding changes are made in the standby database without manual intervention. If the directory structures on the primary and standby databases are different, you must also set the DB_FILE_NAME_CONVERT initialization parameter to convert the filenames of one or more sets of data files on the primary database to filenames on the (physical) standby database. |

# 17

## LOG\_ARCHIVE\_DEST\_n Parameter Attributes

This is a list of the attributes for the `LOG_ARCHIVE_DEST_n` initialization parameter, (where *n* is an integer between 1 and 31).

- `AFFIRM` and `NOAFFIRM`
- `ALTERNATE`
- `COMPRESSION`
- `DB_UNIQUE_NAME`
- `DELAY`
- `ENCRYPTION`
- `GROUP`
- `LOCATION` and `SERVICE` (`LOCATION` is not supported for `LOG_ARCHIVE_DEST_11` through `LOG_ARCHIVE_DEST_31`)
- `MANDATORY` (not supported for `LOG_ARCHIVE_DEST_11` through `LOG_ARCHIVE_DEST_31`)
- `MAX_FAILURE`
- `NET_TIMEOUT`
- `NOREGISTER`
- `PRIORITY`
- `REOPEN`
- `SYNC` and `ASYN` (`SYNC` is not supported for `LOG_ARCHIVE_DEST_11` through `LOG_ARCHIVE_DEST_31`)
- `TEMPLATE`
- `VALID_FOR`

### Usage Notes

- Each database in an Oracle Data Guard configuration typically has one destination with the `LOCATION` attribute for the archival of the online and standby redo logs and one destination with the `REMOTE` attribute for every other database in the configuration.
- If configured, each `LOG_ARCHIVE_DEST_1` through `LOG_ARCHIVE_DEST_10` destination must contain either a `LOCATION` or `SERVICE` attribute to specify a local disk directory or a remotely accessed database, respectively. Each `LOG_ARCHIVE_DEST_11` through `LOG_ARCHIVE_DEST_31` destination must contain a `SERVICE` attribute.

All other attributes are optional.

- LOG\_ARCHIVE\_DEST\_11 through LOG\_ARCHIVE\_DEST\_31 can only be used when the COMPATIBLE initialization parameter is set to 11.2.0.0 or later.

 **Note:**

Several attributes of the LOG\_ARCHIVE\_DEST\_*n* initialization parameter have been deprecated. These attributes are supported for backward compatibility only and are documented in the *Oracle Database Reference*.

 **See Also:**

[Redo Transport Services](#) for more information about defining LOG\_ARCHIVE\_DEST\_*n* destinations and setting up redo transport services

## 17.1 AFFIRM and NOAFFIRM

The AFFIRM and NOAFFIRM attributes control whether a redo transport destination acknowledges received redo data before or after writing it to the standby redo log.

Definitions of each option are as follows:

- AFFIRM—specifies that a redo transport destination acknowledges received redo data *after* writing it to the standby redo log.
- NOAFFIRM—specifies that a redo transport destination acknowledges received redo data *before* writing it to the standby redo log.

| Category                  | AFFIRM                                    | NOAFFIRM                                  |
|---------------------------|-------------------------------------------|-------------------------------------------|
| Data type                 | Keyword                                   | Keyword                                   |
| Valid values              | Not applicable                            | Not applicable                            |
| Default Value             | Not applicable                            | Not applicable                            |
| Requires attributes       | SERVICE                                   | SERVICE                                   |
| Conflicts with attributes | NOAFFIRM                                  | AFFIRM                                    |
| Corresponds to            | AFFIRM column of the V\$ARCHIVE_DEST view | AFFIRM column of the V\$ARCHIVE_DEST view |

### Usage Notes

- If neither the AFFIRM nor the NOAFFIRM attribute is specified, then the default is AFFIRM when the SYNC attribute is specified and NOAFFIRM when the ASYNC attribute is specified.
- Specification of the AFFIRM attribute without the SYNC attribute is deprecated and will not be supported in future releases.



**See also:**[SYNC and ASYNC attributes](#)**Example**

The following example shows the `AFFIRM` attribute for a remote destination.

```
LOG_ARCHIVE_DEST_3='SERVICE=stby1 SYNC AFFIRM'  
LOG_ARCHIVE_DEST_STATE_3=ENABLE
```

## 17.2 ALTERNATE

The `ALTERNATE` attribute specifies an alternate archiving destination to be used when the original destination fails.

**Note:**

As of Oracle Database 12c Release 2 (12.2.0.1), you can expand the number of alternate archive destinations and functionality by using the `GROUP` and `PRIORITY` attributes in place of the `ALTERNATE` attribute for remote log archive destinations. This new method cannot be used in conjunction with the `ALTERNATE` attribute method. For more information, see [Alternate Destinations](#).

The `ALTERNATE` attribute is reserved for configuring alternate local archiving destinations. For backwards compatibility, examples of using `ALTERNATE` for remote log archiving destination are provided in [Using the ALTERNATE Attribute to Configure Remote Alternate Destinations](#).

| Category                  | ALTERNATE=LOG_ARCHIVE_DEST_n                                                                                                         |
|---------------------------|--------------------------------------------------------------------------------------------------------------------------------------|
| Data Type                 | String                                                                                                                               |
| Valid Value               | A <code>LOG_ARCHIVE_DEST_n</code> destination, where <i>n</i> is a value from 1 through 10.                                          |
| Default Value             | None. If an alternate destination is not specified, then redo transport services do not automatically change to another destination. |
| Requires attributes       | None <sup>1</sup>                                                                                                                    |
| Conflicts with attributes | <code>GROUP</code> and <code>PRIORITY</code> <sup>2</sup>                                                                            |
| Corresponds to            | <code>ALTERNATE</code> and <code>STATUS</code> columns of the <code>V\$ARCHIVE_DEST</code> view                                      |

<sup>1</sup> Although it is not mandatory that `MAX_FAILURE` be used with `ALTERNATE`, a nonzero `MAX_FAILURE` value is required for an alternate to become active. Using `ALTERNATE` with the default value of `MAX_FAILURE` (zero), does not result in any change in behavior.

<sup>2</sup> If the `REOPEN` attribute is specified with a nonzero value, then an alternate is not activated until the number of failures is greater than or equal to the value of `MAX_FAILURE`, with a minimum time period between attempts equal to the value of `REOPEN` (in seconds).

## Usage Notes

- The `ALTERNATE` attribute is optional. If an alternate destination is not specified, then archiving services do not automatically change to another destination if the original destination fails.
- You can specify only one alternate destination for each local `LOG_ARCHIVE_DEST_n` parameter (`LOCATION=...`).
- An alternate destination should specify a different disk location on the same local primary or standby database system, as shown in the examples below.
- To configure an alternate destination, set its `LOG_ARCHIVE_DEST_STATE_n` parameter to `ALTERNATE`.
- To manually enable an alternate destination, set its `LOG_ARCHIVE_DEST_STATE_n` parameter to `ENABLE`.
- If no enabled destinations reference an alternate destination, then the alternate destination is assumed to be deferred, because there is no automatic method of enabling the alternate destination. However, you can enable (or defer) alternate destinations at runtime using the `ALTER SYSTEM` statement.
- Any destination can be designated as an alternate destination, given the following restrictions:
  - At least one local destination is enabled.
  - The number of enabled destinations must meet the defined `LOG_ARCHIVE_MIN_SUCCEED_DEST` parameter value.
  - A destination cannot be its own alternate.
- When a destination fails, its alternate destination is enabled on the next archival operation. There is no support for enabling the alternate destination in the middle of the archival operation because that would require rereading already processed blocks.
- If an alternate destination is not specified, or if `MAX_FAILURE` is set to zero (the default), then archiving services do not automatically change to another destination if the original destination fails.

## Examples

These examples are included to illustrate basic concepts and are not meant to be used exactly as shown. They will be different in your configuration depending on your local archiving setup.

The following example shows a sample initialization parameter file in which a local archiving destination `LOG_ARCHIVE_DEST_1` automatically fails over to the alternate destination `LOG_ARCHIVE_DEST_2` on the next archival operation if an error occurs, such as a write failure or an allocation failure if the device were to become full.

### Example 17-1 Automatically Failing Over to an Alternate Local Destination

```
LOG_ARCHIVE_DEST_1='LOCATION=/disk1 MANDATORY MAX_FAILURE=1  
ALTERNATE=LOG_ARCHIVE_DEST_2'
```

```
LOG_ARCHIVE_DEST_STATE_1=ENABLE
```

```
LOG_ARCHIVE_DEST_STATE_2=ALTERNATE
```

```
LOG_ARCHIVE_DEST_2='LOCATION=/disk2 MANDATORY'
```

To resume archiving to the original destination, LOG\_ARCHIVE\_DEST\_1, you must re-enable it manually. Then you must reset LOG\_ARCHIVE\_DEST\_2 to its former alternate state to avoid having two active local archiving destinations. To do this, set the LOG\_ARCHIVE\_DEST\_STATE\_1 parameters back to their original values, as follows:

```
ALTER SYSTEM SET LOG_ARCHIVE_DEST_STATE_1=ENABLE
```

```
ALTER SYSTEM SET LOG_ARCHIVE_DEST_STATE_2=ALTERNATE
```

You can automate this fallback mechanism. Pair the original destination and the alternate destination by specifying an ALTERNATE attribute that points back to the preferred destination, as shown in the sample initialization parameter file in [Example 17-2](#).

### Example 17-2 Automatic Local Alternate Fallback

```
LOG_ARCHIVE_DEST_1='LOCATION=/disk1 MANDATORY MAX_FAILURE=1
ALTERNATE=LOG_ARCHIVE_DEST_2'
```

```
LOG_ARCHIVE_DEST_STATE_1=ENABLE
```

```
LOG_ARCHIVE_DEST_STATE_2=ALTERNATE
```

```
LOG_ARCHIVE_DEST_2='LOCATION=/disk2 MANDATORY
ALTERNATE=LOG_ARCHIVE_DEST_1'
```

If LOG\_ARCHIVE\_DEST\_1 becomes available again, then Oracle Data Guard automatically sets it to become the active local archiving destination and resets LOG\_ARCHIVE\_DEST\_2 as its alternate.

## 17.3 COMPRESSION

The COMPRESSION attribute is used to specify whether redo data is compressed before transmission to a redo transport destination.

### Note:

Redo transport compression is a feature of the Oracle Advanced Compression option. You must purchase a license for this option before using the redo transport compression feature.

| Category     | COMPRESSION=[ENABLE   DISABLE   ZLIB   LZO] |
|--------------|---------------------------------------------|
| Data Type    | Boolean                                     |
| Valid values | ENABLE, DISABLE, ZLIB, or LZO               |

| Category                  | COMPRESSION=[ENABLE   DISABLE   ZLIB   LZO]    |
|---------------------------|------------------------------------------------|
| Default value             | DISABLE                                        |
| Requires attributes       | None                                           |
| Conflicts with attributes | None                                           |
| Corresponds to            | COMPRESSION column of the V\$ARCHIVE_DEST view |

### Usage Notes

- The `ENABLE` option enables compression and uses the ZLIB compression algorithm by default.
- The `COMPRESSION` attribute is optional. If it is not specified, the default compression behavior is `DISABLE`.
- For Oracle Data Guard `SYNC` connection strings that also use the Oracle Data Guard `COMPRESSION` attribute, be sure the `SQLNET.COMPRESSION` configuration parameter is set to disabled (set to off) in the `sqlnet.ora` file. See *Oracle Database Net Services Reference* for more information about the `SQLNET.COMPRESSION` parameter.

### Example

The following example shows the `COMPRESSION` attribute with the `LOG_ARCHIVE_DEST_n` parameter. Since the `ENABLE` option is specified, the ZLIB compression algorithm is used.

```
LOG_ARCHIVE_DEST_3='SERVICE=denver SYNC COMPRESSION=ENABLE'
LOG_ARCHIVE_DEST_STATE_3=ENABLE
```

## 17.4 DB\_UNIQUE\_NAME

The `DB_UNIQUE_NAME` attribute specifies a unique name for the database at this destination.

| Category                  | DB_UNIQUE_NAME= <i>name</i>                                                                                      |
|---------------------------|------------------------------------------------------------------------------------------------------------------|
| Data Type                 | String                                                                                                           |
| Valid values              | The name must match the value that was defined for this database with the <code>DB_UNIQUE_NAME</code> parameter. |
| Default value             | None                                                                                                             |
| Requires attributes       | None                                                                                                             |
| Conflicts with attributes | None                                                                                                             |
| Corresponds to            | <code>DB_UNIQUE_NAME</code> column of the V\$ARCHIVE_DEST view                                                   |

### Usage Notes

- This attribute *is optional* if:
  - The `LOG_ARCHIVE_CONFIG=DG_CONFIG` initialization parameter is not specified.
  - This is a local destination (specified with the `LOCATION` attribute).

- This attribute *is required* if the LOG\_ARCHIVE\_CONFIG=DG\_CONFIG initialization parameter is specified and if this is a remote destination (specified with the SERVICE attribute).
- Use the DB\_UNIQUE\_NAME attribute to clearly identify the relationship between a primary and standby databases. This attribute is particularly helpful if there are multiple standby databases in the Oracle Data Guard configuration.
- The name specified by the DB\_UNIQUE\_NAME must match one of the DB\_UNIQUE\_NAME values in the DG\_CONFIG list. Redo transport services validate that the DB\_UNIQUE\_NAME attribute of the database at the specified destination matches the DB\_UNIQUE\_NAME attribute or the connection to that destination is refused.
- The name specified by the DB\_UNIQUE\_NAME attribute must match the name specified by the DB\_UNIQUE\_NAME initialization parameter of the database identified by the destination.

### Example

In the following example, the DB\_UNIQUE\_NAME parameter specifies `boston` (DB\_UNIQUE\_NAME=boston), which is also specified with the DB\_UNIQUE\_NAME attribute on the LOG\_ARCHIVE\_DEST\_1 parameter. The DB\_UNIQUE\_NAME attribute on the LOG\_ARCHIVE\_DEST\_2 parameter specifies the `chicago` destination. Both `boston` and `chicago` are listed in the LOG\_ARCHIVE\_CONFIG=DG\_CONFIG parameter.

```
DB_UNIQUE_NAME=boston
LOG_ARCHIVE_CONFIG='DG_CONFIG=(chicago,boston,denver) '
LOG_ARCHIVE_DEST_1='LOCATION=/arch1/
VALID_FOR=(ALL_LOGFILES,ALL_ROLES)
DB_UNIQUE_NAME=boston'
LOG_ARCHIVE_DEST_2='SERVICE=Sales_DR
VALID_FOR=(ONLINE_LOGFILES,PRIMARY_ROLE)
DB_UNIQUE_NAME=chicago'
```

## 17.5 DELAY

The DELAY attribute specifies a minimum time lag between when redo data from the primary site is archived on a standby site and when the archived redo log file is applied to the standby database or any standbys cascaded from it.

| Category                  | DELAY[= <i>minutes</i> ]                                       |
|---------------------------|----------------------------------------------------------------|
| Data Type                 | Numeric                                                        |
| Valid values              | >=0 minutes                                                    |
| Default Value             | 30 minutes                                                     |
| Requires attributes       | SERVICE                                                        |
| Conflicts with attributes | LOCATION, VALID_FOR=(*,STANDBY_ROLE)                           |
| Corresponds to            | DELAY_MINS and DESTINATION columns of the V\$ARCHIVE_DEST view |

### Usage Notes

- The DELAY attribute is optional. By default there is no delay.
- The DELAY attribute indicates the archived redo log files at the standby destination are not available for recovery until the specified time interval has expired. The time

interval is expressed in minutes, and it starts when the redo data is successfully transmitted to, and archived at, the standby site.

- The `DELAY` attribute may be used to protect a standby database from corrupted or erroneous primary data. However, there is a tradeoff because during failover it takes more time to apply all of the redo up to the point of corruption.
- The `DELAY` attribute does not affect the transmittal of redo data to a standby destination.
- If you have real-time apply enabled, then any delay that you set is ignored.
- Changes to the `DELAY` attribute take effect the next time redo data is archived (after a log switch). In-progress archiving is not affected.
- You can override the specified delay interval at the standby site, as follows:
  - For a physical standby database:
 

```
SQL> ALTER DATABASE RECOVER MANAGED STANDBY DATABASE NODELAY;
```
  - For a logical standby database:
 

```
SQL> ALTER DATABASE START LOGICAL STANDBY APPLY NODELAY;
```
- The `DELAY` value that a cascaded standby uses is the value that was set for the `LOG_ARCHIVE_DEST_n` parameter on the primary that shipped the redo to the cascading standby.

#### See Also:

*Oracle Database SQL Language Reference* for more information about these `ALTER DATABASE` statements

### Example

You can use the `DELAY` attribute to set up a configuration where multiple standby databases are maintained in varying degrees of synchronization with the primary database. However, this protection incurs some overhead during failover, because it takes Redo Apply more time to apply all the redo up to the corruption point.

For example, assume primary database A has standby databases B and C. Standby database B is set up as the disaster recovery database and therefore has no time lag. Standby database C is set up with a 2-hour delay, which is enough time to allow user errors to be discovered before they are propagated to the standby database.

The following example shows how to specify the `DELAY` attribute for this configuration:

```
LOG_ARCHIVE_DEST_1='LOCATION=/arch/dest MANDATORY'
LOG_ARCHIVE_DEST_STATE_1=ENABLE
LOG_ARCHIVE_DEST_2='SERVICE=stbyB SYNC AFFIRM'
LOG_ARCHIVE_DEST_STATE_2=ENABLE
LOG_ARCHIVE_DEST_3='SERVICE=stbyC DELAY=120'
LOG_ARCHIVE_DEST_STATE_3=ENABLE
```

 **Note:**

Alternatively, you can use Flashback Database to revert the database to a point-in-time or SCN in a different database incarnation as long as there is sufficient flashback log data. Using Flashback Database is described in *Oracle Database Backup and Recovery User's Guide*.

## 17.6 ENCRYPTION

The `ENCRYPTION` attribute is used to specify whether redo data is encrypted before transmission to a Zero Data Loss Recovery Appliance (Recovery Appliance).

 **Note:**

Redo transport encryption is allowed only for connections to a Recovery Appliance. Attempting to configure encryption on a log archive destination other than a Recovery Appliance results in an error.

| Category                  | ENCRYPTION=ENABLE or DISABLE                               |
|---------------------------|------------------------------------------------------------|
| Data type                 | Boolean                                                    |
| Valid values              | ENABLE or DISABLE                                          |
| Default value             | DISABLE                                                    |
| Requires attributes       | SERVICE                                                    |
| Conflicts with attributes | COMPRESSION, SYNC, and LOCATION                            |
| Corresponds to            | ENCRYPTION column of the <code>V\$ARCHIVE_DEST</code> view |

### Usage Notes

- The `ENCRYPTION` attribute is optional. If it is not specified, then the default encryption behavior is `DISABLE`.
- To use the `ENCRYPTION` attribute, you must set the `COMPATIBLE` initialization parameter to 11.2.0.4 or higher on the protected database.

### Example

The following example shows the `ENCRYPTION` attribute specified on the `LOG_ARCHIVE_DEST_n` parameter.

```
LOG_ARCHIVE_DEST_3='SERVICE=denver ENCRYPTION=ENABLE'
LOG_ARCHIVE_DEST_STATE_3=ENABLE
```

 **See Also:**

- *Zero Data Loss Recovery Appliance Administrator's Guide* for more information about redo encryption using the `LOG_ARCHIVE_DEST_n` parameter
- *Oracle Database Advanced Security Guide* for more information about transparent data encryption

## 17.7 GROUP

The `GROUP` attribute is used to specify membership in a specific collection of log archive destinations.

Groups are numbered 1 through 8. The default group (`GROUP=0`) is special in that it cannot be assigned. The default group is populated with all destinations that are not explicitly assigned to a group.

| Category                  | GROUP=integer  |
|---------------------------|----------------|
| Data Type                 | Integer        |
| Valid Value               | 1 through 8    |
| Default Value             | 0              |
| Requires Attributes       | SERVICE        |
| Conflicts with Attributes | ALTERNATE      |
| Corresponds to            | Not applicable |

### Usage Notes

- None

### Examples

The following example is given to illustrate basic concepts and is not meant to be used exactly as shown. Depending on your configuration, there may be other parameters, such as `DB_UNIQUE_NAME`, that are required.

```
LOG_ARCHIVE_DEST_1= 'SERVICE=FS1 GROUP=1'
LOG_ARCHIVE_DEST_2= 'SERVICE=FS2 GROUP=1'
LOG_ARCHIVE_DEST_3= 'SERVICE=FS3 GROUP=2'
LOG_ARCHIVE_DEST_4= 'SERVICE=FS4 GROUP=2'
```

 **See Also:**

- [Assigning Log Archive Destinations to a Group](#)



## 17.8 LOCATION and SERVICE

Each destination *must* specify either the `LOCATION` or the `SERVICE` attribute to identify either a local disk directory or a remote database destination where redo transport services can transmit redo data.

`LOG_ARCHIVE_DEST_1` through `LOG_ARCHIVE_DEST_10` destinations can contain either a `LOCATION` attribute or a `SERVICE` attribute.

`LOG_ARCHIVE_DEST_11` through `LOG_ARCHIVE_DEST_31` destinations can only contain a `SERVICE` attribute.

| Category                  | <code>LOCATION=local_disk_directory</code> or<br><code>USE_DB_RECOVERY_FILE_DEST</code>                                                                                                                               | <code>SERVICE=net_service_name</code>                                                                   |
|---------------------------|-----------------------------------------------------------------------------------------------------------------------------------------------------------------------------------------------------------------------|---------------------------------------------------------------------------------------------------------|
| Data type                 | String value                                                                                                                                                                                                          | String value                                                                                            |
| Valid values              | Not applicable                                                                                                                                                                                                        | Not applicable                                                                                          |
| Default Value             | None                                                                                                                                                                                                                  | None                                                                                                    |
| Requires attributes       | Not applicable                                                                                                                                                                                                        | Not applicable                                                                                          |
| Conflicts with attributes | <code>SERVICE</code> , <code>DELAY</code> , <code>NOREGISTER</code> ,<br><code>SYNC</code> , <code>ASYN</code> , <code>NET_TIMEOUT</code> ,<br><code>AFFIRM</code> , <code>NOAFFIRM</code> , <code>COMPRESSION</code> | <code>LOCATION</code>                                                                                   |
| Corresponds to            | <code>DESTINATION</code> and <code>TARGET</code> columns of<br>the <code>V\$ARCHIVE_DEST</code> view                                                                                                                  | <code>DESTINATION</code> and <code>TARGET</code><br>columns of the <code>V\$ARCHIVE_DEST</code><br>view |

### Usage Notes

- Either the `LOCATION` or the `SERVICE` attribute must be specified. There is no default.
- The `LOG_ARCHIVE_DEST_11` through `LOG_ARCHIVE_DEST_31` parameters do not support the `LOCATION` attribute.
- If you are specifying multiple attributes, specify the `LOCATION` or `SERVICE` attribute first in the list of attributes.
- You must specify at least one local disk directory with the `LOCATION` attribute. This ensures that local archived redo log files are accessible if media recovery of a database becomes necessary. You can specify up to thirty additional local or remote destinations.
- For the `LOCATION` attribute, you can specify one of the following:
  - `LOCATION= local_disk_directory`  
This specifies a unique directory path name for a disk directory on the system that hosts the database. This is the local destination for archived redo log files.
  - `LOCATION=USE_DB_RECOVERY_FILE_DEST`  
To configure a fast recovery area, specify the directory or Oracle Storage Manager disk group to serve as the fast recovery area using the `DB_RECOVERY_FILE_DEST` initialization parameter.
- When you specify a `SERVICE` attribute:

- You identify remote destinations by specifying the `SERVICE` attribute with a valid Oracle Net service name (`SERVICE= net_service_name`) that identifies the remote Oracle database instance to which the redo data is sent.

The Oracle Net service name that you specify with the `SERVICE` attribute is translated into a connection descriptor that contains the information necessary for connecting to the remote database.

#### See Also:

*Oracle Database Net Services Administrator's Guide* for details about setting up Oracle Net service names

- Transmitting redo data to a remote destination requires a network connection and an Oracle database instance associated with the remote destination to receive the incoming redo data.
- To verify the current settings for `LOCATION` and `SERVICE` attributes, query the `V$ARCHIVE_DEST` fixed view:
  - The `TARGET` column identifies if the destination is local or remote to the primary database.
  - The `DESTINATION` column identifies the values that were specified for a destination. For example, the destination parameter value specifies the Oracle Net service name identifying the remote Oracle instance where the archived redo log files are located.

### Examples

The following example shows how to specify the `LOCATION` attribute:

```
LOG_ARCHIVE_DEST_2='LOCATION=/disk1/oracle/oradata/payroll/arch/'
LOG_ARCHIVE_DEST_STATE_2=ENABLE
```

The following example shows how to specify the `SERVICE` attribute:

```
LOG_ARCHIVE_DEST_3='SERVICE=stby1'
LOG_ARCHIVE_DEST_STATE_3=ENABLE
```

## 17.9 MANDATORY

The `MANDATORY` attribute specifies that filled online log files must be successfully archived to the destination before they can be reused.

| Category                  | MANDATORY                                                            |
|---------------------------|----------------------------------------------------------------------|
| Data type                 | Keyword                                                              |
| Valid values              | Not applicable                                                       |
| Default value             | Not applicable                                                       |
| Requires attributes       | Not applicable                                                       |
| Conflicts with attributes | Optional                                                             |
| Corresponds to            | <code>BINDING</code> column of the <code>V\$ARCHIVE_DEST</code> view |

## Usage Notes

- The LOG\_ARCHIVE\_DEST\_11 through LOG\_ARCHIVE\_DEST\_31 parameters do not support the MANDATORY attribute.
- If MANDATORY is not specified, then, by default, the destination is considered to be optional.

At least one destination must succeed, even if all destinations are optional. If archiving to an optional destination fails, the online redo log file is still available for reuse and may be overwritten eventually. However, if the archival operation of a mandatory destination fails, online redo log files cannot be overwritten.

- The LOG\_ARCHIVE\_MIN\_SUCCEED\_DEST=*n* parameter (where *n* is an integer from 1 to 10) specifies the number of destinations that must archive successfully before online redo log files can be overwritten.

All MANDATORY destinations and optional local destinations contribute to satisfying the LOG\_ARCHIVE\_MIN\_SUCCEED\_DEST=*n* count. If the value set for the LOG\_ARCHIVE\_MIN\_SUCCEED\_DEST parameter is met, the online redo log file is available for reuse. For example, you can set the parameter as follows:

```
# Database must archive to at least two locations before
# overwriting the online redo log files.
LOG_ARCHIVE_MIN_SUCCEED_DEST = 2
```

- You must have at least one local destination, which you can declare MANDATORY or leave as optional.

At least one local destination is operationally treated as mandatory, because the minimum value for the LOG\_ARCHIVE\_MIN\_SUCCEED\_DEST parameter is 1.

- The failure of any mandatory destination makes the LOG\_ARCHIVE\_MIN\_SUCCEED\_DEST parameter irrelevant.
- The LOG\_ARCHIVE\_MIN\_SUCCEED\_DEST parameter value cannot be greater than the number of mandatory destinations plus the number of optional local destinations.
- The BINDING column of the V\$ARCHIVE\_DEST fixed view specifies how failure affects the archival operation

## Example

The following example shows the MANDATORY attribute:

```
LOG_ARCHIVE_DEST_1='LOCATION=/arch/dest MANDATORY'
LOG_ARCHIVE_DEST_STATE_1=ENABLE
LOG_ARCHIVE_DEST_3='SERVICE=denver MANDATORY'
LOG_ARCHIVE_DEST_STATE_3=ENABLE
```

## 17.10 MAX\_FAILURE

The MAX\_FAILURE attribute controls the consecutive number of times at a log switch that redo transport services attempts to reestablish communication and transmit redo data to a failed destination before the primary database gives up on the destination.

The MAX\_FAILURE attribute is handled differently in Oracle Database 12c Release 1 (12.1) and Oracle Database 12c Release 2 (12.2). It is important to understand the differences. See the Usage Notes below.

| Category                  | MAX_FAILURE=count                                                                                                                          |
|---------------------------|--------------------------------------------------------------------------------------------------------------------------------------------|
| Data type                 | Numeric                                                                                                                                    |
| Valid value               | >=0                                                                                                                                        |
| Default value             | For default group destinations the default value is 0. For non-default log archive destination group destinations, the default value is 1. |
| Requires attributes       | REOPEN                                                                                                                                     |
| Conflicts with attributes | None                                                                                                                                       |
| Corresponds to            | MAX_FAILURE, FAILURE_COUNT, and REOPEN_SECS columns of the V\$ARCHIVE_DEST view                                                            |

### Usage Notes for MAX\_FAILURE in Oracle Database 12c Release 2 (12.2)

- For redo destinations that use the new GROUP and PRIORITY attributes, if the error count reaches the value specified for the MAX\_FAILURE attribute, then the destination enters the ERROR state where it remains until it is found to be accessible. It is checked periodically depending on the value specified for the REOPEN attribute.
- For default destinations in log archive groups (those redo destinations that do not use the new GROUP and PRIORITY attributes), the behavior of the MAX\_FAILURE attribute is the same as it is in Oracle Database 12c Release 1 (12.1.0.1)

### Usage Notes for MAX\_FAILURE in Oracle Database 12c Release 1 (12.1)

- The MAX\_FAILURE attribute is optional. By default, there are an unlimited number of archival attempts to the failed destination.
- This attribute is useful for providing failure resolution for destinations to which you want to retry transmitting redo data after a failure, but not retry indefinitely.
- When you specify the MAX\_FAILURE attribute, you must also set the REOPEN attribute. Once the specified number of consecutive attempts at log switch is exceeded, the destination is treated as if the REOPEN attribute was not specified.
- You can view the failure count in the FAILURE\_COUNT column of the V\$ARCHIVE\_DEST fixed view. The related column REOPEN\_SECS identifies the REOPEN attribute value.

#### Note:

Once the failure count for the destination reaches the specified MAX\_FAILURE attribute value, the only way to reuse the destination is to set the LOG\_ARCHIVE\_DEST\_n parameter. This has the effect of resetting the failure count to zero (0).

- The failure count is reset to zero (0) whenever the destination is modified by an ALTER SYSTEM SET statement. This avoids the problem of setting the MAX\_FAILURE attribute to a value less than the current failure count value.
- Once the failure count is greater than or equal to the value set for the MAX\_FAILURE attribute, the REOPEN attribute value is implicitly set to zero, which causes redo

transport services to transport redo data to an alternate destination (defined with the `ALTERNATE` attribute) on the next archival operation.

- Redo transport services attempt to archive to the failed destination indefinitely if you do not specify the `MAX_FAILURE` attribute (or if you specify `MAX_FAILURE=0`), and you specify a nonzero value for the `REOPEN` attribute. If the destination has the `MANDATORY` attribute, the online redo log file is not reusable until it has been archived to this destination.
- For log archive destinations not configured as a preferred alternate, if the error count reaches the value specified for the `MAX_FAILURE` attribute, then the destination is disabled and there is no further access until the destination is manually reenabled.
- For log archive destinations configured as a preferred alternate, if the error count reaches the value specified for the `MAX_FAILURE` attribute, then the alternate destination is enabled and the failing destination is switched to the `ALTERNATE` state. Because this destination is a preferred alternate, it is checked periodically (depending on the value of the `REOPEN` attribute).
- For log archive destinations configured as a non-preferred alternate, if the error count reaches the value specified for the `MAX_FAILURE` attribute, then the destination is disabled and there is no further access until the destination is manually (re)enabled. Also, the previously preferred destination (currently unavailable and in the `ALTERNATE` state) remains in the `ALTERNATE` state and does not return to service until it is explicitly manually (re)enabled.

### Example

The following example allows redo transport services to try reconnecting up to three consecutive times at log switch to the failed destination, as long as each log switch is more than 5 seconds apart. If the archival operation fails after the third attempt, then the destination is treated as if the `REOPEN` attribute was not specified and the destination is marked as permanently failed until reset.

```
LOG_ARCHIVE_DEST_1='LOCATION=/arc_dest REOPEN=5 MAX_FAILURE=3'
LOG_ARCHIVE_DEST_STATE_1=ENABLE
```

## 17.11 NET\_TIMEOUT

The `NET_TIMEOUT` attribute specifies the number of seconds that the LGWR background process blocks waiting for a redo transport destination to acknowledge redo data sent to it.

If an acknowledgement is not received within `NET_TIMEOUT` seconds, an error is logged and the redo transport session to that destination is terminated.

| Category                  | <code>NET_TIMEOUT=seconds</code>                                                                                 |
|---------------------------|------------------------------------------------------------------------------------------------------------------|
| Data type                 | Numeric                                                                                                          |
| Valid values              | 1 <sup>1</sup> to 1200                                                                                           |
| Default value             | 30 seconds                                                                                                       |
| Requires attributes       | SYNC                                                                                                             |
| Conflicts with attributes | ASYN (If you specify the <code>ASYN</code> attribute, redo transport services ignores it; no error is returned.) |

| Category       | NET_TIMEOUT=seconds                                                    |
|----------------|------------------------------------------------------------------------|
| Corresponds to | NET_TIMEOUT column of the V\$ARCHIVE_DEST view of the primary database |

<sup>1</sup> Although a minimum value of 1 second is allowed, Oracle recommends a minimum value of 8 to 10 seconds to avoid disconnecting from the standby database due to transient network errors.

### Usage Notes

- The NET\_TIMEOUT attribute is optional. However, if you do not specify the NET\_TIMEOUT attribute it is set to 30 seconds, but the primary database can potentially stall. To avoid this situation, specify a small, nonzero value for the NET\_TIMEOUT attribute so the primary database can continue operation after the user-specified timeout interval expires when waiting for status from the network server.
- As of Oracle Database 12c Release 12.2 (12.2.0.1), there is a new database initialization parameter, DATA\_GUARD\_SYNC\_LATENCY, which is global for all synchronous standby destinations. It defines the maximum amount of time (in seconds) that the primary database may wait before disconnecting subsequent destinations after at least one synchronous standby has acknowledged receipt of the redo. See *Oracle Database Reference*.

### Example

The following example shows how to specify a 10-second network timeout value on the primary database with the NET\_TIMEOUT attribute.

```
LOG_ARCHIVE_DEST_2='SERVICE=stby1 SYNC NET_TIMEOUT=10'
LOG_ARCHIVE_DEST_STATE_2=ENABLE
```

## 17.12 NOREGISTER

The NOREGISTER attribute indicates that the location of the archived redo log file should not be recorded at the corresponding destination.

| Category                  | NOREGISTER                                                 |
|---------------------------|------------------------------------------------------------|
| Data type                 | Keyword                                                    |
| Valid values              | Not applicable                                             |
| Default value             | Not applicable                                             |
| Requires attributes       | SERVICE                                                    |
| Conflicts with attributes | LOCATION                                                   |
| Corresponds to            | DESTINATION and TARGET columns of the V\$ARCHIVE_DEST view |

### Usage Notes

- The NOREGISTER attribute *is optional* if the standby database destination is a part of an Oracle Data Guard configuration.
- The NOREGISTER attribute *is required* if the destination is not part of an Oracle Data Guard configuration.

- This attribute pertains to remote destinations only. The location of each archived redo log file is always recorded in the primary database control file.
- This attribute must not be used in an Oracle Data Guard configuration that has no downstream GoldenGate mining setup. Using `NOREGISTER` in this scenario may cause problems during switchover operations.

### Example

The following example shows the `NOREGISTER` attribute:

```
LOG_ARCHIVE_DEST_5='NOREGISTER'
```

## 17.13 PRIORITY

The `PRIORITY` attribute is used to specify preference within a collection of log archive destinations.

Priorities are numbered 1 through 8. A lower value represents a higher priority. The lowest priority (`PRIORITY=8`) is special in the sense that if that priority is active then all destinations at that priority are made active. If any higher priority destination returns to service, then that destination is made active and all low priority destinations are made inactive.

| Category                  | Priority= <i>integer</i> |
|---------------------------|--------------------------|
| Data Type                 | Integer                  |
| Valid Value               | 1 through 8              |
| Default Value             | 1                        |
| Requires attributes       | <code>SERVICE</code>     |
| Conflicts with attributes | <code>ALTERNATE</code>   |
| Corresponds to            | Not applicable           |

### Usage Notes

- The `PRIORITY` attribute is always used in conjunction with the `GROUP` attribute to provide an orderly enabling and fallback of members (redo destinations) of the group.

### Example

The following example is given to illustrate basic concepts and is not meant to be used exactly as shown. Depending on your configuration, there may be other parameters, such as `DB_UNIQUE_NAME`, that are required. A sample log archive destination setup that defines priorities is as follows:

```
LOG_ARCHIVE_DEST_1='SERVICE=FS1 SYNC GROUP=1 PRIORITY=1'
LOG_ARCHIVE_DEST_2='SERVICE=FS2 SYNC GROUP=1 PRIORITY=1'
LOG_ARCHIVE_DEST_3='SERVICE=FS3 ASYNC GROUP=1 PRIORITY=2'
LOG_ARCHIVE_DEST_4='SERVICE=TS ASYNC GROUP=1 PRIORITY=3'
```

This declaration results in the following behavior:

- The primary ships to either of two preferred far sync instances, `FS1` or `FS2`.

- If both `FS1` and `FS2` become unavailable, then the primary ships to `FS3` (in this case via `ASYNCR`).
- If either `FS1` or `FS2` become available while the primary is shipping to `FS3`, then the primary fails back to the available preferred log archive destination.
- If all three higher priority log archive destinations fail, the primary begins shipping to `TS` (Terminal Standby). While shipping to `TS`, if `FS1`, `FS2`, or `FS3` become available, then the primary switches to the newly available higher priority destination.



#### See Also:

- [Assigning Priorities to Log Archive Destinations in a Group](#)

## 17.14 REOPEN

The `REOPEN` attribute specifies the minimum number of seconds before redo transport services try to reopen a failed destination.

| Category                  | REOPEN [=seconds]                                                                                      |
|---------------------------|--------------------------------------------------------------------------------------------------------|
| Data Type                 | Numeric                                                                                                |
| Valid values              | >=0 seconds                                                                                            |
| Default Value             | 300 seconds                                                                                            |
| Requires attributes       | None                                                                                                   |
| Conflicts with attributes | Not applicable                                                                                         |
| Corresponds to            | <code>REOPEN_SECS</code> and <code>MAX_FAILURE</code> columns of the <code>V\$ARCHIVE_DEST</code> view |

### Usage Notes

- The `REOPEN` attribute is optional.
- Redo transport services attempt to reopen failed destinations at log switch time.
- Redo transport services check if the time of the last error plus the `REOPEN` interval is less than the current time. If it is, redo transport services attempt to reopen the destination.
- `REOPEN` applies to all errors, not just connection failures. These errors include, but are not limited to, network failures, disk errors, and quota exceptions.
- If you specify `REOPEN` for an optional destination, then it is possible for the Oracle database to overwrite online redo log files if there is an error. If you specify `REOPEN` for a `MANDATORY` destination, then redo transport services stall the primary database when it is not possible to successfully transmit redo data. When this situation occurs, consider the following options:
  - Change the destination by deferring the destination, specifying the destination as optional, or changing the `SERVICE` attribute value.
  - Specify an alternate destination.



- Disable the destination.

### Example

The following example shows the `REOPEN` attribute.

```
LOG_ARCHIVE_DEST_3='SERVICE=stby1 MANDATORY REOPEN=60'
LOG_ARCHIVE_DEST_STATE_3=ENABLE
```

## 17.15 SYNC and ASYNC

The `SYNC` and `ASYNC` attributes specify whether the synchronous (`SYNC`) or asynchronous (`ASYNC`) redo transport mode is to be used.

| Category                  | SYNC                                             | ASYNC                                            |
|---------------------------|--------------------------------------------------|--------------------------------------------------|
| Data type                 | Keyword                                          | Keyword                                          |
| Valid values              | Not applicable                                   | Not applicable                                   |
| Default value             | Not applicable                                   | None                                             |
| Requires attributes       | None                                             | None                                             |
| Conflicts with attributes | ASYNC, LOCATION                                  | SYNC, LOCATION                                   |
| Corresponds to            | TRANSMIT_MODE column of the V\$ARCHIVE_DEST view | TRANSMIT_MODE column of the V\$ARCHIVE_DEST view |

### Usage Notes

- The `LOG_ARCHIVE_DEST_11` through `LOG_ARCHIVE_DEST_31` parameters do not support the `SYNC` attribute.
- The redo data generated by a transaction must have been received by every enabled destination that has the `SYNC` attribute before that transaction can commit.
- On primary databases and logical standbys, destinations 1 through 10 default to `ASYNC` (real-time cascading).

On physical standbys, snapshot standbys, and far sync instances, destinations 1 through 10 default to `ARCH` transport mode. (Note that the `ARCH` attribute is deprecated; the use of `ARCH` in this situation simply indicates non-real-time cascading.)

Destinations 11 through 31 always default to `ASYNC`.

### See Also:

- *Oracle Database Reference* for more information about `LOG_ARCHIVE_DEST_n` deprecated attributes

### Example

The following example shows the `SYNC` attribute with the `LOG_ARCHIVE_DEST_n` parameter.

```
LOG_ARCHIVE_DEST_3='SERVICE=stby1 SYNC'
LOG_ARCHIVE_DEST_STATE_3=ENABLE
```

## 17.16 TEMPLATE

The `TEMPLATE` attribute defines a directory specification and format template for names of archived redo log files at the destination.

The template is used to generate a filename that is different from the default filename format defined by the `LOG_ARCHIVE_FORMAT` initialization parameter at the redo destination.

| Category                      | TEMPLATE=filename_template_%t_%s_%r                              |
|-------------------------------|------------------------------------------------------------------|
| Data Type                     | String value                                                     |
| Valid values                  | Not applicable                                                   |
| Default value                 | None                                                             |
| Requires attributes ...       | SERVICE                                                          |
| Conflicts with attributes ... | LOCATION                                                         |
| Corresponds to ...            | REMOTE_TEMPLATE and REGISTER columns of the V\$ARCHIVE_DEST view |

### Usage Notes

- The `TEMPLATE` attribute is optional. If `TEMPLATE` is not specified, archived redo logs are named using the value of the `LOG_ARCHIVE_FORMAT` initialization parameter.
- The `TEMPLATE` attribute overrides the `LOG_ARCHIVE_FORMAT` initialization parameter setting at the remote archival destination.
- The `TEMPLATE` attribute is valid only with remote destinations (specified with the `SERVICE` attribute).
- The value you specify for `filename_template` must contain the `%s`, `%t`, and `%r` directives described in [Table 17-1](#).

**Table 17-1 Directives for the TEMPLATE Attribute**

| Directive       | Description                                           |
|-----------------|-------------------------------------------------------|
| <code>%t</code> | Substitute the instance thread number.                |
| <code>%T</code> | Substitute the instance thread number, zero filled.   |
| <code>%s</code> | Substitute the log file sequence number.              |
| <code>%S</code> | Substitute the log file sequence number, zero filled. |
| <code>%r</code> | Substitute the resetlogs ID.                          |
| <code>%R</code> | Substitute the resetlogs ID, zero filled.             |

- The `filename_template` value is transmitted to the destination, where it is translated and validated before creating the filename.

## 17.17 VALID\_FOR

The `VALID_FOR` attribute specifies whether redo data gets written to a destination.

The following factors are considered:

- Whether the database is *currently* running in the primary or the standby role
- Whether online redo log files, standby redo log files, or both are *currently* being archived on the database at this destination

| Category                  | <code>VALID_FOR=(redo_log_type, database_role)</code>                                                                           |
|---------------------------|---------------------------------------------------------------------------------------------------------------------------------|
| Data Type                 | String value                                                                                                                    |
| Valid values              | Not applicable                                                                                                                  |
| Default Value             | <code>VALID_FOR=(ALL_LOGFILES, ALL_ROLES)</code>                                                                                |
| Requires attributes       | None                                                                                                                            |
| Conflicts with attributes | None                                                                                                                            |
| Corresponds to            | <code>VALID_NOW</code> , <code>VALID_TYPE</code> , and <code>VALID_ROLE</code> columns in the <code>V\$ARCHIVE_DEST</code> view |

### Usage Notes

- The `VALID_FOR` attribute is optional. However, Oracle recommends that the `VALID_FOR` attribute be specified for each redo transport destination at each database in an Oracle Data Guard configuration so that redo transport continues after a role transition to any standby database in the configuration.
- To configure these factors for each `LOG_ARCHIVE_DEST_n` destination, you specify this attribute with a pair of keywords: `VALID_FOR=(redo_log_type, database_role)`:
  - The `redo_log_type` keyword identifies the destination as valid for archiving one of the following:
    - \* `ONLINE_LOGFILE`—This destination is valid only when archiving online redo log files.
    - \* `STANDBY_LOGFILE`—This destination is valid only when archiving standby redo log files.
    - \* `ALL_LOGFILES`— This destination is valid when archiving either online redo log files or standby redo log files.
  - The `database_role` keyword identifies the role in which this destination is valid for archiving:
    - \* `PRIMARY_ROLE`—This destination is valid only when the database is running in the primary role.
    - \* `STANDBY_ROLE`—This destination is valid only when the database is running in the standby role.
    - \* `ALL_ROLES`—This destination is valid when the database is running in either the primary or the standby role.
- If you do not specify the `VALID_FOR` attribute for a destination, by default, archiving online redo log files and standby redo log files is enabled at the destination, regardless of whether the database is running in the primary or the standby

role. This default behavior is equivalent to setting the `(ALL_LOGFILES,ALL_ROLES)` keyword pair on the `VALID_FOR` attribute.

- The `VALID_FOR` attribute enables you to use the same initialization parameter file for both the primary and standby roles.

### Example

The following example shows the default `VALID_FOR` keyword pair:

```
LOG_ARCHIVE_DEST_1='LOCATION=/disk1/oracle/oradata VALID_FOR=(ALL_LOGFILES, ALL_ROLES)'
```

When this database is running in either the primary or standby role, destination 1 archives all log files to the `/disk1/oracle/oradata` local directory location.

# 18

## SQL Statements Relevant to Oracle Data Guard

There are many SQL and SQL\*Plus statements that are useful for performing operations on standby databases in an Oracle Data Guard environment.

See the following topics:

- [ALTER DATABASE Statements](#)
- [ALTER SESSION Statements](#)
- [ALTER SYSTEM Statements](#)

Refer to the *Oracle Database SQL Language Reference* for complete syntax and descriptions of all SQL statements.

See [Initialization Parameters](#) for a list of initialization parameters that you can set and dynamically update using the `ALTER SYSTEM SET` statement.

### 18.1 ALTER DATABASE Statements

This table describes `ALTER DATABASE` statements that are relevant to Oracle Data Guard.

**Table 18-1 ALTER DATABASE Statements Used in Data Guard Environments**

| ALTER DATABASE Statement                                                                          | Description                                                                                                                                                                                                                                                                                                                                                                                                                                                                                                                                                                                                                                                                                                                                                                                                                 |
|---------------------------------------------------------------------------------------------------|-----------------------------------------------------------------------------------------------------------------------------------------------------------------------------------------------------------------------------------------------------------------------------------------------------------------------------------------------------------------------------------------------------------------------------------------------------------------------------------------------------------------------------------------------------------------------------------------------------------------------------------------------------------------------------------------------------------------------------------------------------------------------------------------------------------------------------|
| <code>ACTIVATE [PHYSICAL LOGICAL] STANDBY DATABASE FINISH APPLY]</code>                           | <p>Performs a failover. The standby database must be mounted before it can be activated with this statement.</p> <p><b>Note:</b> Do not use the <code>ALTER DATABASE ACTIVATE STANDBY DATABASE</code> statement to failover because it causes data loss. Instead, use the following best practices:</p> <ul style="list-style-type: none"><li>• For physical standby databases, use the <code>ALTER DATABASE RECOVER MANAGED STANDBY DATABASE</code> statement with the <code>FINISH</code> keyword to perform the role transition as quickly as possible with little or no data loss and without rendering other standby databases unusable.</li><li>• For logical standby databases, use the <code>ALTER DATABASE PREPARE TO SWITCHOVER</code> and <code>ALTER DATABASE COMMIT TO SWITCHOVER</code> statements.</li></ul> |
| <code>ADD [STANDBY] LOGFILE [THREAD <i>integer</i>] [GROUP <i>integer</i>] <i>filespec</i></code> | <p>Adds one or more online redo log file groups or standby redo log file groups to the specified thread, making the log files available to the instance to which the thread is assigned.</p> <p>See <a href="#">Add or Drop a Redo Log File Group</a> for an example of this statement.</p>                                                                                                                                                                                                                                                                                                                                                                                                                                                                                                                                 |
| <code>ADD [STANDBY] LOGFILE MEMBER '<i>filename</i>' [REUSE] TO <i>logfile-descriptor</i></code>  | <p>Adds new members to existing online redo log file groups or standby redo log file groups.</p>                                                                                                                                                                                                                                                                                                                                                                                                                                                                                                                                                                                                                                                                                                                            |

Table 18-1 (Cont.) ALTER DATABASE Statements Used in Data Guard Environments

| ALTER DATABASE Statement                                                     | Description                                                                                                                                                                                                                                                                                                                                                                                                                                                                                                                                                                                                                                                                                                                                                                                                                                                                                                                                                                                         |
|------------------------------------------------------------------------------|-----------------------------------------------------------------------------------------------------------------------------------------------------------------------------------------------------------------------------------------------------------------------------------------------------------------------------------------------------------------------------------------------------------------------------------------------------------------------------------------------------------------------------------------------------------------------------------------------------------------------------------------------------------------------------------------------------------------------------------------------------------------------------------------------------------------------------------------------------------------------------------------------------------------------------------------------------------------------------------------------------|
| [ADD DROP] SUPPLEMENTAL LOG DATA {PRIMARY KEY UNIQUE INDEX} COLUMNS          | This statement is for logical standby databases only. Use it to enable full supplemental logging before you create a logical standby database. This is necessary because supplemental logging is the source of change to a logical standby database. To implement full supplemental logging, you must specify either the PRIMARY KEY COLUMNS or the UNIQUE INDEX COLUMNS keyword on this statement.                                                                                                                                                                                                                                                                                                                                                                                                                                                                                                                                                                                                 |
| COMMIT TO SWITCHOVER                                                         | Performs a switchover to: <ul style="list-style-type: none"> <li>Change the current primary database to the standby database role</li> <li>Change one standby database to the primary database role.</li> </ul> <p>When switching over to a physical standby database, as of Oracle Database 12c Release 1 (12.1), the COMMIT TO SWITCHOVER statement has been replaced with the SWITCHOVER TO statement. The COMMIT TO SWITCHOVER statement is still supported, but Oracle recommends that you use the new SWITCHOVER TO statement.</p> <p><b>Note:</b> On logical standby databases, you issue the ALTER DATABASE PREPARE TO SWITCHOVER statement to prepare the database for the switchover before you issue the ALTER DATABASE COMMIT TO SWITCHOVER statement.</p> <p>See <a href="#">Performing a Switchover to a Physical Standby Database Using Old Syntax</a> and <a href="#">Performing a Failover to a Physical Standby Database Using Old Syntax</a> for examples of this statement.</p> |
| CONVERT TO [[PHYSICAL SNAPSHOT] STANDBY] DATABASE                            | Converts a physical standby database into a snapshot standby database and vice versa.                                                                                                                                                                                                                                                                                                                                                                                                                                                                                                                                                                                                                                                                                                                                                                                                                                                                                                               |
| CREATE [PHYSICAL LOGICAL] STANDBY CONTROLFILE AS ' <i>filename</i> ' [REUSE] | Creates a control file to be used to maintain a physical or a logical standby database. Issue this statement on the primary database. See <a href="#">Create a Control File for the Standby Database</a> for an example of this statement.                                                                                                                                                                                                                                                                                                                                                                                                                                                                                                                                                                                                                                                                                                                                                          |
| DROP [STANDBY] LOGFILE <i>logfile_descriptor</i>                             | Drops all members of an online redo log file group or standby redo log file group. See <a href="#">Add or Drop a Redo Log File Group</a> for an example of this statement.                                                                                                                                                                                                                                                                                                                                                                                                                                                                                                                                                                                                                                                                                                                                                                                                                          |
| DROP [STANDBY] LOGFILE MEMBER ' <i>filename</i> '                            | Drops one or more online redo log file members or standby redo log file members.                                                                                                                                                                                                                                                                                                                                                                                                                                                                                                                                                                                                                                                                                                                                                                                                                                                                                                                    |
| FAILOVER TO <i>target_db_name</i>                                            | This statement is for physical standby databases only. It initiates a failover to the specified host database.                                                                                                                                                                                                                                                                                                                                                                                                                                                                                                                                                                                                                                                                                                                                                                                                                                                                                      |
| [NO]FORCE LOGGING                                                            | Controls whether or not the Oracle database logs all changes in the database except for changes to temporary tablespaces and temporary segments. The [NO]FORCE LOGGING clause is required to prevent inconsistent standby databases. The primary database must at least be mounted (and it can also be open) when you issue this statement. See <a href="#">Enable Forced Logging</a> for an example of this statement.                                                                                                                                                                                                                                                                                                                                                                                                                                                                                                                                                                             |

Table 18-1 (Cont.) ALTER DATABASE Statements Used in Data Guard Environments

| ALTER DATABASE Statement                                                                                                    | Description                                                                                                                                                                                                                                                                                                                                                                                                                                                                                                                                                                           |
|-----------------------------------------------------------------------------------------------------------------------------|---------------------------------------------------------------------------------------------------------------------------------------------------------------------------------------------------------------------------------------------------------------------------------------------------------------------------------------------------------------------------------------------------------------------------------------------------------------------------------------------------------------------------------------------------------------------------------------|
| GUARD                                                                                                                       | Controls user access to tables in a logical standby database. Possible values are ALL, STANDBY, and NONE. See <a href="#">Controlling User Access to Tables in a Logical Standby Database</a> for more information.                                                                                                                                                                                                                                                                                                                                                                   |
| MOUNT [STANDBY DATABASE]                                                                                                    | Mounts a standby database, allowing the standby instance to receive redo data from the primary instance.                                                                                                                                                                                                                                                                                                                                                                                                                                                                              |
| OPEN                                                                                                                        | Opens a previously started and mounted database: <ul style="list-style-type: none"> <li>Physical standby databases are opened in read-only mode, restricting users to read-only transactions and preventing the generating of redo data.</li> <li>Logical standby database are opened in read/write mode.</li> </ul>                                                                                                                                                                                                                                                                  |
| PREPARE TO SWITCHOVER                                                                                                       | This statement is for logical standby databases only. It prepares the primary database and the logical standby database for a switchover by building the LogMiner dictionary <i>before</i> the switchover takes place. After the dictionary build has completed, issue the ALTER DATABASE COMMIT TO SWITCHOVER statement to switch the roles of the primary and logical standby databases. See <a href="#">Performing a Switchover to a Logical Standby Database</a> for examples of this statement.                                                                                  |
| RECOVER MANAGED STANDBY DATABASE<br>[ { DISCONNECT [FROM SESSION]  <br>PARALLEL n   NODELAY   UNTIL CHANGE<br>integer }...] | This statement starts and controls Redo Apply on physical standby databases. You can use the RECOVER MANAGED STANDBY DATABASE clause on a physical standby database that is mounted, open, or closed. See Step 3 in <a href="#">Start the Physical Standby Database</a> and <a href="#">Applying Redo Data to Physical Standby Databases</a> for examples.<br><br><b>Note:</b> Several clauses and keywords were deprecated and are supported for backward compatibility only. See <i>Oracle Database SQL Language Reference</i> for more information about these deprecated clauses. |
| RECOVER MANAGED STANDBY DATABASE CANCEL                                                                                     | The CANCEL clause cancels Redo Apply on a physical standby database after applying the current archived redo log file.<br><br><b>Note:</b> Several clauses and keywords were deprecated and are supported for backward compatibility only. See <i>Oracle Database SQL Language Reference</i> for more information about these clauses.                                                                                                                                                                                                                                                |
| RECOVER MANAGED STANDBY DATABASE FINISH                                                                                     | The FINISH clause initiates failover on the target physical standby database and recovers the current standby redo log files. Use the FINISH clause only in the event of the failure of the primary database. This clause overrides any delay intervals specified.<br><br><b>Note:</b> Several clauses and keywords were deprecated and are supported for backward compatibility only. See <i>Oracle Database SQL Language Reference</i> for more information about these clauses.                                                                                                    |

**Table 18-1 (Cont.) ALTER DATABASE Statements Used in Data Guard Environments**

| ALTER DATABASE Statement                                                              | Description                                                                                                                                                                                                                                                                                                                                                                      |
|---------------------------------------------------------------------------------------|----------------------------------------------------------------------------------------------------------------------------------------------------------------------------------------------------------------------------------------------------------------------------------------------------------------------------------------------------------------------------------|
| REGISTER [OR REPLACE] [PHYSICAL LOGICAL] LOGFILE <i>filespec</i>                      | Allows the registration of manually copied archived redo log files.<br><b>Note:</b> Issue this command only after manually copying the corresponding archived redo log file to the standby database. Issuing this command while the log file is in the process of being copied or when the log file does not exist may result in errors on the standby database at a later time. |
| RECOVER TO LOGICAL STANDBY <i>new_database_name</i>                                   | Instructs apply services to continue applying changes to the <i>physical</i> standby database until you issue the command to convert the database to a <i>logical</i> standby database. See <a href="#">Convert to a Logical Standby Database</a> for more information.                                                                                                          |
| RESET DATABASE TO INCARNATION <i>integer</i>                                          | Resets the target recovery incarnation for the database from the current incarnation to a different incarnation.                                                                                                                                                                                                                                                                 |
| SET STANDBY DATABASE TO MAXIMIZE {PROTECTION AVAILABILITY PERFORMANCE}                | Use this clause to specify the level of protection for the data in your Oracle Data Guard configuration. You specify this clause from the primary database.                                                                                                                                                                                                                      |
| START LOGICAL STANDBY APPLY INITIAL [ <i>scn-value</i> ] [NEW PRIMARY <i>dblink</i> ] | This statement is for logical standby databases only. It starts SQL Apply on a logical standby database. See <a href="#">Starting SQL Apply</a> for examples of this statement.                                                                                                                                                                                                  |
| {STOP ABORT} LOGICAL STANDBY APPLY                                                    | This statement is for logical standby databases only. Use the STOP clause to stop SQL Apply on a logical standby database in an orderly fashion. Use the ABORT clause to stop SQL Apply abruptly. See <a href="#">Performing a Failover to a Logical Standby Database</a> for an example of this statement.                                                                      |
| SWITCHOVER TO <i>target_db_name</i>                                                   | This statement is for physical standby databases only. It initiates a switchover on the primary database to the specified physical standby database.                                                                                                                                                                                                                             |

## 18.2 ALTER SESSION Statements

This table describes the ALTER SESSION statements that are relevant to Oracle Data Guard.

**Table 18-2 ALTER SESSION Statements Used in Oracle Data Guard Environments**

| ALTER SESSION Statement              | Description                                                                                                                                                                                                                                |
|--------------------------------------|--------------------------------------------------------------------------------------------------------------------------------------------------------------------------------------------------------------------------------------------|
| ALTER SESSION [ENABLE DISABLE] GUARD | This statement is for logical standby databases only. This statement allows privileged users to turn the database guard on and off for the current session. See <a href="#">Modifying a Logical Standby Database</a> for more information. |



**Table 18-2 (Cont.) ALTER SESSION Statements Used in Oracle Data Guard Environments**

| ALTER SESSION Statement         | Description                                                                                                                                                                                                                                                                                                                                                                          |
|---------------------------------|--------------------------------------------------------------------------------------------------------------------------------------------------------------------------------------------------------------------------------------------------------------------------------------------------------------------------------------------------------------------------------------|
| ALTER SESSION SYNC WITH PRIMARY | This statement is for physical standby databases only.<br>This statement synchronizes a physical standby database with the primary database, by blocking until all redo data received by the physical standby at the time of statement invocation has been applied.<br>See <a href="#">Forcing Redo Apply Synchronization in a Real-time Query Environment</a> for more information. |

## 18.3 ALTER SYSTEM Statements

This table describes the ALTER SYSTEM statements that are relevant to Oracle Data Guard.

**Table 18-3 ALTER SYSTEM Statements Used in Oracle Data Guard Environments**

| ALTER SYSTEM Statement                                            | Description                                                                                                                                                                                                                                                           |
|-------------------------------------------------------------------|-----------------------------------------------------------------------------------------------------------------------------------------------------------------------------------------------------------------------------------------------------------------------|
| ALTER SYSTEM FLUSH REDO TO<br>target_db_name [[NO] CONFIRM APPLY] | This statement flushes redo data from a primary database to a standby database and optionally waits for the flushed redo data to be applied to a physical or logical standby database.<br>This statement must be issued on a mounted, but not open, primary database. |

# 19

## Views Relevant to Oracle Data Guard

There are a number of views that are especially useful when monitoring an Oracle Data Guard environment.

[Table 19-1](#) describes the views and indicates if a view applies to physical standby databases, logical standby databases, snapshot standby databases, or primary databases. See *Oracle Database Reference* for complete information about views.

**Table 19-1 Views That Are Pertinent to Oracle Data Guard Configurations**

| View                          | Database                                 | Description                                                                                                                                                                                                                                                                                                                                                                                           |
|-------------------------------|------------------------------------------|-------------------------------------------------------------------------------------------------------------------------------------------------------------------------------------------------------------------------------------------------------------------------------------------------------------------------------------------------------------------------------------------------------|
| DBA_LOGSTDBY_EVENTS           | Logical only                             | Contains information about the activity of a logical standby database. It can be used to determine the cause of failures that occur when SQL Apply is applying redo to a logical standby database.                                                                                                                                                                                                    |
| DBA_LOGSTDBY_HISTORY          | Logical only                             | Displays the history of switchovers and failovers for logical standby databases in an Oracle Data Guard configuration. It does this by showing the complete sequence of redo log streams processed or created on the local system, across all role transitions. (After a role transition, a new log stream is started and the log stream sequence number is incremented by the new primary database.) |
| DBA_LOGSTDBY_LOG              | Logical only                             | Shows the log files registered for logical standby databases.                                                                                                                                                                                                                                                                                                                                         |
| DBA_LOGSTDBY_NOT_UNIQUE       | Logical only                             | Identifies tables that have no primary and no non-null unique indexes.                                                                                                                                                                                                                                                                                                                                |
| DBA_LOGSTDBY_PARAMETERS       | Logical only                             | Contains the list of parameters used by SQL Apply.                                                                                                                                                                                                                                                                                                                                                    |
| DBA_LOGSTDBY_SKIP             | Logical only                             | Lists the tables to be skipped by SQL Apply.                                                                                                                                                                                                                                                                                                                                                          |
| DBA_LOGSTDBY_SKIP_TRANSACTION | Logical only                             | Lists the skip settings chosen.                                                                                                                                                                                                                                                                                                                                                                       |
| DBA_LOGSTDBY_UNSUPPORTED      | Logical only                             | Identifies the schemas and tables (and columns in those tables) that contain unsupported data types. Use this view when you are preparing to create a logical standby database.                                                                                                                                                                                                                       |
| DBA_ROLLING_UNSUPPORTED       | Logical only                             | Displays the schemas, tables, and columns in those tables, that contain unsupported data types for a rolling upgrade operation for a logical standby database using the DBMS_ROLLING PL/SQL package. Use this view before you perform a rolling upgrade using DBMS_ROLLING to determine what is unsupported.                                                                                          |
| V\$ARCHIVE_DEST               | Primary, physical, snapshot, and logical | Describes all of the destinations in the Oracle Data Guard configuration, including each destination's current value, mode, and status.<br><b>Note:</b> The information in this view does not persist across an instance shutdown.                                                                                                                                                                    |
| V\$ARCHIVE_DEST_STATUS        | Primary, physical, snapshot, and logical | Displays runtime and configuration information for the archived redo log destinations.<br><b>Note:</b> The information in this view does not persist across an instance shutdown.                                                                                                                                                                                                                     |

**Table 19-1 (Cont.) Views That Are Pertinent to Oracle Data Guard Configurations**

| View                    | Database                                 | Description                                                                                                                                                                                                                                                                                                                         |
|-------------------------|------------------------------------------|-------------------------------------------------------------------------------------------------------------------------------------------------------------------------------------------------------------------------------------------------------------------------------------------------------------------------------------|
| V\$ARCHIVE_GAP          | Physical, snapshot, and logical          | Displays information to help you identify a gap in the archived redo log files.                                                                                                                                                                                                                                                     |
| V\$ARCHIVED_LOG         | Primary, physical, snapshot, and logical | Displays archive redo log information from the control file, including names of the archived redo log files.                                                                                                                                                                                                                        |
| V\$DATABASE             | Primary, physical, snapshot, and logical | Provides database information from the control file. Includes information about fast-start failover (available only with the Oracle Data Guard broker).                                                                                                                                                                             |
| V\$DATABASE_INCARNATION | Primary, physical, snapshot, and logical | Displays information about all database incarnations. Oracle Database creates a new incarnation whenever a database is opened with the RESETLOGS option. Records about the current and the previous incarnation are also contained in the V\$DATABASE view.                                                                         |
| V\$DATAFILE             | Primary, physical, snapshot, and logical | Provides data file information from the control file.                                                                                                                                                                                                                                                                               |
| V\$DATAGUARD_CONFIG     | Primary, physical, snapshot, and logical | Lists the unique database names defined with the DB_UNIQUE_NAME and LOG_ARCHIVE_CONFIG initialization parameters.                                                                                                                                                                                                                   |
| V\$DATAGUARD_STATS      | Primary, physical, snapshot, and logical | Displays various Oracle Data Guard statistics, including apply lag and transport lag. This view can be queried on any instance of a standby database. No rows are returned if queried on a primary database. See also <a href="#">Choosing a Target Standby Database for a Role Transition</a> for an example and more information. |
| V\$DATAGUARD_STATUS     | Primary, physical, snapshot, and logical | Displays and records events that would typically be triggered by any message to the alert log or server process trace files.                                                                                                                                                                                                        |
| V\$FS_FAILOVER_STATS    | Primary                                  | Displays statistics about fast-start failover occurring on the system.                                                                                                                                                                                                                                                              |
| V\$LOG                  | Primary, physical, snapshot, and logical | Contains log file information from the online redo log files.                                                                                                                                                                                                                                                                       |
| V\$LOGFILE              | Primary, physical, snapshot, and logical | Contains information about the online redo log files and standby redo log files.                                                                                                                                                                                                                                                    |
| V\$LOG_HISTORY          | Primary, physical, snapshot, and logical | Contains log history information from the control file.                                                                                                                                                                                                                                                                             |

**Table 19-1 (Cont.) Views That Are Pertinent to Oracle Data Guard Configurations**

| View                        | Database                        | Description                                                                                                                                                                                                                                                                                                                                                           |
|-----------------------------|---------------------------------|-----------------------------------------------------------------------------------------------------------------------------------------------------------------------------------------------------------------------------------------------------------------------------------------------------------------------------------------------------------------------|
| V\$LOGSTDBY_PROCESS         | Logical only                    | Provides dynamic information about what is happening with SQL Apply. This view is very helpful when you are diagnosing performance problems during SQL Apply on the logical standby database, and it can be helpful for other problems.                                                                                                                               |
| V\$LOGSTDBY_PROGRESS        | Logical only                    | Displays the progress of SQL Apply on the logical standby database.                                                                                                                                                                                                                                                                                                   |
| V\$LOGSTDBY_STATE           | Logical only                    | Consolidates information from the V\$LOGSTDBY_PROCESS and V\$LOGSTDBY_STATS views about the running state of SQL Apply and the logical standby database.                                                                                                                                                                                                              |
| V\$LOGSTDBY_STATS           | Logical only                    | Displays LogMiner statistics, current state, and status information for a logical standby database during SQL Apply. If SQL Apply is not running, the values for the statistics are cleared.                                                                                                                                                                          |
| V\$LOGSTDBY_TRANSACTION     | Logical only                    | Displays information about all active transactions being processed by SQL Apply on the logical standby database.                                                                                                                                                                                                                                                      |
| V\$MANAGED_STANDBY          | Physical and snapshot           | Displays current status information for Oracle database processes related to physical standby databases.<br><b>Note:</b> The information in this view does not persist across an instance shutdown.                                                                                                                                                                   |
| V\$REDO_DEST_RESP_HISTOGRAM | Primary                         | Contains the response time information for destinations that are configured for SYNC transport.<br><b>Note:</b> The information in this view does not persist across an instance shutdown.                                                                                                                                                                            |
| V\$STANDBY_EVENT_HISTOGRAM  | Physical                        | Contains a histogram of apply lag values for the physical standby. An entry is made in the corresponding apply lag bucket by the Redo Apply process every second. (This view returns rows only on a physical standby database that has been open in real-time query mode.)<br><b>Note:</b> The information in this view does not persist across an instance shutdown. |
| V\$STANDBY_LOG              | Physical, snapshot, and logical | Contains log file information from the standby redo log files.                                                                                                                                                                                                                                                                                                        |

# Part III

## Appendixes

This part contains the following appendixes:

- [Troubleshooting Oracle Data Guard](#)
- [Upgrading and Downgrading Databases in an Oracle Data Guard Configuration](#)
- [Data Type and DDL Support on a Logical Standby Database](#)
- [Oracle Data Guard and Oracle Real Application Clusters](#)
- [Creating a Standby Database with Recovery Manager](#)
- [Setting Archive Tracing](#)
- [Performing Role Transitions Using Old Syntax](#)
- [Using the ALTERNATE Attribute to Configure Remote Alternate Destinations](#)

# A

## Troubleshooting Oracle Data Guard

These are some of the problems that can occur on a standby database, and the troubleshooting procedures to address them.

- [Common Problems](#)
- [Log File Destination Failures](#)
- [Handling Logical Standby Database Failures](#)
- [Problems Switching Over to a Physical Standby Database](#)
- [Problems Switching Over to a Logical Standby Database](#)
- [What to Do If SQL Apply Stops](#)
- [Network Tuning for Redo Data Transmission](#)
- [Slow Disk Performance on Standby Databases](#)
- [Log Files Must Match to Avoid Primary Database Shutdown](#)
- [Troubleshooting a Logical Standby Database](#)

### A.1 Common Problems

These are some of the common problems you may encounter when using a standby database.

- [Renaming Data Files with the ALTER DATABASE Statement](#)
- [Standby Database Does Not Receive Redo Data from the Primary Database](#)
- [You Cannot Mount the Physical Standby Database](#)

#### A.1.1 Renaming Data Files with the ALTER DATABASE Statement

You cannot rename the data file on the standby site when the `STANDBY_FILE_MANAGEMENT` initialization parameter is set to `AUTO`.

When you set the `STANDBY_FILE_MANAGEMENT` initialization parameter to `AUTO`, use of the following SQL statements is not allowed:

- `ALTER DATABASE RENAME`
- `ALTER DATABASE ADD/DROP LOGFILE`
- `ALTER DATABASE ADD/DROP STANDBY LOGFILE MEMBER`
- `ALTER DATABASE CREATE DATAFILE AS`

If you attempt to use any of these statements on the standby database, an error is returned. For example:

```
SQL> ALTER DATABASE RENAME FILE '/disk1/oracle/oradata/payroll/t_db2.log' to 'dummy';  
alter database rename file '/disk1/oracle/oradata/payroll/t_db2.log' to 'dummy'
```

```
*
ERROR at line 1:
ORA-01511: error in renaming log/datafiles
ORA-01270: RENAME operation is not allowed if STANDBY_FILE_MANAGEMENT is auto
```

See [Adding a Data File or Creating a Tablespace](#) to learn how to add data files to a physical standby database.

## A.1.2 Standby Database Does Not Receive Redo Data from the Primary Database

If the standby site is not receiving redo data, query the `V$ARCHIVE_DEST` view and check for error messages.

For example, enter the following query:

```
SQL> SELECT DEST_ID "ID", -
> STATUS "DB_status", -
> DESTINATION "Archive_dest", -
> ERROR "Error" -
> FROM V$ARCHIVE_DEST WHERE DEST_ID <=5;
```

| ID | DB_status | Archive_dest                   | Error                                                      |
|----|-----------|--------------------------------|------------------------------------------------------------|
| 1  | VALID     | /vobs/oracle/work/arc_dest/arc |                                                            |
| 2  | ERROR     | standby1                       | ORA-16012: Archivelog standby database identifier mismatch |
| 3  | INACTIVE  |                                |                                                            |
| 4  | INACTIVE  |                                |                                                            |
| 5  | INACTIVE  |                                |                                                            |

5 rows selected.

If the output of the query does not help you, then check the following list of possible issues. If any of the following conditions exist, then redo transport services fail to transmit redo data to the standby database:

- The service name for the standby instance is not configured correctly in the `tnsnames.ora` file for the primary database.
- The Oracle Net service name specified by the `LOG_ARCHIVE_DEST_n` parameter for the primary database is incorrect.
- The `LOG_ARCHIVE_DEST_STATE_n` parameter for the standby database is not set to the value `ENABLE`.
- The `listener.ora` file has not been configured correctly for the standby database.
- The listener is not started at the standby site.
- The standby instance is not started.
- You have added a standby archiving destination to the primary `SPFILE` or text initialization parameter file, but have not yet enabled the change.
- Redo transport authentication has not been configured properly. See section 3.1.2 for redo transport authentication configuration requirements.
- You used an invalid backup as the basis for the standby database (for example, you used a backup from the wrong database, or did not create the standby control file using the correct method).

## A.1.3 You Cannot Mount the Physical Standby Database

You cannot mount the standby database if the standby control file was not created with the `ALTER DATABASE CREATE [LOGICAL] STANDBY CONTROLFILE ...` statement or RMAN command.

You cannot use the following types of control file backups:

- An operating system-created backup
- A backup created using an `ALTER DATABASE` statement *without* the `PHYSICAL STANDBY` or `LOGICAL STANDBY` option

## A.2 Log File Destination Failures

If you specify `REOPEN` for a `MANDATORY` destination, redo transport services stall the primary database when redo data cannot be successfully transmitted.

The `REOPEN` attribute is required when you use the `MAX_FAILURE` attribute. [Example A-1](#) shows how to set a retry time of 5 seconds and limit retries to 3 times.

### Example A-1 Setting a Retry Time and Limit

```
LOG_ARCHIVE_DEST_1='LOCATION=/arc_dest REOPEN=5 MAX_FAILURE=3'
```

Use the `ALTERNATE` attribute of the `LOG_ARCHIVE_DEST_n` parameter to specify alternate archive destinations. An alternate archiving destination can be used when the transmission of redo data to a standby database fails. If transmission fails and the `REOPEN` attribute was not specified or the `MAX_FAILURE` attribute threshold was exceeded, redo transport services attempts to transmit redo data to the alternate destination on the next archival operation.

Use the `NOALTERNATE` attribute to prevent the original archive destination from automatically changing to an alternate archive destination when the original archive destination fails.

[Example A-2](#) shows how to set the initialization parameters so that a single, mandatory, local destination automatically fails over to a different destination if any error occurs.

### Example A-2 Specifying an Alternate Destination

```
LOG_ARCHIVE_DEST_1='LOCATION=/disk1 MANDATORY ALTERNATE=LOG_ARCHIVE_DEST_2'  
LOG_ARCHIVE_DEST_STATE_1=ENABLE  
LOG_ARCHIVE_DEST_2='LOCATION=/disk2 MANDATORY'  
LOG_ARCHIVE_DEST_STATE_2=ALTERNATE
```

If the `LOG_ARCHIVE_DEST_1` destination fails, the archiving process automatically switches to the `LOG_ARCHIVE_DEST_2` destination at the next log file switch on the primary database.

## A.3 Handling Logical Standby Database Failures

An important tool for handling logical standby database failures is the `DBMS_LOGSTDBY.SKIP_ERROR` procedure.



Depending on how important a table is, you might want to do one of the following:

- Ignore failures for a table or specific DDL
- Associate a stored procedure with a filter so at runtime a determination can be made about skipping the statement, executing this statement, or executing a replacement statement

Taking one of these actions prevents SQL Apply from stopping. Later, you can query the `DBA_LOGSTDBY_EVENTS` view to find and correct any problems that exist. See *Oracle Database PL/SQL Packages and Types Reference* for more information about using the `DBMS_LOGSTDBY` package with PL/SQL callout procedures.

## A.4 Problems Switching Over to a Physical Standby Database

These are some of the problems that can cause a switchover to be unsuccessful, and possible solutions.

- [Switchover Fails Because Redo Data Was Not Transmitted](#)
- [Switchover Fails with the ORA-01102 Error](#)
- [Redo Data Is Not Applied After Switchover](#)
- [Roll Back After Unsuccessful Switchover and Start Over](#)

### A.4.1 Switchover Fails Because Redo Data Was Not Transmitted

If the switchover does not complete successfully, you can query the `SEQUENCE#` column in the `V$ARCHIVED_LOG` view to see if the last redo data transmitted from the original primary database was applied on the standby database.

If the last redo data was not transmitted to the standby database, you can manually copy the archived redo log file containing the redo data from the original primary database to the old standby database and register it with the `SQL ALTER DATABASE REGISTER LOGFILE file_specification` statement. If you then start apply services, the archived redo log file is applied automatically. Query the `SWITCHOVER_STATUS` column in the `V$DATABASE` view. A switchover to the primary role is now possible if the `SWITCHOVER_STATUS` column returns `TO PRIMARY` or `SESSIONS ACTIVE`.

```
SQL> SELECT SWITCHOVER_STATUS FROM V$DATABASE;
```

```
SWITCHOVER_STATUS
-----
TO PRIMARY
1 row selected
```

To continue with the switchover, follow the instructions in [Performing a Switchover to a Physical Standby Database](#) for physical standby databases or [Performing a Switchover to a Logical Standby Database](#) for logical standby databases, and try again to switch the target standby database to the primary role.

## A.4.2 Switchover Fails with the ORA-01102 Error

This is an explanation of why you may receive an ORA-01102 error during a switchover, and what action to take.

Suppose the standby database and the primary database reside on the same site. After the `ALTER DATABASE SWITCHOVER TO target_db_name` statement is successfully executed, shut down and restart the physical standby database and the primary database.

### Note:

It is not necessary to shut down and restart the physical standby database if it has not been opened read-only since the instance was started.

However, the startup of the second database fails with ORA-01102 error "cannot mount database in EXCLUSIVE mode."

This could happen during the switchover if you did not set the `DB_UNIQUE_NAME` parameter in the initialization parameter file that is used by the standby database (the original primary database). If the `DB_UNIQUE_NAME` parameter of the standby database is not set, the standby and the primary databases both use the same mount lock and cause the ORA-01102 error during the startup of the second database.

Action: Add `DB_UNIQUE_NAME=unique_database_name` to the initialization parameter file used by the standby database, and shut down and restart the standby and primary databases.

## A.4.3 Redo Data Is Not Applied After Switchover

If the archived redo log files are not applied to the new standby database after the switchover, it could be because some environment or initialization parameters were not properly set after the switchover.

Action:

- Check the `tnsnames.ora` file at the new primary site and the `listener.ora` file at the new standby site. There should be entries for a listener at the standby site and a corresponding service name at the primary site.
- Start the listener at the standby site if it has not been started.
- Check if the `LOG_ARCHIVE_DEST_n` initialization parameter was set to properly transmit redo data from the primary site to the standby site. For example, query the `V$ARCHIVE_DEST` fixed view at the primary site as follows:

```
SQL> SELECT DEST_ID, STATUS, DESTINATION FROM V$ARCHIVE_DEST;
```

If you do not see an entry corresponding to the standby site, you need to set `LOG_ARCHIVE_DEST_n` and `LOG_ARCHIVE_DEST_STATE_n` initialization parameters.

- Verify that the `LOG_ARCHIVE_FORMAT` initialization parameter is set correctly at the standby site.

- At the standby site, set the `DB_FILE_NAME_CONVERT` and `LOG_FILE_NAME_CONVERT` initialization parameters. Set the `STANDBY_FILE_MANAGEMENT` initialization parameter to `AUTO` to enable the standby site to automatically add new data files that are created at the primary site.

## A.4.4 Roll Back After Unsuccessful Switchover and Start Over

For physical standby databases in situations where an error occurred and it is not possible to continue with the switchover, it might still be possible to revert the new physical standby database back to the primary role.

Take the following steps. (This functionality is available starting with Oracle Database 11g Release 2 (11.2.0.2).)

1. Shut down and mount the new standby database (old primary).
2. Start Redo Apply on the new standby database.
3. Verify that the new standby database is ready to be switched back to the primary role. Query the `SWITCHOVER_STATUS` column of the `V$DATABASE` view on the new standby database. For example:

```
SQL> SELECT SWITCHOVER_STATUS FROM V$DATABASE;

SWITCHOVER_STATUS
-----
TO_PRIMARY
1 row selected
```

A value of `TO PRIMARY` or `SESSIONS ACTIVE` indicates that the new standby database is ready to be switched to the primary role. Continue to query this column until the value returned is either `TO PRIMARY` or `SESSIONS ACTIVE`.

4. Issue the following statement to convert the new standby database back to the primary role:

```
SQL> ALTER DATABASE SWITCHOVER TO target_db_name [FORCE];
```

If this statement is successful, then the database runs in the primary database role, and you do not need to perform any more steps.

If this statement is unsuccessful, then continue with Step 5.

5. When the switchover to change the role from primary to physical standby was initiated, a trace file was written in the log directory. This trace file contains the SQL statements required to re-create the original primary control file. Locate the trace file and extract the SQL statements into a temporary file. Execute the temporary file from `SQL*Plus`. This reverts the new standby database back to the primary role.
6. Shut down the original physical standby database.
7. Create a new standby control file. This is necessary to resynchronize the primary database and physical standby database. Copy the physical standby control file to the original physical standby system. [Create a Control File for the Standby Database](#) describes how to create a physical standby control file.
8. Restart the original physical standby instance.

If this procedure is successful and archive gap management is enabled, then the FAL processes start and re-archive any missing archived redo log files to

the physical standby database. Force a log switch on the primary database and examine the alert logs on both the primary database and physical standby database to ensure the archived redo log file sequence numbers are correct.

See [Manual Gap Resolution](#) for information about archive gap management and [Setting Archive Tracing](#) for information about locating the trace files.

9. Try the switchover again.

At this point, the Oracle Data Guard configuration has been rolled back to its initial state, and you can try the switchover operation again (after correcting any problems that might have led to the initial unsuccessful switchover).

## A.5 Problems Switching Over to a Logical Standby Database

A switchover operation involving a logical standby database usually consists of two phases: preparing and committing. The exceptions to this are for rolling upgrades of Oracle software using a logical standby database or if you are using Oracle Data Guard broker.

If you experience failures in the context of doing a rolling upgrade using a logical standby database or during a switchover operation initiated by Oracle Data Guard broker, then go directly to [Failures During the Commit Phase of a Switchover Operation](#).

### Note:

Oracle recommends that Flashback Database be enabled for all databases in an Oracle Data Guard configuration. The steps in this section assume that you have Flashback Database enabled on all databases in your Oracle Data Guard configuration.

### A.5.1 Failures During the Prepare Phase of a Switchover Operation

If a failure occurs during the preparation phase of a switchover operation, then cancel the switchover and retry the switchover operation from the very beginning.

#### A.5.1.1 Failure While Preparing the Primary Database

If you encounter failure while executing the `ALTER DATABASE PREPARE TO SWITCHOVER TO LOGICAL STANDBY` statement, you can cancel the prepare phase of a switchover.

To do so, issue the following SQL statement at the primary database:

```
SQL> ALTER DATABASE PREPARE TO SWITCHOVER TO LOGICAL STANDBY CANCEL;
```

You can now retry the switchover operation from the beginning.

## A.5.1.2 Failure While Preparing the Logical Standby Database

If you encounter failure while executing the `ALTER DATABASE PREPARE TO SWITCHOVER TO PRIMARY` statement, you need to cancel the prepare operation at the primary database and at the target standby database.

Take the following steps:

1. At the primary database, cancel the statement you had issued to prepare for the switchover:

```
SQL> ALTER DATABASE PREPARE TO SWITCHOVER TO LOGICAL STANDBY CANCEL;
```

2. At the logical standby database that was the target of the switchover, cancel the statement you had issued to prepare to switch over:

```
SQL> ALTER DATABASE PREPARE TO SWITCHOVER TO PRIMARY CANCEL;
```

You can now retry the switchover operation from the beginning.

## A.5.2 Failures During the Commit Phase of a Switchover Operation

Although committing to a switchover involves a single SQL statement, internally a number of operations are performed.

The corrective actions that you need to take depend on the state of the commit to switchover operation when the error was encountered.

### A.5.2.1 Failure to Convert the Original Primary Database

If you encounter failures while executing the `ALTER DATABASE COMMIT TO SWITCHOVER TO LOGICAL STANDBY` statement, there are corrective steps you can take.

1. Check the `DATABASE_ROLE` column of the `V$DATABASE` fixed view on the original primary database:

```
SQL> SELECT DATABASE_ROLE FROM V$DATABASE;
```

- If the column contains a value of `LOGICAL STANDBY`, the switchover operation has completed, but has failed during a post-switchover task. In this situation, Oracle recommends that you shut down and reopen the database.
- If the column contains a value of `PRIMARY`, proceed to Step 2.

2. Perform the following query on the original primary:

```
SQL> SELECT COUNT(*) FROM SYSTEM.LOGSTDBY$PARAMETERS -  
> WHERE NAME = 'END_PRIMARY';
```

- If the query returns a 0, the primary is in a state identical to that it was in before the commit to switchover command was issued. You do not need to take any corrective action. You can proceed with the commit to switchover operation or cancel the switchover operation as outlined in [Failure While Preparing the Logical Standby Database](#).
- If the query returns a 1, the primary is in an inconsistent state, and you need to proceed to Step 3.

3. Take corrective action at the original primary database to maintain its ability to be protected by existing or newly instantiated logical standby databases.

You can either fix the underlying cause of the error raised during the commit to switchover operation and reissue the SQL statement (`ALTER DATABASE COMMIT TO SWITCHOVER TO LOGICAL STANDBY`) or you can take the following steps:

- a. From the alert log of the instance where you initiated the commit to switchover command, determine the SCN needed to flash back to the original primary. This information is displayed after the `ALTER DATABASE COMMIT TO SWITCHOVER TO LOGICAL STANDBY` SQL statement:

```
LOGSTDBY: Preparing the COMMIT TO SWITCHOVER TO LOGICAL STANDBY DDL at
scn [flashback_scn].
```

- b. Shut down all instances of the primary database:

```
SQL> SHUTDOWN IMMEDIATE;
```

- c. Mount the primary database in exclusive mode:

```
SQL> STARTUP MOUNT;
```

- d. Flash back the database to the SCN taken from the alert log:

```
SQL> FLASHBACK DATABASE TO BEFORE SCN <flashback_scn>;
```

- e. Open the primary database:

```
SQL> STARTUP;
```

- f. Lower the database guard at the original primary database:

```
SQL> ALTER DATABASE GUARD NONE;
```

At this point the primary is in a state identical to that it was in before the commit switchover command was issued. You do not need to take any corrective action. you can proceed with the commit to switchover operation or cancel the switchover operation as outlined in [Failure While Preparing the Primary Database](#) .

## A.5.2.2 Failure to Convert the Target Logical Standby Database

If you encounter failures while executing the `ALTER DATABASE COMMIT TO SWITCHOVER TO PRIMARY` statement, there are corrective steps you can take.

1. Check the `DATABASE_ROLE` column of the `V$DATABASE` fixed view on the target standby database:

```
SQL> SELECT DATABASE_ROLE FROM V$DATABASE;
```

- If the column contains a value `PRIMARY`, the switchover operation has completed, but has failed during a post-switchover task. In this situation, you must perform the following steps:
  - a. Shut down and reopen the database.
  - b. Issue an `ALTER DATABASE GUARD NONE` command to remove write restrictions to the database.
- If the column contains a value of `LOGICAL STANDBY`, proceed to Step 2.

2. Perform the following query on the target logical standby:

```
SQL> SELECT COUNT(*) FROM SYSTEM.LOGSTDBY$PARAMETERS -
> WHERE NAME = 'BEGIN_PRIMARY';
```

- If the query returns a 0, the logical standby is in a state identical to that it was in before the commit to switchover command was issued. You do not need to take any corrective action. You can proceed with the commit to switchover operations or cancel the switchover operation as outlined in [Failure While Preparing the Logical Standby Database](#).
  - If the query returns a 1, then the logical standby is in an inconsistent state. Proceed to Step 3.
3. Take corrective action at the logical standby to maintain its ability to either become the new primary or become a bystander to a different new primary.

You can either fix the underlying cause of the error raised during the commit to switchover operation and reissue the SQL statement (`ALTER DATABASE COMMIT TO SWITCHOVER TO PRIMARY`) or you can take the following steps to flash back the logical standby database to a point of consistency just prior to the commit to switchover attempt:

- a. From the alert log of the instance where you initiated the commit to switchover command, determine the SCN needed to flash back to the logical standby. This information is displayed after the `ALTER DATABASE COMMIT TO SWITCHOVER TO PRIMARY` SQL statement:

```
LOGSTDBY: Preparing the COMMIT TO SWITCHOVER TO PRIMARY DDL at scn
[flashback_scn].
```

- b. Shut down all instances of the target standby database:

```
SQL> SHUTDOWN IMMEDIATE;
```

- c. Mount the target logical standby database:

```
SQL> STARTUP MOUNT;
```

- d. Flash back the target logical standby to the desired SCN:

```
SQL> FLASHBACK DATABASE TO BEFORE SCN <flashback_scn>;
```

- e. Open the database (in case of an Oracle RAC, open all instances);

```
SQL> STARTUP OPEN;
```

At this point the target standby is in a state identical to that it was in before the commit to switchover command was issued. You do not need to take any further corrective action. You can proceed with the commit to switchover operation.

## A.6 What to Do If SQL Apply Stops

When an unsupported statement or package is encountered, SQL Apply stops.

Apply services cannot apply unsupported DML statements, DDL statements, and Oracle supplied packages to a logical standby database running SQL Apply.

If SQL Apply has stopped because of an unsupported statement or package, you can take the actions described in [Table A-1](#) to correct the situation and start SQL Apply on the logical standby database again.

**Table A-1 Fixing Typical SQL Apply Errors**

| If...                                                                                                                                                                                                                                                  | Then...                                                                                                                                                                                                                                                                                                                                                                                   |
|--------------------------------------------------------------------------------------------------------------------------------------------------------------------------------------------------------------------------------------------------------|-------------------------------------------------------------------------------------------------------------------------------------------------------------------------------------------------------------------------------------------------------------------------------------------------------------------------------------------------------------------------------------------|
| You suspect an unsupported statement or Oracle supplied package was encountered                                                                                                                                                                        | Find the last statement in the <code>DBA_LOGSTDBY_EVENTS</code> view. It shows the statement and error that caused SQL Apply to fail. If an incorrect SQL statement caused SQL Apply to fail, transaction information, as well as the statement and error information, can be viewed. The transaction information can be used with LogMiner tools to understand the cause of the problem. |
| An error requiring database management occurred, such as running out of space in a particular tablespace                                                                                                                                               | Fix the problem and resume SQL Apply using the <code>ALTER DATABASE START LOGICAL STANDBY APPLY</code> statement.                                                                                                                                                                                                                                                                         |
| An error occurred because a SQL statement was entered incorrectly, such as an incorrect standby database filename being entered in a tablespace statement                                                                                              | Enter the correct SQL statement and use the <code>DBMS_LOGSTDBY.SKIP_TRANSACTION</code> procedure to ensure the incorrect statement is ignored the next time SQL Apply is run. Then, restart SQL Apply using the <code>ALTER DATABASE START LOGICAL STANDBY APPLY</code> statement.                                                                                                       |
| An error occurred because skip parameters were incorrectly set up, such as specifying that all DML for a given table be skipped but <code>CREATE</code> , <code>ALTER</code> , and <code>DROP TABLE</code> statements were not specified to be skipped | Issue the <code>DBMS_LOGSTDBY.SKIP('TABLE', 'schema_name', 'table_name', null)</code> procedure, then restart SQL Apply.                                                                                                                                                                                                                                                                  |

See [Views Relevant to Oracle Data Guard](#) for information about querying the `DBA_LOGSTDBY_EVENTS` view to determine the cause of failures.

## A.7 Network Tuning for Redo Data Transmission

For optimal performance, set the Oracle Net SDU parameter to its maximum value of 65535 bytes in each Oracle Net connect descriptor used by redo transport services.

The following example shows a database initialization parameter file segment that defines a remote destination `netserv`:

```
LOG_ARCHIVE_DEST_3='SERVICE=netserv'
```

The following example shows the definition of that service name in the `tnsnames.ora` file:

```
netserv=(DESCRIPTION=(SDU=32768)(ADDRESS=(PROTOCOL=tcp)(HOST=host)(PORT=1521))
(CONNECT_DATA=(SERVICE_NAME=srvc)))
```

The following example shows the definition in the `listener.ora` file:

```
LISTENER=(DESCRIPTION=(ADDRESS_LIST=(ADDRESS=(PROTOCOL=tcp)
(HOST=host)(PORT=1521))))

SID_LIST_LISTENER=(SID_LIST=(SID_DESC=(SDU=32768)(SID_NAME=sid)
(GLOBALDBNAME=srvc)(ORACLE_HOME=/oracle)))
```

If you archive to a remote site using a high-latency or high-bandwidth network link, you can improve performance by using the `SQLNET.SEND_BUF_SIZE` and `SQLNET.RECV_BUF_SIZE` Oracle Net profile parameters to increase the size of the network send and receive I/O buffers.



See *Oracle Database Net Services Administrator's Guide* for information about other ways to change the Oracle NET SDU parameter.

## A.8 Slow Disk Performance on Standby Databases

If asynchronous I/O on the file system itself is showing performance problems, try mounting the file system using the Direct I/O option or setting the `FILESYSTEMIO_OPTIONS=SETALL` initialization parameter.

The maximum I/O size setting is 1 MB.

## A.9 Log Files Must Match to Avoid Primary Database Shutdown

If you have configured a standby redo log on one or more standby databases in the configuration, ensure the size of the standby redo log files on each standby database exactly matches the size of the online redo log files on the primary database.

At log switch time, if there are no available standby redo log files that match the size of the new current online redo log file on the primary database:

- The primary database shuts down if it is operating in maximum protection mode,  
**or**
- The RFS process on the standby database creates an archived redo log file on the standby database and writes the following message in the alert log:

```
No standby log files of size <#> blocks available.
```

For example, if the primary database uses two online redo log groups whose log files are 100K, then the standby database should have 3 standby redo log groups with log file sizes of 100K.

Also, whenever you add a redo log group to the primary database, you must add a corresponding standby redo log group to the standby database. This reduces the probability of adverse effects on the primary database because a standby redo log file of the required size is not available at log switch time.

## A.10 Troubleshooting a Logical Standby Database

These troubleshooting tips can help you recover from errors.

- [Recovering from Errors](#)
- [Troubleshooting SQL\\*Loader Sessions](#)
- [Troubleshooting Long-Running Transactions](#)
- [Troubleshooting ORA-1403 Errors with Flashback Transactions](#)

### A.10.1 Recovering from Errors

Logical standby databases maintain user tables, sequences, and jobs. To maintain other objects, you must reissue the DDL statements seen in the redo data stream.

If SQL Apply fails, an error is recorded in the `DBA_LOGSTDBY_EVENTS` table. The following sections demonstrate how to recover from two such errors.

### A.10.1.1 DDL Transactions Containing File Specifications

DDL statements are executed the same way on the primary database and the logical standby database.

If the underlying file structure is the same on both databases, then the DDL executes on the standby database as expected.

If an error was caused by a DDL transaction containing a file specification that did not match in the logical standby database environment, perform the following steps to fix the problem:

1. Use the `ALTER SESSION DISABLE GUARD` statement to bypass the database guard so you can make modifications to the logical standby database:

```
SQL> ALTER SESSION DISABLE GUARD;
```

2. Execute the DDL statement, using the correct file specification, and then reenables the database guard. For example:

```
SQL> ALTER TABLESPACE t_table ADD DATAFILE '/dbs/t_db.f' SIZE 100M REUSE;
SQL> ALTER SESSION ENABLE GUARD;
```

3. Start SQL Apply on the logical standby database and skip the failed transaction.

```
SQL> ALTER DATABASE START LOGICAL STANDBY APPLY IMMEDIATE -
> SKIP FAILED TRANSACTION;
```

In some situations, the problem that caused the transaction to fail can be corrected and SQL Apply restarted without skipping the transaction. An example of this might be when available space is exhausted. (Do not let the primary and logical standby databases diverge when skipping DDL transactions. If possible, manually execute a compensating transaction in place of the skipped transaction.)

The following example shows SQL Apply stopping, the error being corrected, and then restarting SQL Apply:

```
SQL> SET LONG 1000
SQL> ALTER SESSION SET NLS_DATE_FORMAT = 'DD-MON-YY HH24:MI:SS';
```

```
Session altered.
```

```
SQL> SELECT EVENT_TIME, COMMIT_SCN, EVENT, STATUS FROM DBA_LOGSTDBY_EVENTS;
```

```
EVENT_TIME          COMMIT_SCN
-----
EVENT
-----
STATUS
-----
22-OCT-03 15:47:58

ORA-16111: log mining and apply setting up

22-OCT-03 15:48:04          209627
insert into "SCOTT"."EMP"
values
  "EMPNO" = 7900,
  "ENAME" = 'ADAMS',
```

```
"JOB" = 'CLERK',
"MGR" IS NULL,
"HIREDATE" = TO_DATE('22-OCT-03', 'DD-MON-RR'),
"SAL" = 950,
"COMM" IS NULL,
"DEPTNO" IS NULL
ORA-01653: unable to extend table SCOTT.EMP by %200 bytes in tablespace T_TABLE
```

In the example, the ORA-01653 message indicates that the tablespace was full and unable to extend itself. To correct the problem, add a new data file to the tablespace. For example:

```
SQL> ALTER TABLESPACE t_table ADD DATAFILE '/dbs/t_db.f' SIZE 60M;
Tablespace altered.
```

Then, restart SQL Apply:

```
SQL> ALTER DATABASE START LOGICAL STANDBY APPLY IMMEDIATE;
Database altered.
```

When SQL Apply restarts, the transaction that failed is reexecuted and applied to the logical standby database.

### A.10.1.2 Recovering from DML Failures

Do not use the `SKIP_TRANSACTION` procedure to filter DML failures because it will skip not only the DML seen in the events table, but all the DML associated with the transaction as well.

DML failures usually indicate a problem with a specific table. For example, assume the failure is an out-of-storage error that you cannot resolve immediately. The following steps demonstrate one way to respond to this problem.

1. Bypass the table, but not the transaction, by adding the table to the skip list:

```
SQL> EXECUTE DBMS_LOGSTDBY.SKIP('DML', 'SCOTT', 'EMP');
SQL> ALTER DATABASE START LOGICAL STANDBY APPLY IMMEDIATE;
```

From this point on, DML activity for the `SCOTT.EMP` table is not applied. After you correct the storage problem, you can fix the table, provided you set up a database link to the primary database that has administrator privileges to run procedures in the `DBMS_LOGSTDBY` package.

2. Using the database link to the primary database, drop the local `SCOTT.EMP` table and then re-create it, and pull the data over to the standby database.

```
SQL> ALTER DATABASE STOP LOGICAL STANDBY APPLY;
SQL> EXECUTE DBMS_LOGSTDBY.INSTANTIATE_TABLE('SCOTT', 'EMP', 'PRIMARYDB');
SQL> ALTER DATABASE START LOGICAL STANDBY APPLY IMMEDIATE;
```

3. To ensure a consistent view across the newly instantiated table and the rest of the database, wait for SQL Apply to catch up with the primary database before querying this table. Refer to [Adding or Re-Creating Tables On a Logical Standby Database](#) for a detailed example.

### A.10.2 Troubleshooting SQL\*Loader Sessions

Oracle SQL\*Loader provides a method of loading data from different sources into the Oracle Database.

This topic analyzes some of the features of the SQL\*Loader utility as it pertains to SQL Apply.

Regardless of the method of data load chosen, the SQL\*Loader control files contain an instruction on what to do to the current contents of the Oracle table into which the new data is to be loaded, via the keywords of `APPEND` and `REPLACE`. The following examples show how to use these keywords on a table named `LOAD_STOK`:

- When using the `APPEND` keyword, the new data to be loaded is appended to the contents of the `LOAD_STOK` table:

```
LOAD DATA
INTO TABLE LOAD_STOK APPEND
```

- When using the `REPLACE` keyword, the contents of the `LOAD_STOK` table are deleted prior to loading new data. Oracle SQL\*Loader uses the `DELETE` statement to purge the contents of the table, in a single transaction:

```
LOAD DATA
INTO TABLE LOAD_STOK REPLACE
```

Rather than using the `REPLACE` keyword in the SQL\*Loader script, Oracle recommends that prior to loading the data, you issue the SQL\*Plus `TRUNCATE TABLE` command against the table on the primary database. This has the same effect of purging both the primary and standby databases copy of the table in a manner that is both fast and efficient because the `TRUNCATE TABLE` command is recorded in the online redo log files and is issued by SQL Apply on the logical standby database.

The SQL\*Loader script may continue to contain the `REPLACE` keyword, but it now attempts to `DELETE` zero rows from the object on the primary database. Because no rows were deleted from the primary database, there is no redo recorded in the redo log files. Therefore, no `DELETE` statement is issued against the logical standby database.

Issuing the `REPLACE` keyword without the SQL statement `TRUNCATE TABLE` provides the following potential problems for SQL Apply when the transaction needs to be applied to the logical standby database.

- If the table currently contains a significant number of rows, then these rows need to be deleted from the standby database. Because SQL Apply is not able to determine the original syntax of the statement, SQL Apply must issue a `DELETE` statement for each row purged from the primary database.

For example, if the table on the primary database originally had 10,000 rows, then Oracle SQL\*Loader issues a single `DELETE` statement to purge the 10,000 rows. On the standby database, SQL Apply does not know that all rows are to be purged, and instead must issue 10,000 individual `DELETE` statements, with each statement purging a single row.

- If the table on the standby database does not contain an index that can be used by SQL Apply, then the `DELETE` statement issues a Full Table Scan to purge the information.

Continuing with the previous example, because SQL Apply has issued 10,000 individual `DELETE` statements, this could result in 10,000 Full Table Scans being issued against the standby database.

## A.10.3 Troubleshooting Long-Running Transactions

One of the primary causes for long-running transactions in a SQL Apply environment is full table scans.

Additionally, long-running transactions could be the result of SQL statements being replicated to the standby database, such as when creating or rebuilding an index.

### Identifying Long-Running Transactions

If SQL Apply is executing a single SQL statement for a long period of time, then a warning message similar to the following is reported in the alert log of the SQL Apply instance:

```
Mon Feb 17 14:40:15 2003
WARNING: the following transaction makes no progress
WARNING: in the last 30 seconds for the given message!
WARNING: xid =
0x0016.007.000017b6 cscn = 1550349, message# = 28, slavid = 1
knacrb: no offending session found (not ITL pressure)
```

Note the following about the warning message:

- This warning is similar to the warning message returned for interested transaction list (ITL) pressure, with the exception being the last line that begins with `knacrb`. The final line indicates:
  - A Full Table Scan may be occurring
  - This issue has nothing to do with interested transaction list (ITL) pressure
- This warning message is reported only if a single statement takes more than 30 seconds to execute.

It may not be possible to determine the SQL statement being executed by the long-running statement, but the following SQL statement may help in identifying the database objects on which SQL Apply is operating:

```
SQL> SELECT SAS.SERVER_ID -
> , SS.OWNER -
> , SS.OBJECT_NAME -
> , SS.STATISTIC_NAME -
> , SS.VALUE -
> FROM V$SEGMENT_STATISTICS SS -
> , V$LOCK L -
> , V$STREAMS_APPLY_SERVER SAS -
> WHERE SAS.SERVER_ID = &SLAVE_ID -
> AND L.SID = SAS.SID -
> AND L.TYPE = 'TM' -
> AND SS.OBJ# = L.ID1;
```

Additionally, you can issue the following SQL statement to identify the SQL statement that has resulted in a large number of disk reads being issued per execution:

```
SQL> SELECT SUBSTR(SQL_TEXT,1,40) -
> , DISK_READS -
> , EXECUTIONS -
> , DISK_READS/EXECUTIONS -
> , HASH_VALUE -
> , ADDRESS -
```

```

> FROM V$SQLAREA -
> WHERE DISK_READS/GREATEST(EXECUTIONS,1) > 1 -
> AND ROWNUM < 10 -
> ORDER BY DISK_READS/GREATEST(EXECUTIONS,1) DESC;

```

Oracle recommends that all tables have primary key constraints defined, which automatically means that the column is defined as NOT NULL. For any table where a primary-key constraint cannot be defined, define an index on an appropriate column that is defined as NOT NULL. If a suitable column does not exist on the table, then the table should be reviewed and, if possible, skipped by SQL Apply. The following steps describe how to skip all DML statements issued against the FTS table on the SCOTT schema:

### 1. Stop SQL Apply:

```

SQL> ALTER DATABASE STOP LOGICAL STANDBY APPLY;
Database altered

```

### 2. Configure the skip procedure for the SCOTT.FTS table for all DML transactions:

```

SQL> EXECUTE DBMS_LOGSTDBY.SKIP(stmt => 'DML' , -
> schema_name => 'SCOTT' , -
> object_name => 'FTS');
PL/SQL procedure successfully completed

```

### 3. Start SQL Apply:

```

SQL> ALTER DATABASE START LOGICAL STANDBY APPLY IMMEDIATE;
Database altered

```

## Troubleshooting ITL Pressure

Interested transaction list (ITL) pressure is reported in the alert log of the SQL Apply instance. The following shows an example of the warning messages.

```

Tue Apr 22 15:50:42 2003
WARNING: the following transaction makes no progress
WARNING: in the last 30 seconds for the given message!
WARNING: xid =
0x0006.005.000029fa cscn = 2152982, message# = 2, slavid = 17

```

## Real-Time Analysis

The messages shown in the above output indicate that the SQL Apply process (slavid) #17 has not made any progress in the last 30 seconds. To determine the SQL statement being issued by the Apply process, issue the following query:

```

SQL> SELECT SA.SQL_TEXT -
> FROM V$SQLAREA SA -
> , V$SESSION S -
> , V$STREAMS_APPLY_SERVER SAS -
> WHERE SAS.SERVER_ID = &SLAVEID -
> AND S.SID = SAS.SID -
> AND SA.ADDRESS = S.SQL_ADDRESS

```

SQL\_TEXT  
-----  
insert into "APP"."LOAD\_TAB\_1" p("PK","TEXT")values(:1,:2)

An alternative method to identifying ITL pressure is to query the V\$LOCK view, as shown in the following example. Any session that has a request value of 4 on a TX lock, is waiting for an ITL to become available.

```
SQL> SELECT SID,TYPE, ID1, ID2, LMODE, REQUEST -
> FROM V$LOCK -
> WHERE TYPE = 'TX'
```

| SID | TY | ID1    | ID2 | LMODE | REQUEST |
|-----|----|--------|-----|-------|---------|
| 8   | TX | 327688 |     | 48    | 6       |
| 10  | TX | 327688 |     | 48    | 0       |

In this example, SID 10 is waiting for the TX lock held by SID 8.

### Post-Incident Review

Pressure for a segment's ITL is unlikely to last for an extended period of time. In addition, ITL pressure that lasts for less than 30 seconds is not reported in the standby databases alert log. Therefore, to determine which objects have been subjected to ITL pressure, issue the following statement:

```
SQL> SELECT OWNER, OBJECT_NAME, OBJECT_TYPE -
> FROM V$SEGMENT_STATISTICS -
> WHERE STATISTIC_NAME = 'ITL waits' -
> AND VALUE > 0 -
> ORDER BY VALUE;
```

This statement reports all database segments that have had ITL pressure at some time since the instance was last started.



#### Note:

This SQL statement is not limited to a logical standby databases in the Oracle Data Guard environment. It is applicable to any Oracle database.

### Resolving ITL Pressure

To increase the `INITRANS` integer for a particular database object, it is necessary to first stop SQL Apply.



#### See Also:

*Oracle Database SQL Language Reference* for more information about specifying the `INITRANS` integer, which is the initial number of concurrent transaction entries allocated within each data block allocated to the database object

The following example shows the necessary steps to increase the `INITRANS` for table `load_tab_1` in the schema `app`.

1. Stop SQL Apply:

```
SQL> ALTER DATABASE STOP LOGICAL STANDBY APPLY;
Database altered.
```

2. Temporarily bypass the database guard:

```
SQL> ALTER SESSION DISABLE GUARD;
Session altered.
```

3. Increase the `INITRANS` on the standby database. For example:

```
SQL> ALTER TABLE APP.LOAD_TAB_1 INITRANS 30;
Table altered
```

4. Reenable the database guard:

```
SQL> ALTER SESSION ENABLE GUARD;
Session altered
```

5. Start SQL Apply:

```
SQL> ALTER DATABASE START LOGICAL STANDBY APPLY IMMEDIATE;
Database altered.
```

Also, consider modifying the database object on the primary database, so that in the event of a switchover, the error does not occur on the new standby database.

## A.10.4 Troubleshooting ORA-1403 Errors with Flashback Transactions

If SQL Apply returns the `ORA-1403: No Data Found` error, then it may be possible to use Flashback Transaction to reconstruct the missing data.

This strategy relies upon the `UNDO_RETENTION` initialization parameter specified on the standby database instance.

Under normal circumstances, the `ORA-1403` error is not seen in a logical standby database environment. The error occurs when data in a table that is being managed by SQL Apply is modified directly on the standby database and then the same data is modified on the primary database. When the modified data is updated on the primary database and is subsequently received on the logical standby database, SQL Apply verifies the original version of the data is present on the standby database before updating the record. When this verification fails, the `ORA-1403: No Data Found` error is returned.

### The Initial Error

When SQL Apply verification fails, the error message is reported in the alert log of the logical standby database and a record is inserted in the `DBA_LOGSTDBY_EVENTS` view. The information in the alert log is truncated, while the error is reported in its entirety in the database view. For example:

```
LOGSTDBY stmt: UPDATE "SCOTT"."MASTER"
SET
  "NAME" = 'john'
WHERE
  "PK" = 1 and
  "NAME" = 'andrew' and
  ROWID = 'AAAAAAAAEAAAAAPAAA'
LOGSTDBY status: ORA-01403: no data found
LOGSTDBY PID 1006, oracle@staco03 (P004)
LOGSTDBY XID 0x0006.00e.00000417, Thread 1, RBA 0x02dd.00002221.10
```

### The Investigation

The first step is to analyze the historical data of the table that caused the error. This can be achieved using the `VERSIONS` clause of the `SELECT` statement. For example, you can issue the following query on the primary database:



```
SELECT VERSIONS_XID
       , VERSIONS_STARTSCN
       , VERSIONS_ENDSCN
       , VERSIONS_OPERATION
       , PK
       , NAME
FROM SCOTT.MASTER
     VERSIONS BETWEEN SCN MINVALUE AND MAXVALUE
WHERE PK = 1
ORDER BY NVL(VERSIONS_STARTSCN,0);
```

| VERSIONS_XID     | VERSIONS_STARTSCN | VERSIONS_ENDSCN | V | PK | NAME   |
|------------------|-------------------|-----------------|---|----|--------|
| 03001900EE070000 | 3492279           | 3492290         | I | 1  | andrew |
| 02000D00E4070000 | 3492290           |                 | D | 1  | andrew |

Depending upon the amount of undo retention that the database is configured to retain (`UNDO_RETENTION`) and the activity on the table, the information returned might be extensive and you may need to change the versions between syntax to restrict the amount of information returned. From the information returned, you can see that the record was first inserted at SCN 3492279 and then was deleted at SCN 3492290 as part of transaction ID 02000D00E4070000. Using the transaction ID, query the database to find the scope of the transaction. This is achieved by querying the `FLASHBACK_TRANSACTION_QUERY` view.

```
SELECT OPERATION
       , UNDO_SQL
FROM FLASHBACK_TRANSACTION_QUERY
WHERE XID = HEXTORAW('02000D00E4070000');

OPERATION  UNDO_SQL
-----
DELETE     insert into "SCOTT"."MASTER"("PK","NAME") values
           ('1','andrew');
```

There is always one row returned representing the start of the transaction. In this transaction, only one row was deleted in the master table. The `UNDO_SQL` column, when executed, restores the original data into the table.

```
SQL> INSERT INTO "SCOTT"."MASTER"("PK","NAME") VALUES ('1','ANDREW');SQL> COMMIT;
```

When you restart SQL Apply, the transaction is applied to the standby database:

```
SQL> ALTER DATABASE START LOGICAL STANDBY APPLY IMMEDIATE;
```

# B

## Patching, Upgrading, and Downgrading Databases in an Oracle Data Guard Configuration

These topics address how to upgrade and downgrade an Oracle database when a physical or logical standby database is present in the Oracle Data Guard configuration.

- [Before You Upgrade the Oracle Database Software](#)
- [Patching Oracle Database with Standby First Patching](#)
- [Upgrading Oracle Database with a Physical Standby Database in Place](#)
- [Upgrading Oracle Database with a Logical Standby Database in Place](#)
- [Modifying the COMPATIBLE Initialization Parameter After Upgrading](#)
- [Downgrading Oracle Database with No Logical Standby in Place](#)
- [Downgrading Oracle Database with a Logical Standby in Place](#)

### B.1 Before You Patch or Upgrade the Oracle Database Software

There are several points to consider before beginning to patch or upgrade your Oracle Database software.

- If you are using the Oracle Data Guard broker to manage your configuration, follow the instructions in the *Oracle Data Guard Broker* manual for information about removing or disabling the broker configuration.
- The procedures described in these topics are to be used in conjunction with the ones contained in the *Oracle Database Upgrade Guide*.
- Check for nologging operations. If nologging operations have been performed then you must update the standby database. See [Recovering After the NOLOGGING Clause Is Specified](#) for details.
- Make note of any tablespaces or data files that need recovery due to `OFFLINE IMMEDIATE`. Tablespaces or data files should be recovered and either online or offline prior to upgrading.
- In an Oracle Data Guard configuration, all physical and snapshot standby databases must use a copy of the password file from the primary database. As of Oracle Database 12c Release 2 (12.2.0.1), password file changes done on the primary database are automatically propagated to standby databases. (Password file changes include when an administrative privilege (`SYSDBG`, `SYSOPER`, `SYSDBA`, and so on) is granted or revoked, and when the password of any user with administrative privileges is changed.)

Far sync instances are an exception to the automatic updating feature. Updated password files must still be manually copied to far sync instances because far

sync instances receive redo, but do not apply it. When a password file is manually updated at a far sync instance, the redo containing the same password changes from the primary database is automatically propagated to any standby databases that are set up to receive redo from that far sync instance. The password file is updated on the standby when the redo is applied.

 **Note:**

If there are cascaded standbys in your configuration then those cascaded standbys must follow the same rules as any other standby but should be shut down last and restarted in the new home first.

## B.2 Patching Oracle Database with Standby First Patching

Oracle Data Guard Standby-First Patch Apply provides support for different database home software between a primary database and its physical standby database(s).

This support is provided for the purpose of applying and validating Oracle patches and patch bundles in rolling fashion with minimal risk to the primary database. For example, with Data Guard Standby-First Patch Apply you apply a database home patch first to a physical standby database. The standby is used to run read-only workload, or read-write workload if it is a snapshot standby, for testing and evaluation of the patch. After passing evaluation, the patch is then installed on the primary system with greater assurance of the effectiveness and stability of the database home patch.

Oracle Data Guard Standby-First Patch Apply is supported only for certified interim patches and patch bundles (for example, Patch Set Update, or Database Patch for Exadata) for Oracle Database 11.2.0.1 and later, on both Oracle Engineered Systems (e.g. Exadata, SuperCluster) and non-Engineered Systems. A patch and patch bundle that is Data Guard Standby-First certified states the following in the patch README:

```
Data Guard Standby-First Installable
```

The following types of patches are candidates to be Data Guard Standby-First certified:

- Database home interim patches
- Exadata bundle patches (e.g. Monthly and quarterly database patches for Exadata)
- Database patch set updates

Patches and patch bundles that update modules that may potentially disrupt the interoperability between primary and physical standby systems running different database home software are not certified “Data Guard Standby-First Installable” and do not state so in the patch README.

Oracle patch sets and major release upgrades do not qualify for Data Guard Standby-First Patch Apply. For example, upgrades from 11.2.0.2 to 11.2.0.3 or 11.2 to 12.1 do not qualify. Use the Data Guard transient logical standby rolling upgrade process for database patch sets and major releases.

Additionally, as of Oracle Database 11g Release 2 (11.2.0.1), a physical standby database can be used to install eligible one-off patches, patch set updates (PSUs), and critical patch updates (CPUs), in rolling fashion. For more information about this functionality, see the My Oracle Support note 1265700.1 at <http://support.oracle.com>.

## B.3 Upgrading Oracle Database with a Physical Standby Database in Place

These steps show how to upgrade to Oracle Database 12c Release 2 (12.2) when a physical standby database is present in the configuration.

1.

 **Note:**

If the database being upgraded is a member of an Oracle Data Guard broker configuration, then before proceeding you must disable fast-start failover and shut down the broker. For information about how to do this, see *Oracle Data Guard Broker*.

Review and perform the steps listed in the "Preparing to Upgrade" chapter of the *Oracle Database Upgrade Guide*.

2. Install the new release of the Oracle software into a new Oracle home on the physical standby database and primary database systems, as described in the *Oracle Database Upgrade Guide*.
3. Shut down the primary database.
4. Shut down the physical standby database(s).
5. Stop all listeners, agents, and other processes running in the Oracle homes that are to be upgraded. Perform this step on all nodes in an Oracle Real Application Clusters (Oracle RAC) environment.
6. If Oracle Automatic Storage Management (Oracle ASM) is in use, shut down all databases that use Oracle ASM, and then shut down all Oracle ASM instance(s).
7. In the new Oracle home, restart all listeners, agents, and other processes that were stopped in step 5.
8. Mount the physical standby database(s) on the new Oracle home (upgraded version). See [Start the Physical Standby Database](#) for information on how to start a physical standby database.

 **Note:**

Do not open the standby database(s) until the primary database upgrade is completed.

9. Start Redo Apply on the physical standby database(s). See [Start the Physical Standby Database](#) for information on how to start Redo Apply.

10. Upgrade the primary database as described in the *Oracle Database Upgrade Guide*. The physical standby database(s) is upgraded when the redo generated by the primary database as it is upgraded is applied.
11. Open the upgraded primary database.
12. If Oracle Active Data Guard was being used prior to the upgrade, then refer to [Real-time query](#) for information about how to reenable it after upgrading.
13. Optionally, modify the `COMPATIBLE` initialization parameter, following the procedure described in [Modifying the COMPATIBLE Initialization Parameter After Upgrading](#).

 **Note:**

On Windows platforms, it is necessary to use the ORADIM utility to delete the database service (for the old database version) and to create a new database service for the new database version. The `OracleService<SID>` must be replaced on both the primary and standby servers.

## B.4 Upgrading Oracle Database with a Logical Standby Database in Place

These steps describe the traditional method for upgrading your Oracle Database software with a logical standby database in place.

 **Note:**

[Using SQL Apply to Upgrade the Oracle Database](#) presents an alternative method to perform an upgrade with a logical standby database in place in a rolling fashion to minimize downtime. Use the steps from only one method to perform the complete upgrade. Do not attempt to use both methods or to combine the steps from the two methods as you perform the upgrade process.

Perform the following steps to upgrade to Oracle Database 12c Release 2 (12.2) when a logical standby database is present in the configuration. These steps assume that the primary database is running in `MAXIMUM PERFORMANCE` data protection mode.

Review and perform the steps listed in the "Preparing to Upgrade" chapter of the *Oracle Database Upgrade Guide*

1. Set the data protection mode to `MAXIMUM PERFORMANCE` at the primary database, if needed:

```
SQL> ALTER DATABASE SET STANDBY DATABASE TO MAXIMIZE PERFORMANCE;
```

2. On the primary database, stop all user activity and defer the remote archival destination associated with the logical standby database (for this procedure, it is assumed that `LOG_ARCHIVE_DEST_2` is associated with the logical standby database):

```
SQL> ALTER SYSTEM SET LOG_ARCHIVE_DEST_STATE_2=DEFER SCOPE=BOTH;
SQL> ALTER SYSTEM ARCHIVE LOG CURRENT;
```

3. Stop SQL Apply on the logical standby database:

```
SQL> ALTER DATABASE STOP LOGICAL STANDBY APPLY;
```

4. On the primary database install the newer release of the Oracle software. .
5. On the logical standby database, install the newer release of the Oracle software.

#### Note:

Steps 4 and 5 can be performed concurrently (in other words, the primary and the standby databases can be upgraded concurrently) to reduce downtime during the upgrade procedure.

6. On the upgraded logical standby database, restart SQL Apply. If you are using Oracle RAC, start up the other standby database instances:

```
SQL> ALTER DATABASE START LOGICAL STANDBY APPLY IMMEDIATE;
```

7. Open the upgraded primary database and allow users to connect. If you are using Oracle RAC, start up the other primary database instances.

Also, enable archiving to the upgraded logical standby database, as follows:

```
SQL> ALTER SYSTEM SET LOG_ARCHIVE_DEST_STATE_2=ENABLE;
```

8. Optionally, reset to the original data protection mode if you changed it in Step 1.
9. Optionally, modify the COMPATIBLE initialization parameter.

#### Related Topics

- *Oracle Database Upgrade Guide*

## B.5 Modifying the COMPATIBLE Initialization Parameter After Upgrading

When you upgrade to a new release of Oracle Database, certain new features might make your database incompatible with your previous release.

Oracle Database enables you to control the compatibility of your database with the COMPATIBLE initialization parameter.

After the upgrade is complete, you can increase the setting of the COMPATIBLE initialization parameter to the maximum level for the new Oracle Database release. When you are certain that you no longer need the ability to downgrade your database back to its original version, set the COMPATIBLE initialization parameter based on the compatibility level you want for your new database.

In an Oracle Data Guard configuration, if you decide to increase the setting of the COMPATIBLE initialization parameter after upgrading, then it is important that you perform the following steps in the order shown (be sure the standby database has a COMPATIBLE setting equal to, or higher than, the primary):

1. Increase the value of the `COMPATIBLE` initialization parameter on all standby databases in the configuration first, as follows:
  - a. Ensure that apply is current on the standby database(s).
  - b. On one instance of each standby database, execute the following SQL statement:

```
ALTER SYSTEM SET COMPATIBLE=<value> SCOPE=SPFILE;
```
  - c. If Redo Apply or SQL Apply is running, then stop them.
  - d. Restart all instances of the standby database(s).
  - e. If you previously stopped Redo Apply or SQL Apply, then restart them.
2. Increase the value of the `COMPATIBLE` initialization parameter on the primary database, as follows:
  - a. On one instance of the primary database, execute the following SQL statement:

```
ALTER SYSTEM SET COMPATIBLE=<value> SCOPE=SPFILE;
```
  - b. Restart all instances of the primary database.

**See Also:**

- *Oracle Database Upgrade Guide* for more information about compatibility settings

## B.6 Downgrading Oracle Database with No Logical Standby in Place

Perform these steps to downgrade Oracle Database in an Oracle Data Guard configuration that does *not* contain a logical standby database.

1. Ensure that all physical standby databases are mounted, but not open. Do not open the standby database(s) until all redo generated by the downgrade of the primary database has been applied.
2. Start Redo Apply, in real-time apply mode, on the physical standby database(s).
3. Downgrade the primary database using the procedure described in *Oracle Database Upgrade Guide*, keeping the following in mind:
  - At each step of the downgrade procedure where a script is executed, execute the script only at the primary database. Do not perform the next downgrade step until all redo generated by the execution of the script at the primary database has been applied to each physical standby database.
  - At each step of the downgrade procedure where an action other than running a script is performed, perform the step at the primary database first and then at each physical standby database. Do not perform the next downgrade step at the primary database until the action has been performed at each physical standby database.

4. If it becomes necessary to perform a failover during a downgrade, perform the failover and then continue with the downgrade procedure at the new primary database.

## B.7 Downgrading Oracle Database with a Logical Standby in Place

Perform these steps to downgrade Oracle Database in an Oracle Data Guard configuration that contains a logical standby database or a mixture of logical and physical standby databases.

1. Issue the following command at the primary database (database P, for the sake of this discussion) before you downgrade it:

```
SQL> ALTER DATABASE COMMIT TO SWITCHOVER TO LOGICAL STANDBY;
```

Database P is no longer in the primary database role.

2. Wait for *all* standby databases in the configuration to finish applying all available redo. To determine whether each standby database has finished applying all available redo, run the following query at each standby database:

```
SQL> SELECT SWITCHOVER_STATUS FROM V$DATABASE;
```

```
SWITCHOVER_STATUS
-----
TO PRIMARY
```

Do not continue on to step 3 until the query returns a value of `TO PRIMARY` for all standby databases in the configuration.

3. Downgrade the logical standby databases using the procedures described in *Oracle Database Upgrade Guide*, keeping the following in mind:
  - At each step of the downgrade procedure where a script is executed, execute the script only at the logical standby databases. Do not perform the next downgrade step until all redo generated by executing the script at the logical standby database that was most recently in the primary role (database P) has been applied to each physical standby database.
  - At each step of the downgrade procedure where an action other than running a script is performed, first perform the step at the logical standby database that was most recently in the primary role (database P), and then perform the step at each physical standby database. Do not perform the next downgrade step at the logical standby database that was most recently in the primary role (database P) until the action has been performed at each physical standby database.

4. After the logical standby that was most recently in the primary role (database P) has been successfully downgraded, open it, and issue the following command:

```
SQL> ALTER DATABASE ACTIVATE LOGICAL STANDBY DATABASE;
```

Database P is now back in the primary role.

5. At each of the logical standby databases in the configuration, issue the following command (note that the command requires that a database link back to the primary exist in all of the logical standby databases):



```
SQL> ALTER DATABASE START LOGICAL STANDBY APPLY IMMEDIATE NEW PRIMARY  
prim_db_link;
```

# C

## Data Type and DDL Support on a Logical Standby Database

When setting up a logical standby database, you must ensure the logical standby database can maintain the datatypes and tables in your primary database.

The following topics describe the various database objects, storage types, and PL/SQL supplied packages that are supported and unsupported by logical standby databases:

- [Datatype Considerations](#)
- [Support for Data Types That Lack Native Redo-Based Support](#)
- [Support for Transparent Data Encryption \(TDE\)](#)
- [Support for Tablespace Encryption](#)
- [Support For Row-level Security and Fine-Grained Auditing](#)
- [Oracle Label Security](#)
- [Oracle E-Business Suite](#)
- [Supported Table Storage Types](#)
- [Unsupported Table Storage Types](#)
- [PL/SQL Supplied Packages Considerations](#)
- [Unsupported Tables](#)
- [Skipped SQL Statements on a Logical Standby Database](#)
- [DDL Statements Supported by a Logical Standby Database](#)
- [Distributed Transactions and XA Support](#)
- [Support for SecureFiles LOBs](#)
- [Support for Database File System \(DBFS\)](#)
- [Character Set Considerations](#)
- [Additional PL/SQL Package Support Available Only in the Context of DBMS\\_ROLLING Upgrades](#)

### C.1 Datatype Considerations

See these topics for information about supported and unsupported database objects.

- [Supported Datatypes in a Logical Standby Database](#)
- [Unsupported Datatypes in a Logical Standby Database](#)

## C.1.1 Supported Datatypes in a Logical Standby Database

These are the datatypes that logical standby databases support.

Logical standby databases support the following datatypes:

- Abstract Data Types (ADTs) and ADT tables
  - ADTs cannot contain any data types that are not supported as a top-level column type (for example, nested tables, PKREFs, BFILE, unsupported opaque types).
  - For a table with ADT columns to be supported there must be a primary key (or at least a unique constraint or unique index) that consists solely of scalar top-level columns (scalar ADT attributes cannot be part of such a candidate key).
- BINARY\_DOUBLE
- BINARY\_FLOAT
- BLOB, CLOB, and NCLOB stored as BasicFile and SecureFiles. SecureFiles can be compressed, encrypted, or deduplicated. SecureFiles support requires that the primary database be running at a compatibility of 11.2 or higher. See [Support for SecureFiles LOBs](#)
- CHAR
- DATE
- INTERVAL YEAR TO MONTH
- INTERVAL DAY TO SECOND
- LONG
- LONG RAW
- NCHAR
- NUMBER
- NVARCHAR2
- Objects stored as VARRAYS (except for Collections)
- Oracle Text
- RAW
- Multimedia (See exceptions listed in [Unsupported Datatypes in a Logical Standby Database.](#)):
  - ORDAudio
  - ORDDataSource (internal)
  - ORDDicom
  - ORDDoc
  - ORDImage
  - ORDSource (internal)
  - ORDVideo

- Spatial (See exceptions listed in [Unsupported Datatypes in a Logical Standby Database](#).)
- TIMESTAMP
- TIMESTAMP WITH TIMEZONE
- TIMESTAMP WITH LOCAL TIMEZONE
- VARCHAR and VARCHAR2
- XMLType data for all storage models, assuming the following primary database compatibility requirements:
  - XMLType stored in CLOB format requires that the primary database be run at a compatibility setting of 11.0 or higher (XMLType stored as CLOB is deprecated as of Oracle Database 12c Release 1 (12.1).)
  - XMLType stored in object-relational format or as binary XML requires that the primary database be running Oracle Database 11g Release 2 (11.2.0.3) or higher with a redo compatibility setting of 11.2.0.3 or higher

 **Note:**

SQL Apply does not support statements that have function calls that perform DML on ADT, LOB, or XMLType columns.

 **Note:**

As of Oracle Database 12c Release 1 (12.1), the maximum size of the VARCHAR2, NVARCHAR2, and RAW datatypes has been increased to 32 KB when the COMPATIBLE initialization parameter is set to 12.0 or later and the MAX\_STRING\_SIZE initialization parameter is set to EXTENDED. Logical standby databases support this increased size in most cases. See "[Ensure Table Rows in the Primary Database Can Be Uniquely Identified](#)" for known restrictions.

### C.1.1.1 Compatibility Requirements

SQL Apply support for these features has compatibility requirements on the primary database:

- Multibyte CLOB support requires primary database to run at a compatibility of 10.1 or higher.
- IOT support without LOBs and Overflows requires primary database to run at a compatibility of 10.1 or higher.
- IOT support with LOB and Overflow requires primary database to run at a compatibility of 10.2 or higher.
- TDE support requires primary database to run at a compatibility of 11.1 or higher.
- Basic compression and advanced row compression require the primary database to run at a compatibility of 11.1 or higher.

- Hybrid Columnar Compression support is dependent on the underlying storage system.

 **See Also:**

- *Oracle Database Concepts* for more information about Hybrid Columnar Compression

### C.1.1.2 Opaque Type Restrictions

These are the restrictions regarding opaque types.

- `SYS.ANYDATA` is supported as long as the instance does not store user-defined opaque data types or `BFILES`.
- `SYS.ANYDATASET`, `SYS.ANYTYPE`, and user-defined opaque types are not supported.

### C.1.2 Unsupported Datatypes in a Logical Standby Database

Some data types are not supported by logical standby databases.

If a table contains columns having any of the following unsupported data types, then the entire table is ignored by SQL Apply. (See [Support for Data Types That Lack Native Redo-Based Support](#) for information about support for data types that lack native redo-based support.)

- `ROWID`, `UROWID`

Note that only logical `UROWID` columns are supported. Non-logical `UROWID` are detected at run-time, the DML is skipped, and a trace message is written to the report file.

- Nested tables
- Objects with nested tables
- Identity columns

## C.2 Support for Data Types That Lack Native Redo-Based Support

The Extended Datatype Support (EDS) feature provides a mechanism for logical standbys to support certain data types that lack native redo-based support.

 **Note:**

As of Oracle Database 18c, Extended Datatype Support (EDS) is deprecated. All EDS-supported Oracle data types are now supported natively by logical standbys or Oracle GoldenGate.

For example, tables with `SDO_GEOMETRY` columns can be replicated using EDS. (Source tables must have a primary key.)

You can query the `DBA_LOGSTDBY_EDS_SUPPORTED` view to find out which tables are candidates for EDS.

## C.3 Support for Transparent Data Encryption (TDE)

Oracle Data Guard SQL Apply can be used to provide data protection for a primary database with Transparent Data Encryption (TDE) enabled.

Consider the following when using a logical standby database to provide data protection for applications with advanced security requirements:

- Tables with Transparent Data Encryption using server held keys are replicated on a logical standby database when both the primary and the standby databases are running at a compatibility level of 11.1 or higher.
- Transparent Data Encryption in the context of Hardware Security Modules is supported for logical standby databases in Oracle Database 11g Release 2 (11.2) and later.

You must consider the following restrictions when, in the context of a logical standby database, you want to replicate tables that have encrypted columns:

1. To translate encrypted redo records, SQL Apply must have access to an open wallet containing the Transparent Data Encryption keys. Therefore, you must copy the wallet containing the keys from the primary database to the standby database after it has been created.
2. The wallet must be copied from the primary database to the logical standby database every time the master key is changed.
3. Oracle recommends that you not rekey the master key at the logical standby database while the logical standby database is replicating encrypted tables from the primary database. Doing so may cause SQL Apply to halt when it encounters an encrypted redo record.
4. You can rekey the encryption key of a replicated table at the logical standby database. This requires that you lower the guard setting to `NONE` before you issue the rekey command.
5. Replicated encrypted tables can use a different encryption scheme for columns than the one used in the primary database. For example, if the `SALARY` column of the `HR.EMPLOYEES` table is encrypted at the primary database using the AES192 encryption algorithm, it can be encrypted at the logical standby using the AES256 encryption algorithm. Or, the `SALARY` column can remain unencrypted at the logical standby database.

## C.4 Support for Tablespace Encryption

Oracle Data Guard SQL Apply can be used to provide data protection for a primary database that has tablespace encryption enabled.

In such a case, restrictions 1, 2, and 3 listed in [Support for Transparent Data Encryption \(TDE\)](#) apply.

Encryption, re-keying, or decryption of a tablespace on a primary does not trigger the need for the same operation on a logical standby. However, a logical standby must have the capability of re-keying as well.

 **Note:**

In some cases, when SQL Apply mines and applies redo records for changes made to tables in encrypted tablespaces, records of user data in unencrypted form may be kept for a long period of time. If this is not acceptable, then issue the following command to move all metadata tables pertaining to the mining component of SQL Apply to an encrypted tablespace:

```
SQL> DBMS_LOGMNR_D.SET_TABLESPACE(NEW_TABLESPACE =>
'ENCRYPTED_LOGMNR_TS');
```

## C.5 Support For Row-level Security and Fine-Grained Auditing

As of Oracle Database 11g, logical standby can automatically replicate the security environment provided through the `DBMS_RLS` and `DBMS_FGA` PL/SQL packages.

This support simplifies management of security considerations when a server fails over to the standby since the security environment is transparently maintained. It also ensures that access control policies applied to the primary data can be automatically forwarded to the standby, and the standby data transparently given the same level of protection. If a standby server is newly created with 11g, this replication is enabled by default; otherwise it has to be enabled by the DBA at an appropriate time.

Support for the replication of these PL/SQL packages requires that both the primary and the standby be running with a compatibility setting of 11.1 or higher.

It also requires that the table referenced be a Logical Standby maintained object. For example, a table with a rowid column does not have its data maintained by Logical Standby, so `DBMS_RLS` and `DBMS_FGA` calls referencing that table are not maintained.

### C.5.1 Row-level Security

Row-Level Security, also known as Virtual Private Database (VPD), is a feature that enforces security at a fine level of granularity, when accessing tables, views, or synonyms.

When a user directly or indirectly accesses a table, view, or synonym protected with a VPD policy, the server dynamically modifies the SQL statement of the user. The modification creates a `WHERE` condition (known as a predicate) returned by a function implementing the security policy. The statement is modified dynamically, transparently to the user, using any condition that can be expressed in, or returned by, a function. VPD policies can be applied to `SELECT`, `INSERT`, `UPDATE`, `INDEX`, and `DELETE` statements. VPD is implemented by using the `DBMS_RLS` package to apply security policies.

When a `DBMS_RLS` procedure is executed on the primary, additional information is captured in the redo that allows the procedure call to be logically reconstructed and executed on the standby. Logical Standby supports replication of ancillary objects for VPD such as Contexts, Database Logon Triggers, and their supporting packages. You must ensure that these objects are placed in maintained schemas and that no DDL skips have been configured that would stop their replication.

## C.5.2 Fine-Grained Auditing

Fine-grained auditing provides a way to audit select statements.

The `DBMS_FGA` package enables all select statements that access a table to be captured, together with what data was accessed. An FGA policy may be applied to a particular column or even to only those select statements that return rows for which a specified predicate returns `TRUE`.

When a `DBMS_FGA` procedure is executed on the primary, additional information is captured to the redo that allows the procedure call to be logically reconstructed and executed on the standby.

## C.5.3 Skipping and Enabling PL/SQL Replication

PL/SQL can be configured with `skip` and `skip_error` rules exactly as DDL statements except that the use of wildcards on the package and procedure are not supported.

For example to skip all aspects of VPD, do the following:

```
DBMS_LOGSTDBY.Skip (  
  stmt => 'PL/SQL',  
  schema_name => 'SYS',  
  object_name => 'DBMS_RLS',  
  use_like => FALSE);
```

The schema specified is the schema in which the package is defined. To skip an individual procedure in a package, the syntax is as follows:

```
DBMS_LOGSTDBY.Skip (  
  stmt => 'PL/SQL',  
  schema_name => 'SYS',  
  object_name => 'DBMS_RLS.ADD_POLICY',  
  use_like => FALSE);
```

To skip VPD on certain schemas or tables, a skip procedure must be used. The skip procedure is passed the fully qualified PL/SQL statement that is to be executed, for example:

```
DBMS_RLS.DROP_POLICY(  
  object_schema => 'SCOTT',  
  object_name => 'EMP',  
  policy_name => 'MYPOLICY');
```

The procedure could then parse the statement to decide whether to skip it, to apply it, or to stop apply and let the DBA take a compensating action.

Unlike DDL, skip procedures on PL/SQL do not support returning a replacement statement.



## C.6 Oracle Label Security

As of Oracle Database 12c Release 2 (12.2), you can upgrade databases that use Oracle Label Security (OLS) to new Oracle Database releases and patch sets using Oracle Data Guard database rolling upgrades with a transient logical standby database and the PL/SQL package, `DBMS_ROLLING`.

## C.7 Oracle Database Vault

Oracle Data Guard rolling upgrades support databases that use Oracle Database Vault.

As of Oracle Database 12c Release 2 (12.2.0.1), you can upgrade databases that use Oracle Database Vault to new Oracle Database releases and patch sets by using Oracle Data Guard database rolling upgrades with a transient logical standby and the PL/SQL package, `DBMS_ROLLING`.

## C.8 Oracle E-Business Suite

Logical standby databases do not fully support an Oracle E-Business Suite implementation because there are tables that contain unsupported data types.

However, using `SKIP` rules, it is possible for you to replicate a subset of the E-Business Suite schemas and tables to offload applications to the logical standby.

### See Also:

The My Oracle Support note 851603.1 at <http://support.oracle.com> for additional information about using Logical standby with Oracle E-Business Suite

## C.9 Supported Table Storage Types

Logical standby databases support several table storage types.

- Cluster tables (including index clusters and heap clusters).
- Index-organized tables (partitioned and nonpartitioned, including overflow segments).
- Heap-organized tables (partitioned and nonpartitioned).
- Advanced row compression and basic table compression. Both of these options require that the compatibility setting of the primary database be set to 11.1.0 or higher.
- Tables containing LOB columns stored as SecureFiles, when compatibility is set to 11.2 or higher.
- Tables using Hybrid Columnar Compression, when compatibility is set to 11.2.0.2 or higher.

 **See Also:**

- [Oracle Database Concepts](#) for more information about Hybrid Columnar Compression
- Tables with virtual columns (provided the table has no other columns or properties not supported by logical standby)
  - If there is no primary key and no non-null unique constraint or index, then all columns with a declared maximum length of 4000 bytes are logged as part of the `UPDATE` statement to help identify the modified row. For the purpose of row identification, logical standby requires that a table have at least one visible (not virtual) column of one of the following datatypes:
    - CHAR
    - VARCHAR
    - VARCHAR2 (with a declared column length  $\leq$  4000 bytes)
    - NVARCHAR
    - NVARCHAR2 (with a declared column length  $\leq$  4000 bytes)
    - NUMBER
    - DATE
    - RAW
    - BINARY FLOAT
    - BINARY DOUBLE
    - TIMESTAMP
    - TIMESTAMP WITH TIME ZONE
    - TIMESTAMP WITH LOCAL TIME ZONE
    - INTERVAL YEAR TO MONTH
    - INTERVAL DAY TO SECOND

 **See Also:**

- [Ensure Table Rows in the Primary Database Can Be Uniquely Identified](#)

## C.10 Unsupported Table Storage Types

If a table contains *only* these datatypes, then logical standby does not support it.

- LOB (CLOB, NCLOB, BLOB)
- LONG
- LONG RAW

- OBJECT TYPE
- COLLECTIONS
- XML
- VARCHAR2 (with a declared column length > 4000 bytes)
- NVARCHAR2 (with a declared column length > 4000 bytes)
- RAW (with a declared column length > 4000 bytes)

 **See Also:**

- [Support for SecureFiles LOBs](#)
- [Ensure Table Rows in the Primary Database Can Be Uniquely Identified](#)

## C.10.1 Unsupported Tables as a Result of Partitioning

Logical standby does not support tables that use system partitioning or reference partitioning.

When possible, the `ATTRIBUTES` column of the `DBA_LOGSTDBY_UNSUPPORTED` view displays the reason why a table is not supported by SQL Apply. The `ATTRIBUTES` column may be NULL if the table structure itself is not supported by SQL Apply (for example, the table is system-partitioned).

## C.11 PL/SQL Supplied Packages Considerations

Keep these considerations in mind regarding supported and unsupported PL/SQL supplied packages.

- [Supported PL/SQL Supplied Packages](#)
- [Unsupported PL/SQL Supplied Packages](#)
- [Handling XML and XDB PL/SQL Packages in Logical Standby](#)

 **See Also:**

*Oracle Database PL/SQL Packages and Types Reference* for more information about Oracle PL/SQL supplied packages

### C.11.1 Supported PL/SQL Supplied Packages

Oracle PL/SQL supplied packages that do not modify system metadata or user data leave no footprint in the archived redo log files, and hence are safe to use on the primary database.

Examples of such packages are `DBMS_OUTPUT`, `DBMS_RANDOM`, `DBMS_PIPE`, `DBMS_DESCRIBE`, `DBMS_TRACE`, `DBMS_METADATA`, `DBMS_CRYPT`.

Oracle PL/SQL supplied packages that do not modify system metadata but may modify user data are supported by SQL Apply, as long as the modified data belongs to the supported data types listed in [Supported Datatypes in a Logical Standby Database](#). Examples of such packages are DBMS\_LOB, DBMS\_SQL, and DBMS\_TRANSACTION.

Oracle Data Guard logical standby supports replication of actions performed through the following packages: DBMS\_DDL, DBMS\_FGA, SDO\_META, DBMS\_REDACT, DBMS\_REDEFINITION, DBMS\_RLS, DBMS\_SQL\_TRANSLATOR, DBMS\_XDS, DBMS\_XMLINDEX and DBMS\_XMLSCHEMA.

To identify which packages are supported in logical standby, you can query the DBA\_LOGSTDBY\_PLSQL\_SUPPORT view. For example, you can run the following query to find out which packages are supported in a generic logical standby:

```
SQL> SELECT OWNER, PKG_NAME FROM DBA_LOGSTDBY_PLSQL_SUPPORT -  
> where support_level = 'ALWAYS';
```

To identify which packages are supported in the context of rolling upgrades done using the DBMS\_ROLLING package, you can query the DBA\_LOGSTDBY\_PLSQL\_SUPPORT view, as follows:

```
SQL> SELECT OWNER, PKG_NAME FROM DBA_LOGSTDBY_PLSQL_SUPPORT -  
> where support_level = 'DBMS_ROLLING';
```

## C.11.2 Unsupported PL/SQL Supplied Packages

Oracle PL/SQL supplied packages that modify system metadata typically are not supported by SQL Apply, and therefore their effects are not visible on the logical standby database.

Examples of such packages are DBMS\_JAVA, DBMS\_REGISTRY, DBMS\_ALERT, DBMS\_SPACE\_ADMIN, DBMS\_REFRESH, and DBMS\_AQ.

Additionally, the DBMS\_RESOURCE\_MANAGER package is not supported for physical standby rolling upgrades.

### C.11.2.1 Support for DBMS\_JOB

Specific support for DBMS\_JOB has been provided. Jobs created on the primary database are replicated on the standby database, but are not run as long as the standby maintains its standby role.

In the event of a switchover or failover, jobs scheduled on the original primary database automatically begin running on the new primary database.

You can also create jobs at the logical standby. These jobs only run as long as the logical standby maintains its standby role.

### C.11.2.2 Support for DBMS\_SCHEDULER

Specific support for DBMS\_SCHEDULER has been provided to allow jobs to be run on a standby database.

A new attribute of a scheduler job has been created in Oracle Database 11g called `database_role` whose contents match the `database_role` attribute of `V$DATABASE`. When a scheduler job is created, it defaults to the local role, so a job created on

the standby defaults to a `database_role` of `LOGICAL STANDBY`. The job scheduler executes only jobs specific to the current role. On switchover or failover, the scheduler automatically switches to running jobs specific to the new role.

Scheduler jobs are not replicated to the standby, except in the context of a rolling upgrade done using the `DBMS_ROLLING` PL/SQL package. However, existing jobs can be activated under the new role by using the `DBMS_SCHEDULER.Set_Attribute` procedure. Alternatively, jobs that should run in both roles can be cloned and the copy made specific to the other role. The `DBA_SCHEDULER_JOB_ROLES` view shows which jobs are specific to which role.

Scheduler jobs obey the database guard when they run on a logical standby database. Thus, to run jobs that need to modify unmaintained tables, set the database guard to `STANDBY`. (It is not possible to use the `ALTER SESSION DISABLE GUARD` statement inside a PL/SQL block and have it take effect.)

### C.11.3 Handling XML and XDB PL/SQL Packages in Logical Standby

Logical Standby supports `XMLType` data for all storage models, with some compatibility requirements.

The requirements are as follows:

- `XMLType` stored in `CLOB` format requires that the primary database be run at a compatibility setting of 11.0 or higher (`XMLType` stored as `CLOB` is deprecated as of Oracle Database 12c Release 1 (12.1).)
- `XMLType` stored in object-relational format or as binary XML requires that the primary database be running Oracle Database 11g Release 2 (11.2.0.3) or higher with a redo compatibility setting of 11.2.0.3 or higher

There are several PL/SQL packages used in conjunction with XML that are not fully supported.

The PL/SQL packages and procedures that are supported by Logical Standby only modify in-memory structures; they do not modify data stored in the database. These packages do not generate redo and therefore are not replicated to a Logical Standby.

Certain PL/SQL packages and procedures related to XML and XDB that are not supported by Logical Standby, but that require corresponding invocations at the logical standby database for replication activities to continue, are instrumented such that invocations of these procedures at the primary database generate additional redo records indicating procedure invocation. When SQL Apply encounters such redo records, it stops and writes an error message in the `DBA_LOGSTDBY_EVENTS` table, indicating the procedure name. This allows the DBA to invoke the corresponding procedure at the logical standby database at the appropriate time so that subsequent redo records generated at the primary database can be applied successfully at the logical standby database. See [The DBMS\\_XMLSCHEMA Schema through Compensating for Ordering Sensitive Unsupported PL/SQL](#) for more information about dealing with these unsupported procedures.

The following packages contain unsupported procedures:

- `DBMS_XMLSCHEMA` (Supported if compatibility is set to 12.0.0 or higher.)
- `DBMS_XMLINDEX`

In addition to these packages, Logical Standby does not support any modifications to the XDB schema. The objects within the XDB schema are considered to be system metadata and direct modifications to them are not replicated.

Tables managed by the Oracle XML DB Repository, also known as hierarchy-enabled tables, are not supported by Logical Standby. These tables are used to store XML data and can be accessed using the FTP and HTTP protocols, as well as the normal SQL access. For more information on these tables, refer to the *Oracle XML DB Developer's Guide*.

### C.11.3.1 The DBMS\_XMLSCHEMA Schema

Certain procedures within the DBMS\_XMLSCHEMA package are unsupported and cannot be replicated by Logical Standby.

Logical Standby stops when it encounters calls to these procedures to provide the user an opportunity to take a compensating action for these calls. Sections [Dealing With Unsupported PL/SQL Procedures](#) through [Compensating for Ordering Sensitive Unsupported PL/SQL](#) provide more information on the alternatives available for dealing with these unsupported procedures:

- COPYEVOLVE
- INPLACEEVOLVE
- COMPILESCHEMA

The XDB schema is an Oracle-managed schema. Any changes to this schema are automatically skipped by Logical Standby. The following procedure makes changes to the XDB schema which do not get replicated:

- GENERATEBEAN

### C.11.3.2 The DBMS\_XMLINDEX Package

All procedures in the DBMS\_XMLINDEX package are supported except for these.

- DBMS\_XMLINDEX.REGISTERPARAMETER
- DBMS\_XMLINDEX.MODIFYPARAMETER
- DBMS\_XMLINDEX.DROPPARAMETER

### C.11.3.3 Dealing With Unsupported PL/SQL Procedures

There are a couple options for dealing with unsupported PL/SQL procedures.

The first option is to allow the Logical Standby apply process to stop and to manually perform some compensating action. The second option is to take a preemptive action and to skip the unsupported PL/SQL either by using Logical Standby skip procedures. Each of these options is discussed in the following sections.

### C.11.3.4 Manually Compensating for Unsupported PL/SQL

When Logical Standby encounters something that is unsupported, it stops the apply process and records an error in the DBA\_LOGSTDBY\_EVENTS table.

You can query this table to determine what action caused the standby to stop and what action, if any, needs to be taken to compensate.

The following example shows a sample of what this query and its output might look like:

```
select status, event from dba_logstdby_events
       where commit_scn >= (select applied_scn from dba_logstdby_progress) and
       status_code = 16265
       order by commit_scn desc;
```

```
STATUS
-----
EVENT
-----
ORA-16265: Unsupported PL/SQL procedure encountered
begin
"XDB"."DBMS_XMLSCHEMA"."REGISTERPARAMETER" (
  "NAME" => 'myIndexParam',
  "PARAMETER" => 'PATH TABLE

ORA-16265: Unsupported PL/SQL procedure encountered
begin
"XDB"."DBMS_XMLSCHEMA"."REGISTERPARAMETER" (
  "NAME" => 'myIndexParam',
  "PARAMETER" => 'PATH TABLE

2 rows selected.
```

Two rows with the same information are returned because Logical Standby automatically retries the failed transaction. The results show that the standby was stopped when a call to `DBMS_XMLSCHEMA.REGISTERSCHEMA` was encountered for the `xmlplsqsch2` schema. You can use this information to transfer any needed files from the primary and register the schema on the standby.

Once the schema has been successfully registered on the standby, the apply process on the Logical Standby can be restarted. This must be performed using the `SKIP FAILED TRANSACTION` option, for example:

```
alter database start logical standby apply skip failed transaction'
```

Logical Standby skips past the offending transaction and continues applying redo from the primary.

The general procedure for manually replicating unsupported PL/SQL follows these steps:

1. Some unsupported PL/SQL is executed on the primary database.
2. The standby database encounters the unsupported PL/SQL and stops Apply.
3. You examine the `DBA_LOGSTDBY_EVENTS` table to determine what caused Apply to stop.
4. You execute some compensating actions on the standby for the unsupported PL/SQL.
5. You restart apply on the standby.

### C.11.3.5 Compensating for Ordering Sensitive Unsupported PL/SQL

Although the previous approach is useful, it cannot be used in all cases. It can only be safely used when the time that the PL/SQL is executed relative to other transactions is not critical. One case that this should not be used for is that of

DBMS\_XMLSCHEMA.copyEvolve. The DBMS\_XMLSCHEMA.copyEvolve procedure evolves, or changes, a schema and can modify tables by adding and or removing columns and it can also change whether or not XML documents are valid. The timing of when this procedure should be executed on the Logical Standby is critical. The only time guaranteed to be safe is when apply has stopped on the Logical Standby when it sees that this procedure was executed on the primary database.

Before evolving a schema, it is also important to quiesce any traffic on the primary that may be using the schema. Otherwise, a transaction that is executed close in time to the evolveSchema on the primary may be executed in a different order on the Logical Standby because the dependency between the two transactions is not apparent to the Logical Standby. Therefore, when ordering sensitive PL/SQL is involved, you should follow these steps:

1. Quiesce changes to dependent tables on the primary.
2. Execute the CopyEvolve on the primary.
3. Wait for the standby to stop on the CopyEvolve PL/SQL.
4. Apply the compensating CopyEvolve on the standby.
5. Restart apply on the standby.

Example C-1 shows a sample of the procedures that could be used to determine how to handle RegisterSchema calls.

### Example C-1 PL/SQL Skip Procedure for RegisterSchema

```
-- Procedures to determine how to handle registerSchema calls

-- This procedure extracts the schema URL, or name, from the statement
-- string that is passed into the skip procedure.

Create or replace procedure sec_mgr.parse_schema_str(
    statement          in varchar2,
    schema_name       out varchar2)
Is
    pos1 number;
    pos2 number;
    workingstr  varchar2(32767);
Begin

    -- Find the correct argument
    pos1 := instr(statement, 'SCHEMAURL' => '');
    workingstr := substr(statement, pos1 + 16);

    -- Find the end of the schema name
    pos1 := instr(workingstr, '');

    -- Get just the schema name
    workingstr := substr(workingstr, 1, pos1 - 1);

    schema_name := workingstr;

End parse_schema_str;
/
show errors

-- This procedure checks if a schema is already registered. If so,
-- it returns the value DBMS_LOGSTDBY.SKIP_ACTION_SKIP to indicate that
```



```

-- the PL/SQL should be skipped. Otherwise, the value
-- DBMS_LOGSTDBY.SKIP_ACTION_SKIP is returned and Logical Standby apply
-- will halt to allow the DBA to deal with the registerSchema call.

Create or replace procedure sec_mgr.skip_registerschema(
  statement          in varchar2,
  package_owner      in varchar2,
  package_name       in varchar2,
  procedure_name     in varchar2,
  current_user       in varchar2,
  xidusn             in number,
  xidslt             in number,
  xidsqn             in number,
  exit_status        in number,
  skip_action        out number)
Is
  schema_exists number;
  schemastr varchar2(2000);
Begin

  skip_action := DBMS_LOGSTDBY.SKIP_ACTION_SKIP;

  -- get the schame name from statement
  parse_schema_str(statement, schemastr);

  -- see if the schema is already registered
  select count(*) into schema_exists from sys.all_xml_schemas s
        where s.schema_url = schemastr and
              s.owner = current_user;

  IF schema_exists = 0 THEN
    -- if the schema is not registered, then we must stop apply
    skip_action := DBMS_LOGSTDBY.SKIP_ACTION_APPLY;
  ELSE
    -- if the schema is already registered, then we can skip this statement
    skip_action := DBMS_LOGSTDBY.SKIP_ACTION_SKIP;
  END IF;

End skip_registerschema;
/
show errors

-- Register the skip procedure to deal with the unsupported registerSchema
-- PL/SQL.
Begin
  sys.dbms_logstdby.skip(stmt => 'PL/SQL',
    schema_name => 'XDB',
    object_name => 'DBMS_XMLSCHEMA.REGISTERSHEMA',
    proc_name   => 'SEC_MGR.SKIP_REGISTERSHEMA',
    use_like    => FALSE );
  End;
/
show errors

```

## C.12 Unsupported Tables

It is important to identify unsupported database objects on the primary database before you create a logical standby database.

This is because changes made to unsupported data types and tables on the primary database are automatically skipped by SQL Apply on the logical standby database. Moreover, no error message is returned.

 **Note:**

Starting with Oracle Database Release 12.2, new types or features, including long identifiers, are only supported for logical replication using the DBMS\_ROLLING package or Oracle Golden Gate.

 **Note:**

Sorted hash cluster tables are not supported on logical standby databases.

There are three types of objects on a database, from the perspective of logical standby support:

- Objects that are explicitly maintained by SQL Apply
- Objects that are implicitly maintained by SQL Apply
- Objects that are not maintained by SQL Apply

Some schemas that ship with the Oracle database (for example, *SYSTEM*) contain objects that are implicitly maintained by SQL Apply. However, if you put a user-defined table in *SYSTEM*, then it is not maintained even if it has columns of supported data types. To discover which objects are not maintained by SQL Apply, you must run two queries. The first query is as follows:

```
SQL> SELECT OWNER FROM DBA_LOGSTDBY_SKIP WHERE STATEMENT_OPT = 'INTERNAL SCHEMA';
```

This returns all schemas that are considered to be internal. User tables placed in these schemas are not replicated on a logical standby database and do not show up in the *DBA\_LOGSTDBY\_UNSUPPORTED* view. Tables in these schemas that are created by Oracle are maintained on a logical standby, if the feature implemented in the schema is supported in the context of logical standby.

The second query you must run is as follows. It returns tables that do not belong to internal schemas and are not maintained by SQL Apply because of unsupported data types:

```
SQL> SELECT DISTINCT OWNER, TABLE_NAME FROM DBA_LOGSTDBY_UNSUPPORTED -
> ORDER BY OWNER, TABLE_NAME;
```

| OWNER | TABLE_NAME |
|-------|------------|
| HR    | COUNTRIES  |
| OE    | ORDERS     |
| OE    | CUSTOMERS  |
| OE    | WAREHOUSES |

To view the column names and data types for one of the tables listed in the previous query, use a *SELECT* statement similar to the following:

```
SQL> SELECT COLUMN_NAME,DATA_TYPE FROM DBA_LOGSTDBY_UNSUPPORTED -
> WHERE OWNER='OE' AND TABLE_NAME = 'CUSTOMERS';
```

| COLUMN_NAME       | DATA_TYPE        |
|-------------------|------------------|
| -----             | -----            |
| CUST_ADDRESS      | CUST_ADDRESS_TYP |
| PHONE_NUMBERS     | PHONE_LIST_TYP   |
| CUST_GEO_LOCATION | SDO_GEOMETRY     |

If the primary database contains unsupported tables, SQL Apply automatically excludes these tables when applying redo data to the logical standby database.



#### Note:

For the queries shown in this section, if you are working in a multitenant container database (CDB) environment, then many DBA views have analogous CDB views that you should use instead. For example, you would query the `CDB_LOGSTDBY_SKIP` view instead of the `DBA_LOGSTDBY_SKIP` view.

## C.12.1 Unsupported Tables During Rolling Upgrades

Before you perform a rolling upgrade, determine whether any of the tables involved contain data types that are unsupported on logical standby databases.

To do this, you can query either the `DBA_LOGSTDBY_UNSUPPORTED` view or the `DBA_ROLLING_UNSUPPORTED` view, depending on the type of rolling upgrade being performed.

If you are performing a rolling upgrade using the `DBMS_ROLLING` PL/SQL package, as described in [Using DBMS\\_ROLLING to Perform a Rolling Upgrade](#), then query the `DBA_ROLLING_UNSUPPORTED` view.

If you are not using the `DBMS_ROLLING` package, but are instead following the manual process outlined in [Using SQL Apply to Upgrade the Oracle Database](#), then query the `DBA_LOGSTDBY_UNSUPPORTED` view.

A rolling upgrade performed using `DBMS_ROLLING` supports more object types than a manual rolling upgrade operation. For example, only upgrades performed with `DBMS_ROLLING` support queue tables. Additionally, a rolling upgrade performed using `DBMS_ROLLING` also supports more PL/SQL packages.

 **See Also:**

- [Using SQL Apply to Upgrade the Oracle Database](#) for more information about performing manual rolling upgrades
- [Using DBMS\\_ROLLING to Perform a Rolling Upgrade](#) for more information about performing rolling upgrades using the DBMS\_ROLLING PL/SQL package
- [Additional PL/SQL Package Support Available Only in the Context of DBMS\\_ROLLING Upgrades](#) for information about PL/SQL package support available only in the context of DBMS\_ROLLING upgrades
- *Oracle Database PL/SQL Packages and Types Reference* for a description of the DBMS\_ROLLING PL/SQL package
- *Oracle Database Reference* for complete information about views

## C.12.2 Unsupported Tables As a Result of DML Performed In a PL/SQL Function

If, during an insert or update DML operation on a supported table, an out-of-line column (LOB, XMLType, or ADT) is modified through a PL/SQL function and that function in turn performs DML on another table in the course of its execution, then the redo patterns generated are unsupported by LogMiner.

As a result, redo for such a workload cannot be reliably mined using LogMiner.

## C.13 Skipped SQL Statements on a Logical Standby Database

By default, certain SQL statements are automatically skipped by SQL Apply.

The affected statements are as follows:

```
ALTER DATABASE
ALTER MATERIALIZED VIEW
ALTER MATERIALIZED VIEW LOG
ALTER SESSION
ALTER SYSTEM
CREATE CONTROL FILE
CREATE DATABASE
CREATE DATABASE LINK
CREATE PFILE FROM SPFILE
CREATE MATERIALIZED VIEW
CREATE MATERIALIZED VIEW LOG
CREATE SCHEMA AUTHORIZATION
CREATE SPFILE FROM PFILE
DROP DATABASE LINK
DROP MATERIALIZED VIEW
```

```
DROP MATERIALIZED VIEW LOG
EXPLAIN
LOCK TABLE
PURGE DBA_RECYCLEBIN
PURGE INDEX
SET CONSTRAINTS
SET ROLE
SET TRANSACTION
```

All other SQL statements executed on the primary database are applied to the logical standby database.

## C.14 DDL Statements Supported by a Logical Standby Database

The `DBMS_LOGSTDBY.SKIP` procedure has several optional keywords.

[Table C-1](#) lists the supported values for the `stmt` parameter of the `DBMS_LOGSTDBY.SKIP` procedure. The left column of the table lists the keywords that may be used to identify the set of SQL statements to the right of the keyword. In addition, any of the SQL statements listed in the `sys.audit_actions` table (shown in the right column of [Table 1-13](#)) are also valid values. Keywords are generally defined by database object.

### See Also:

*Oracle Database PL/SQL Packages and Types Reference* for complete information about the `DBMS_LOGSTDBY` package and [Setting up a Skip Handler for a DDL Statement](#)

**Table C-1 Values for `stmt` Parameter of the `DBMS_LOGSTDBY.SKIP` procedure**

| Keyword                                               | Associated SQL Statements                                            |
|-------------------------------------------------------|----------------------------------------------------------------------|
| There is no keyword for this group of SQL statements. | GRANT<br>REVOKE<br>ANALYZE TABLE<br>ANALYZE INDEX<br>ANALYZE CLUSTER |
| CLUSTER                                               | AUDIT CLUSTER<br>CREATE CLUSTER<br>DROP CLUSTER<br>TRUNCATE CLUSTER  |
| CONTEXT                                               | CREATE CONTEXT<br>DROP CONTEXT                                       |

**Table C-1 (Cont.) Values for stmt Parameter of the DBMS\_LOGSTDBY.SKIP procedure**

| Keyword                | Associated SQL Statements                                                                                                                                                                                                                                          |
|------------------------|--------------------------------------------------------------------------------------------------------------------------------------------------------------------------------------------------------------------------------------------------------------------|
| DATABASE LINK          | CREATE DATABASE LINK<br>CREATE PUBLIC DATABASE LINK<br>DROP DATABASE LINK<br>DROP PUBLIC DATABASE LINK                                                                                                                                                             |
| DIMENSION              | ALTER DIMENSION<br>CREATE DIMENSION<br>DROP DIMENSION                                                                                                                                                                                                              |
| DIRECTORY              | CREATE DIRECTORY<br>DROP DIRECTORY                                                                                                                                                                                                                                 |
| DML                    | Includes DML statements on a table (for example: INSERT, UPDATE, and DELETE)                                                                                                                                                                                       |
| INDEX                  | ALTER INDEX<br>CREATE INDEX<br>DROP INDEX                                                                                                                                                                                                                          |
| NON_SCHEMA_DDL         | <i>All DDL that does not pertain to a particular schema</i><br><b>Note:</b> SCHEMA_NAME and OBJECT_NAME must be null                                                                                                                                               |
| PROCEDURE <sup>1</sup> | ALTER FUNCTION<br>ALTER PACKAGE<br>ALTER PACKAGE BODY<br>ALTER PROCEDURE<br>CREATE FUNCTION<br>CREATE LIBRARY<br>CREATE PACKAGE<br>CREATE PACKAGE BODY<br>CREATE PROCEDURE<br>DROP FUNCTION<br>DROP LIBRARY<br>DROP PACKAGE<br>DROP PACKAGE BODY<br>DROP PROCEDURE |
| PROFILE                | ALTER PROFILE<br>CREATE PROFILE<br>DROP PROFILE                                                                                                                                                                                                                    |
| PUBLIC DATABASE LINK   | CREATE PUBLIC DATABASE LINK<br>DROP PUBLIC DATABASE LINK                                                                                                                                                                                                           |
| PUBLIC SYNONYM         | CREATE PUBLIC SYNONYM<br>DROP PUBLIC SYNONYM                                                                                                                                                                                                                       |

**Table C-1 (Cont.) Values for stmt Parameter of the DBMS\_LOGSTDBY.SKIP procedure**

| Keyword          | Associated SQL Statements                                                                                                                                                             |
|------------------|---------------------------------------------------------------------------------------------------------------------------------------------------------------------------------------|
| ROLE             | ALTER ROLE<br>CREATE ROLE<br>DROP ROLE<br>SET ROLE                                                                                                                                    |
| ROLLBACK SEGMENT | ALTER ROLLBACK SEGMENT<br>CREATE ROLLBACK SEGMENT<br>DROP ROLLBACK SEGMENT                                                                                                            |
| SCHEMA_DDL       | <i>All DDL statements that create, modify, or drop schema objects (for example: tables, indexes, and columns)</i><br><b>Note:</b> SCHEMA_NAME and OBJECT_NAME must <i>not</i> be null |
| SEQUENCE         | ALTER SEQUENCE<br>CREATE SEQUENCE<br>DROP SEQUENCE                                                                                                                                    |
| SYNONYM          | CREATE PUBLIC SYNONYM<br>CREATE SYNONYM<br>DROP PUBLIC SYNONYM<br>DROP SYNONYM                                                                                                        |
| SYSTEM AUDIT     | AUDIT <i>SQL_statements</i><br>NOAUDIT <i>SQL_statements</i>                                                                                                                          |
| TABLE            | CREATE TABLE<br>ALTER TABLE<br>DROP TABLE<br>TRUNCATE TABLE                                                                                                                           |
| TABLESPACE       | CREATE TABLESPACE<br>DROP TABLESPACE<br>ALTER TABLESPACE                                                                                                                              |
| TRIGGER          | ALTER TRIGGER<br>CREATE TRIGGER<br>DISABLE ALL TRIGGERS<br>DISABLE TRIGGER<br>DROP TRIGGER<br>ENABLE ALL TRIGGERS<br>ENABLE TRIGGER                                                   |

**Table C-1 (Cont.) Values for stmt Parameter of the DBMS\_LOGSTDBY.SKIP procedure**

| Keyword | Associated SQL Statements                                                                       |
|---------|-------------------------------------------------------------------------------------------------|
| TYPE    | ALTER TYPE<br>ALTER TYPE BODY<br>CREATE TYPE<br>CREATE TYPE BODY<br>DROP TYPE<br>DROP TYPE BODY |
| USER    | ALTER USER<br>CREATE USER<br>DROP USER                                                          |
| VIEW    | CREATE VIEW<br>DROP VIEW                                                                        |

<sup>1</sup> Java schema objects (sources, classes, and resources) are considered the same as procedures for purposes of skipping (ignoring) SQL statements.

 **See Also:**

The following sections that provide usage examples of the SKIP and UNSKIP options:

- [Using DBMS\\_LOGSTDBY.SKIP to Prevent Changes to Specific Schema Objects](#)
- [Setting up a Skip Handler for a DDL Statement](#)
- [Modifying a Logical Standby Database](#)
- [Adding or Re-Creating Tables On a Logical Standby Database](#)

## C.14.1 DDL Statements that Use DBLINKS

SQL Apply may not correctly apply DDL statements that reference a database link.

An example of such a statement is as follows:

```
CREATE TABLE tablename AS SELECT * FROM bar@dblink
```

This is because the *dblink* at the logical standby database may not point to the same database as the primary database. If SQL Apply fails while executing such a DDL statement, then use the DBMS\_LOGSTDBY.INSTANTIATE\_TABLE procedure for the table being created, and then restart SQL APPLY operations.



## C.14.2 Replication of AUD\$ and FGA\_LOG\$ on Logical Standbys

Auditing and fine-grained auditing are supported on logical standbys.

Changes made to the `AUD$` and `FGA_AUD$` tables at the primary database are replicated at the logical standby.

Both the `AUD$` table and the `FGA_AUD$` table have a `DBID` column. If the `DBID` value is that of the primary database, then the row was replicated to the logical standby based on activities at the primary. If the `DBID` value is that of the logical standby database, then the row was inserted as a result of local activities at the logical standby.

After the logical standby database assumes the primary role as a result of a role transition (either a switchover or failover), the `AUD$` and `FGA_AUD$` tables at the *new primary* (originally the logical standby) and at the *new logical standby* (originally the primary) are not necessarily synchronized. Therefore, it is possible that not all rows in the `AUD$` or `FGA_AUD$` tables at the new primary database will be present in the new logical standby database. However, all rows in `AUD$` and `FGA_LOG$` that were inserted while the database was in a primary role are replicated and present in the logical standby database.

## C.15 Distributed Transactions and XA Support

You can perform distributed transactions using a couple different methods.

- Modify tables in multiple databases in a coordinated manner using database links.
- Use the XA interface, as exposed by the `DBMS_XA` package in supplied PL/SQL packages or via OCI or JDBC libraries. The XA interface implements X/Open Distributed Transaction Processing (DTP) architecture.

Changes made to the primary database during a distributed transaction using either of these two methods are replicated to the logical standby database.

However, the distributed transaction state is not replicated. The logical standby database does not inherit the in-doubt or prepared state of such a transaction, and it does not replicate the changes using the same global transaction identifier used at the primary database for the XA transactions. As a result, if you fail over to a logical standby database before committing a distributed transaction, the changes are rolled back at the logical standby. This rollback occurs even if the distributed transaction on the primary database is in a prepared state and has successfully completed the first phase of the two-phased commit protocol. Switchover operations wait for all active distributed transactions to complete, and are not affected by this restriction.

XA transactions can be performed in two ways:

- tightly coupled, where different XA branches share locks
- loosely coupled, where different XA branches do not share locks

Replication of changes made by loosely coupled XA branches is supported regardless of the `COMPATIBLE` parameter value. Replication of changes made by tightly coupled branches on an Oracle RAC primary (introduced in 11g Release 1) is supported only with `COMPATIBLE=11.2` or higher.

## C.16 Support for SecureFiles LOBs

SecureFiles LOBs are supported when the database compatibility level is set to 11.2 or higher.

Transparent Data Encryption and data compression can be enabled on SecureFiles LOB columns at the primary database.

Deduplication of SecureFiles LOB columns and SecureFiles Database File System (DBFS) operations are fully supported.

If SQL Apply encounters redo generated by unsupported operations, it stops with an `ORA-16211: Unsupported record found in the archived redo log error`. To continue, add a skip rule for the affected table using `DBMS_LOGSTDBY.SKIP` and restart SQL Apply.

## C.17 Support for Database File System (DBFS)

The Database File System (DBFS) creates a standard file system interface on top of files and directories that are stored in database tables, which makes it easier for you to access and manage files stored in the database.

Logical standby supports the Database File System (DBFS). See *Oracle Database SecureFiles and Large Objects Developer's Guide* for more information about DBFS.

## C.18 Character Set Considerations

There are considerations to keep in mind regarding character sets.

- It is not supported to have a Data Guard configuration in which the primary database and logical standby database have different character sets.
- Configurations in which a multitenant container database (CDB) has a mixed character set are only supported when using `DBMS_ROLLING` for rolling upgrades. A mixed character set means that the `CDB$ROOT` and one or more of the CDB's pluggable databases (PDBs) have different character sets.

## C.19 Additional PL/SQL Package Support Available Only in the Context of `DBMS_ROLLING` Upgrades

Replication of certain packages is available only in the context of rolling upgrades performed using the `DBMS_ROLLING` package.

The affected packages are as follows:

- DBFS
  - `DBMS_DBFS_CONTENT_ADMIN`
  - `DBMS_DBFS_SFS`
  - `DBMS_DBFS_SFS_ADMIN`
- Lightweight Security

- XS\_ACL
- XS\_DATA\_SECURITY
- XS\_NAMESPACE
- XS\_PRINCIPAL
- XS\_ROLESET
- XS\_SECURITY\_CLASS
- Oracle Streams Advanced Queuing (AQ)
  - DBMS\_AQ
  - DBMS\_AQJMS
  - DBMS\_AQADM (except for the following procedures:  
SCHEDULE\_PROPAGATION, RECOVER\_PROPAGATION, UNSCHEDULE\_PROPAGATION,  
ALTER\_PROPAGATION\_SCHEDULE, ENABLE\_PROPAGATION\_SCHEDULE, and  
DISABLE\_PROPAGATION\_SCHEDULE)
- Oracle Text
  - CTX\_ADM
  - CTX\_ANL
  - CTX\_CLS
  - CTX\_DDL
  - CTX\_DOC
  - CTX\_ENTITY
  - CTX\_OUTPUT
  - CTX\_QUERY
  - CTX\_THES
  - CTX\_TREE
- Scheduler
  - DBMS\_SCHEDULER
- XDB-related
  - DBMS\_RESCONFIG
  - DBMS\_XDB\_CONFIG (Certain procedures are not supported. See *Oracle XML DB Developer's Guide* for more information.)
  - DBMS\_XDB\_REPOS
  - DBMS\_XDBRESOURCE
  - DBMS\_XDB\_VERSION
  - DBMS\_XDBZ (Certain procedures are not supported. See *Oracle XML DB Developer's Guide* for more information.)

 **See Also:**

- [Using DBMS\\_ROLLING to Perform a Rolling Upgrade](#)
- *Oracle Database Real Application Security Administrator's and Developer's Guide* for more information about the Lightweight Security packages
- *Oracle Database PL/SQL Packages and Types Reference* for more information about DBMS\_SCHEDULER, XDB-related, and DBFS-related packages

# D

## Oracle Data Guard and Oracle Real Application Clusters

An Oracle Data Guard configuration can consist of any combination of single-instance and Oracle Real Application Clusters (Oracle RAC) multiple-instance databases.

This appendix summarizes the configuration requirements and considerations that apply when using Oracle Data Guard with Oracle RAC databases. It contains the following sections:

- [Configuring Standby Databases in an Oracle RAC Environment](#)
- [Configuration Considerations in an Oracle RAC Environment](#)

### D.1 Configuring Standby Databases in an Oracle RAC Environment

You can configure a standby database to protect a primary database using Oracle Real Application Clusters (Oracle RAC).

The following table describes the possible combinations of instances in the primary and standby databases:

| Instance Combinations            | Single-Instance Standby Database | Multi-Instance Standby Database |
|----------------------------------|----------------------------------|---------------------------------|
| Single-instance primary database | Yes                              | Yes                             |
| Multi-instance primary database  | Yes                              | Yes                             |

In each scenario, each instance of the primary database transmits its redo data to an instance of the standby database. As of Oracle Database 12c release 2 (12.2.0.1) you can also perform multi-instance redo apply.

#### D.1.1 Setting Up Multi-Instance Redo Apply

As of Oracle Database 12c Release 2 (12.2.0.1), a new `INSTANCES [ ALL | integer ]` clause is available on the `SQL ALTER DATABASE RECOVER MANAGED STANDBY DATABASE` command.

To use In-Memory Column Store with multi-instance redo apply in an Active Data Guard environment, set the `enable_imc_with_mira` initialization parameter to `TRUE`.

The following restrictions apply:

- The clause is applicable only for Oracle Real Application Clusters (Oracle RAC) or Oracle RAC One Node databases.

- You cannot use multi-instance redo apply when you enable `STANDBY NOLOGGING FOR DATA AVAILABILITY` or `STANDBY NOLOGGING FOR LOAD PERFORMANCE` on the primary database.

The `ALL` option causes redo apply to run on all instances in an Oracle RAC standby database that are in an open or mounted state at the time recovery is started. All instances must be in the same state — either open or mounted. A mix of states is not allowed.

The `integer` option restricts the number of instances that redo apply uses to the number you specify. For `integer`, specify an integer value from 1 to the number of instances in the standby database. The database chooses the instances on which to perform Redo Apply; you cannot specify particular instances.

The `V$RECOVERY_PROGRESS` view is only populated on the instance where recovery was started (where the `MRPO` process resides).

If you omit the `INSTANCES` clause, then recovery happens on only one instance where the command was issued.

Because recovery processes ship redo among instances, redo apply performance is directly related to network bandwidth and latency.

## D.1.2 Setting Up a Multi-Instance Primary with a Single-Instance Standby

This figure illustrates an Oracle RAC database with two primary database instances (a multi-instance primary database) transmitting redo data to a single-instance standby database.

**Figure D-1 Transmitting Redo Data from a Multi-Instance Primary Database**

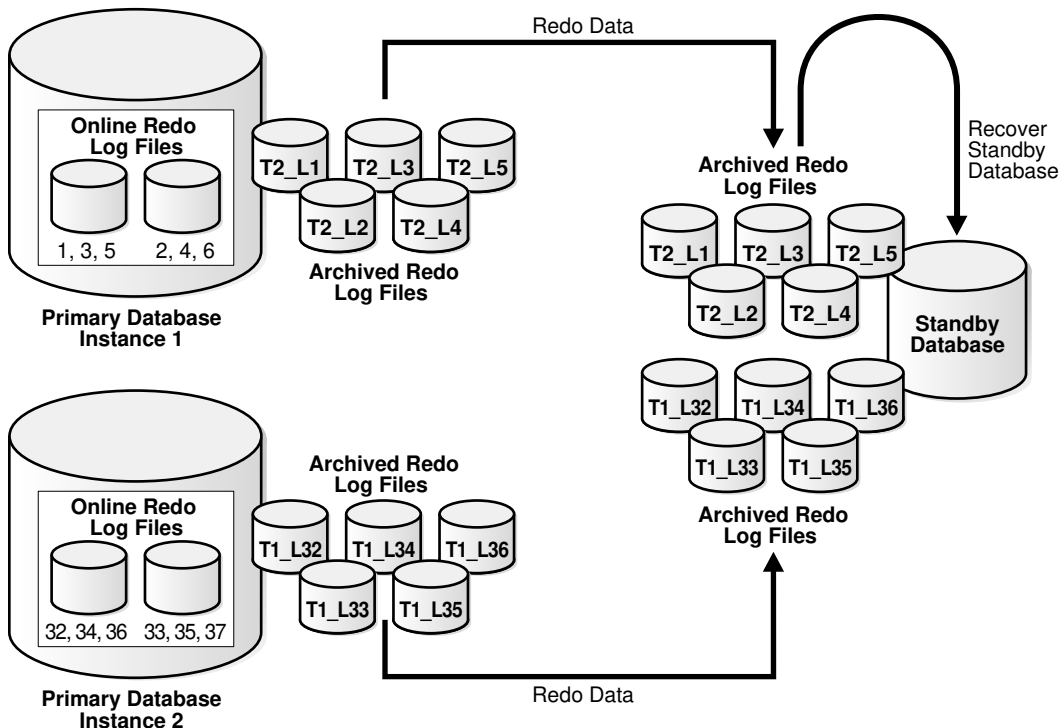

In this case, Instance 1 of the primary database archives redo data to local archived redo log files 1, 2, 3, 4, 5 and transmits the redo data to the standby database destination, while Instance 2 archives redo data to local archived redo log files 32, 33, 34, 35, 36 and transmits the redo data to the same standby database destination. The standby database automatically determines the correct order in which to apply the archived redo log files.

Although [Figure D-1](#) does not show standby redo logs, it is a best practice to configure standby redo logs at the standby for both instances of the primary. The redo from the primary online redo log files at Instance 1 and Instance 2 would then be received first in the standby redo logs for Instance 1 and Instance 2, respectively, and then archived.

### To Configure a Primary Database in an Oracle RAC Environment

Before you create a standby database you must first ensure the primary database is properly configured. To do so, you must perform some preparatory steps, after which the database is prepared to serve as the primary database for one or more standby databases.

### To Configure a Single Instance Standby Database

To specify the location of the archived redo log files and standby redo log files, define the `LOG_ARCHIVE_DEST_n` and `LOG_ARCHIVE_FORMAT` parameters.

#### See Also:

- [Managing Standby Redo Logs](#) for more information about standby redo logs
- [Creating a Physical Standby Database](#) for information about configuring a primary database when creating a physical standby database.
- [Creating a Logical Standby Database](#) for information about configuring a primary database when creating a logical standby database.

## D.1.3 Setting Up Oracle RAC Primary and Standby Databases

An Oracle RAC primary database must be set up to send redo data to an Oracle RAC standby database, and an Oracle RAC standby database must be set up to receive redo data.

### D.1.3.1 Configuring an Oracle RAC Standby Database to Receive Redo Data

These steps describe how to configure an Oracle RAC standby database to receive redo data from a primary database.

1. Create a standby redo log on the standby database. The redo log files in the standby redo log must reside in a location that can be accessed by all of the standby database instances, such as on a cluster file system or Oracle ASM instance. See [Managing Standby Redo Logs](#) for more information about creating a standby redo log.
2. Configure standby redo log archival on each standby database instance. The standby redo log must be archived to a location that can be accessed by all of

the standby database instances, and every standby database instance must be configured to archive the standby redo log to the same location.

### D.1.3.2 Configuring an Oracle RAC Primary Database to Send Redo Data

Configure each instance of the Oracle RAC primary database to send its redo data to the Oracle RAC standby database. These are the best practices that Oracle recommends you follow when you configure an Oracle RAC primary database to send redo data to an Oracle RAC standby database.

1. Use the same `LOG_ARCHIVE_DEST_n` parameter on each primary database instance to send redo data to a given standby database.
2. Set the `SERVICE` attribute of each `LOG_ARCHIVE_DEST_n` parameter that corresponds to a given standby database to the same net service name.
3. The net service name should resolve to an Oracle Net connect descriptor that contains an address list, and that address list should contain connection data for each standby database instance.

[Configuring an Oracle Database to Send Redo Data](#) describes how to configure an Oracle database instance to send redo data to another database.

## D.2 Configuration Considerations in an Oracle RAC Environment

Oracle Real Application Clusters (Oracle RAC) have specific Oracle Data Guard configuration requirements regarding the format for archived redo log filenames, and for data protection modes.

See the following topics:

- [Format for Archived Redo Log Filenames](#)
- [Data Protection Modes](#)

### D.2.1 Format for Archived Redo Log Filenames

The format for archived redo log filenames is in the form of `log_%parameter`.

The `%parameter` can include one or more of the parameters in [Table D-1](#).

**Table D-1 Directives for the LOG\_ARCHIVE\_FORMAT Initialization Parameter**

| Directives | Description                          |
|------------|--------------------------------------|
| %a         | Database activation ID.              |
| %A         | Database activation ID, zero filled. |
| %d         | Database ID.                         |
| %D         | Database ID, zero filled.            |
| %t         | Instance thread number.              |
| %T         | Instance thread number, zero filled. |
| %s         | Log file sequence number.            |



**Table D-1 (Cont.) Directives for the LOG\_ARCHIVE\_FORMAT Initialization Parameter**

| Directives | Description                            |
|------------|----------------------------------------|
| %S         | Log file sequence number, zero filled. |
| %r         | Resetlogs ID.                          |
| %R         | Resetlogs ID, zero filled.             |

For example:

```
LOG_ARCHIVE_FORMAT = log%d_%t_%s_%r.arc
```

The thread parameters %t or %T are mandatory for Oracle RAC to uniquely identify the archived redo log files with the LOG\_ARCHIVE\_FORMAT parameter.

## D.2.2 Data Protection Modes

If any instance of an Oracle RAC primary database loses connectivity with a standby database, all other primary database instances stop sending redo to the standby database for the number of seconds specified on the LOG\_ARCHIVE\_DEST\_n REOPEN attribute, after which all primary database instances attempt to reconnect to the standby database.

The following list describes the behavior of the protection modes in Oracle RAC environments:

- **Maximum protection configuration**  
If a lost destination is the *last* participating SYNC destination, then the instance loses connectivity and is shut down. Other instances in an Oracle RAC configuration that still have connectivity to the standby destinations recover the lost instance and continue sending redo to their standby destinations. Only when every instance in an Oracle RAC configuration loses connectivity to the last standby destination is the primary database shut down.
- **Maximum availability and maximum performance configurations**  
Other instances in an Oracle RAC configuration that still have connectivity to the standby destination recover the lost instance and continue sending redo to their standby destinations. When every instance in an Oracle RAC configuration loses connectivity to the standby destination, the primary database continues operation in maximum performance mode. The maximum performance mode ensures very minimal data loss except when the entire standby fails.

The maximum availability protection mode ensures zero data loss except in the case of certain double faults, such as failure of the primary database after the failure of all standby databases.

# E

## Creating a Standby Database with Recovery Manager

These topics describe how to use Oracle Recovery Manager to create a standby database.

- [Prerequisites](#)
- [Overview of Standby Database Creation with RMAN](#)
- [Using the DUPLICATE Command to Create a Standby Database](#)

### E.1 Prerequisites

Before you create a standby database with RMAN, you should be familiar with database duplication.

Because you use the `DUPLICATE` command to create a standby database with RMAN, you should also familiarize yourself with the `DUPLICATE` command .

Also familiarize yourself with how to create a standby database *before* you attempt to create a standby database with RMAN.

#### See Also:

- *Oracle Database Backup and Recovery User's Guide* for information about database duplication
- *Oracle Database Backup and Recovery Reference* for a description of the RMAN `DUPLICATE` command
- [Creating a Physical Standby Database](#)
- [Creating a Logical Standby Database](#)

### E.2 Overview of Standby Database Creation with RMAN

Read this section for information about the purpose and basic concepts involved in standby database creation with RMAN.

#### E.2.1 Purpose of Standby Database Creation with RMAN

You can use either manual techniques or the RMAN `DUPLICATE` command to create a standby database from backups of your primary database.

You can use either manual techniques or the RMAN `DUPLICATE` command to create a standby database from backups of your primary database. Creating a standby database with RMAN has the following advantages over manual techniques:

- RMAN can create a standby database by copying the files currently in use by the primary database. No backups are required.
- RMAN can create a standby database by restoring backups of the primary database to the standby site. Thus, the primary database is not affected during the creation of the standby database.
- RMAN automates renaming of files, including Oracle Managed Files (OMF) and directory structures.
- RMAN restores archived redo log files from backups and performs media recovery so that the standby and primary databases are synchronized.

## E.2.2 Basic Concepts of Standby Creation with RMAN

The procedure for creating a standby database with RMAN is almost the same as for creating a duplicate database.

You need to amend the duplication procedures described in *Oracle Database Backup and Recovery User's Guide* to account for issues specific to a standby database.

To create a standby database with the `DUPLICATE` command you must connect as target to the primary database and specify the `FOR STANDBY` option. You cannot connect to a standby database and create an additional standby database. RMAN creates the standby database by restoring and mounting a control file. RMAN can use an existing backup of the primary database control file, so you do not need to create a control file backup especially for the standby database.

A standby database, unlike a duplicate database created by `DUPLICATE` *without* the `FOR STANDBY OPTION`, does not get a new DBID. Therefore, do not register the standby database with your recovery catalog.

### E.2.2.1 Active Database and Backup-Based Duplication

When you are using RMAN to create a standby, you must choose between active and backup-based duplication.

If you specify `FROM ACTIVE DATABASE`, then RMAN copies the data files directly from the primary database to the standby database. The primary database must be mounted or open.

If you not specify `FROM ACTIVE DATABASE`, then RMAN performs backup-based duplication. RMAN restores backups of the primary data files to the standby database. All backups and archived redo log files needed for creating and recovering the standby database must be accessible by the server session on the standby host. RMAN restores the most recent data files unless you execute the `SET UNTIL` command.

### E.2.2.2 DB\_UNIQUE\_NAME Values in an RMAN Environment

A standby database, unlike a duplicate database created by `DUPLICATE` *without* the `FOR STANDBY` option, does not get a new DBID.

When you use RMAN in an Oracle Data Guard environment, connect it to a recovery catalog. The recovery catalog can store the metadata for all primary and standby

databases in the environment. Do not explicitly register the standby database in the recovery catalog.

A database in an Oracle Data Guard environment is uniquely identified by means of the `DB_UNIQUE_NAME` parameter in the initialization parameter file. The `DB_UNIQUE_NAME` must be unique across all the databases with the same DBID for RMAN to work correctly in an Oracle Data Guard environment.

 **See Also:**

*Oracle Database Backup and Recovery User's Guide* for a conceptual overview of RMAN operation in an Oracle Data Guard environment

### E.2.2.3 Recovery of a Standby Database

By default, RMAN does not recover the standby database after creating it.

RMAN leaves the standby database mounted, but does not place the standby database in manual or managed recovery mode. RMAN disconnects and does not perform media recovery of the standby database.

For RMAN to recover the standby database after creating it, the standby control file must be usable for the recovery. The following conditions must be met:

- The end recovery time of the standby database must be greater than or equal to the checkpoint SCN of the standby control file.
- An archived redo log file containing the checkpoint SCN of the standby control file must be available at the standby site for recovery.

One way to ensure these conditions are met is to issue the `ALTER SYSTEM ARCHIVE LOG CURRENT` statement after backing up the control file on the primary database. This statement archives the online redo log files of the primary database. Then, either back up the most recent archived redo log file with RMAN or move the archived redo log file to the standby site.

Use the `DORECOVER` option of the `DUPLICATE` command to specify that you want RMAN to recover the standby database. RMAN performs the following steps after creating the standby database files:

1. RMAN begins media recovery. If recovery requires archived redo log files, and if the log files are not already on disk, then RMAN attempts to restore backups.
2. RMAN recovers the standby database to the specified time, system change number (SCN), or log file sequence number, or to the latest archived redo log file generated if none of the preceding are specified.
3. RMAN leaves the standby database mounted after media recovery is complete, but does *not* place the standby database in manual or managed recovery mode.

#### E.2.2.3.1 Standby Database Redo Log Files

RMAN automatically creates the standby redo log files on the standby database.

After the log files are created, the standby database maintains and archives them according to the normal rules for log files.

If you use backup-based duplication, then the only option when naming the standby redo log files on the standby database is the file names for the log files, as specified in the standby control file. If the log file names on the standby must be different from the primary file names, then one option is to specify file names for the standby redo logs by setting `LOG_FILE_NAME_CONVERT` in the standby initialization parameter file.

Note the following restrictions when specifying file names for the standby redo log files on the standby database:

- You must use the `LOG_FILE_NAME_CONVERT` parameter to name the standby redo log files if the primary and standby databases use different naming conventions for the log files.
- You cannot use the `SET NEWNAME` or `CONFIGURE AUXNAME` commands to rename the standby redo log files.
- You cannot use the `LOGFILE` clause of the `DUPLICATE` command to specify file names for the standby redo log files.
- For the standby redo log file names on the standby database to be the same as the primary redo log file names, you must specify the `NOFILENAMECHECK` clause of the `DUPLICATE` command. Otherwise, RMAN signals an error even if the standby database is created on a different host.

#### E.2.2.4 Password Files for the Standby Database

If you are using active database duplication, then RMAN always copies the password file to the standby host because the password file on the standby database must be an exact copy of the password file on the target database.

If you are using active database duplication, then RMAN always copies the password file to the standby host because the password file on the standby database must be an exact copy of the password file on the target database. In this case, the `PASSWORD FILE` clause is not necessary. RMAN overwrites any existing password file for the auxiliary instance. With backup-based duplication you must copy the password file used on the primary to the standby, for Oracle Data Guard to ship logs.

## E.3 Using the DUPLICATE Command to Create a Standby Database

The procedure for creating a standby database is basically identical to the RMAN duplication procedure.

See *Oracle Database Backup and Recovery User's Guide* for information about the RMAN duplication procedure.

## E.3.1 Using Active Database Duplication to Create a Standby Database or Far Sync Instance

You can use active database duplication to create either a standby database or a far sync instance.

### Creating a Standby Database with Active Database Duplication

To use the RMAN `DUPLICATE` command to create a standby database from files that are active in the primary database, you must specify both the `FOR STANDBY` and `FROM ACTIVE DATABASE` options. You can specify other options as well, such as `DORECOVER`. For example:

```
DUPLICATE TARGET DATABASE FOR STANDBY FROM ACTIVE DATABASE DORECOVER;
```

### Creating a Far Sync Instance with Active Database Duplication

As of Oracle Database 12c Release 12.2 (12.2.0.1), you can also use the RMAN `DUPLICATE` command to create a far sync instance from files that are active in the primary database. To do so, substitute `FARSYNC` in place of `STANDBY` on the command line (do not specify the `DORECOVER` option; it is not allowed for far sync instances). For example:

```
DUPLICATE TARGET DATABASE FOR FARSYNC FROM ACTIVE DATABASE;
```

### Steps to Create a Standby Database or Far Sync Instance Using Active Database Duplication

The following steps create a standby database from active database files, but you could also use these steps to create a far sync instance from active database files. The steps assume that the standby host (or far sync instance), and primary database host have the same directory structure.

1. Prepare the auxiliary database instance as explained in *Oracle Database Backup and Recovery User's Guide*.

Because you are using active database duplication, you must create a password file for the auxiliary instance and establish Oracle Net connectivity. This is a temporary password file which is overwritten during the duplicate operation.

2. Decide how to provide names for the standby control files, data files, online redo logs, and tempfiles. This step is explained in *Oracle Database Backup and Recovery User's Guide*.

In this scenario, the standby database files are named the same as the primary database files.

3. Start and configure RMAN as explained in *Oracle Database Backup and Recovery User's Guide*.
4. Execute the `DUPLICATE` command.

The following example illustrates how to use `DUPLICATE` for active duplication. This example requires the `NOFILENAMECHECK` option because the primary database files have the same names as the standby database files. The `SET` clauses for

SPFILE are required for log shipping to work properly. The `db_unique_name` must be set to ensure that the catalog and Oracle Data Guard can identify this database as being different from the primary. Optionally, specify the `DORECOVER` option to recover the database after standby creation (`DORECOVER` is not a valid option for far sync instances).

```

DUPLICATE TARGET DATABASE
  FOR STANDBY
  FROM ACTIVE DATABASE
  DORECOVER
  SPFILE
  SET "db_unique_name"="foou" COMMENT "Is a duplicate"
  SET LOG_ARCHIVE_DEST_2="service=inst3 ASYNC REGISTER
    VALID_FOR=(online_logfile,primary_role)"
  SET FAL_SERVER="inst1" COMMENT "Is primary"
NOFILENAMECHECK;

```

RMAN automatically copies the server parameter file to the standby host, starts the auxiliary instance with the server parameter file, restores a backup control file, and copies all necessary database files and archived redo logs over the network to the standby host. RMAN recovers the standby database, but does not place it in manual or managed recovery mode.

If you were creating a far sync instance rather than a standby, the command would be the same except that `STANDBY` is replaced with `FARSYNC`, as follows:

```

DUPLICATE TARGET DATABASE
  FOR FARSYNC
  FROM ACTIVE DATABASE
  SPFILE
  SET "db_unique_name"="foou" COMMENT "Is a duplicate"
  SET LOG_ARCHIVE_DEST_2="service=inst3 ASYNC REGISTER
    VALID_FOR=(online_logfile,primary_role)"
  SET FAL_SERVER="inst1" COMMENT "Is primary"
NOFILENAMECHECK;

```

 **Note:**

If the primary is an Oracle Real Application Clusters (Oracle RAC) database, and the target standby database or far sync instance is going to be a single-instance Oracle database, then add the command `SET CLUSTER_DATABASE="FALSE"` to the previous RMAN examples.

## E.3.2 Creating a Standby Database with Backup-Based Duplication

You can use backup—based duplication to create either a standby database or a far sync instance.

### Creating a Standby Database with Backup-Based Duplication

To create a standby database from backups, specify `FOR STANDBY` but do not specify `FROM ACTIVE DATABASE`. You can specify other options as well, such as `DORECOVER`. For example:

```
DUPLICATE TARGET DATABASE FOR STANDBY BACKUP LOCATION '+DATA/BACKUP'  
DORECOVER;
```

### Creating a Far Sync Instance with Backup-Based Duplication

As of Oracle Database 12c Release 12.2 (12.2.0.1), you can also use backup-based duplication to create a Data Guard far sync instance using the `RMAN DUPLICATE` command. To do so, substitute `FARSYNC` in place of `STANDBY` on the command line (do not specify the `DORECOVER` option; it is not allowed for far sync instances). For example:

```
DUPLICATE TARGET DATABASE FOR FARSYNC BACKUP LOCATION '+DATA/BACKUP';
```

### Steps to Create a Standby Database or Far Sync Instance from Backups:

The following steps create a standby database from backup files, but you could also use these steps to create a far sync instance from backup files. The steps assume that the standby host (or far sync instance), and primary database host have the same directory structure.

1. Make database backups and archived redo logs available to the auxiliary instance on the duplicate host as explained in *Oracle Database Backup and Recovery User's Guide*.
2. Prepare the auxiliary database instance as explained in *Oracle Database Backup and Recovery User's Guide*.
3. Decide how to provide names for the standby control files, data files, online redo logs, and tempfiles. This step is explained in *Oracle Database Backup and Recovery User's Guide*.

In this scenario, the standby database files are named the same as the primary database files.

4. Start and configure RMAN as explained in *Oracle Database Backup and Recovery User's Guide*.
5. Execute the `DUPLICATE` command.

The following example illustrates how to use `DUPLICATE` for backup-based duplication. This example requires the `NOFILENAMECHECK` option because the primary database files have the same names as the standby database files.



Optionally, specify the `DORECOVER` option to recover the database after standby creation (`DORECOVER` is not a valid option for far sync instances).

```
DUPLICATE TARGET DATABASE
FOR STANDBY
DORECOVER
SPFILE
  SET "db_unique_name"="foou" COMMENT "Is a duplicate"
  SET LOG_ARCHIVE_DEST_2="service=inst3 ASYNC REGISTER
  VALID_FOR=(online_logfile,primary_role)"
  SET FAL_SERVER="inst1" COMMENT "Is primary"
NOFILENAMECHECK;
```

RMAN automatically copies the server parameter file to the standby host, starts the auxiliary instance with the server parameter file, and restores all necessary database files and archived redo logs to the standby host. RMAN recovers the standby database, but does not place it in manual or managed recovery mode.

# F

## Setting Archive Tracing

The Oracle database uses the `LOG_ARCHIVE_TRACE` initialization parameter to enable and control the generation of comprehensive trace information for log archiving and redo transport activity.

The additional tracing that is output when `LOG_ARCHIVE_TRACE` is set to a nonzero value can appear in trace files for an archive process, RFS process, LGWR process, SYNC process, ASYNC process, foreground process, MRP process, recovery process, log apply process, startup process, shutdown process, and other processes that use redo transport services. Tracing information is written to the Automatic Diagnostic Repository.

### See Also:

- *Oracle Database Reference* for a complete description of the `LOG_ARCHIVE_TRACE` initialization parameter and its valid values
- *Oracle Database Administrator's Guide* for more information about the Automatic Diagnostic Repository

## F.1 Setting the `LOG_ARCHIVE_TRACE` Initialization Parameter

To enable, disable, or modify the `LOG_ARCHIVE_TRACE` parameter, you issue an `ALTER SYSTEM` SQL statement.

The format for the `LOG_ARCHIVE_TRACE` parameter is as follows, where *trace\_level* is an integer:

```
LOG_ARCHIVE_TRACE=trace_level
```

The following is an example of setting the `LOG_ARCHIVE_TRACE` parameter:

```
SQL> ALTER SYSTEM SET LOG_ARCHIVE_TRACE=15;
```

You can combine tracing levels by setting the value of the `LOG_ARCHIVE_TRACE` parameter to the sum of the individual levels. For instance, in the previous example, setting the `LOG_ARCHIVE_TRACE` parameter to a value of 15 sets trace levels 1, 2, 4, and 8.

For a complete list and description of valid `LOG_ARCHIVE_TRACE` values, see *Oracle Database Reference*.

The following are examples of the ARC0 trace data generated on the primary site by the archiving of log file 387 to two different destinations: the service `standby1` and the local directory `/oracle/dbs`.



**Note:**

The level numbers do not appear in the actual trace output; they are shown here for clarification only.

```

Level   Corresponding entry content (sample)
-----
( 1)    ARC0: Begin archiving log# 1 seq# 387 thrd# 1
( 4)    ARC0: VALIDATE
( 4)    ARC0: PREPARE
( 4)    ARC0: INITIALIZE
( 4)    ARC0: SPOOL
( 8)    ARC0: Creating archive destination 2 : 'standby1'
(16)    ARC0: Issuing standby Create archive destination at 'standby1'
( 8)    ARC0: Creating archive destination 1 : '/oracle/dbs/dlarcl_387.log'
(16)    ARC0: Archiving block 1 count 1 to : 'standby1'
(16)    ARC0: Issuing standby Archive of block 1 count 1 to 'standby1'
(16)    ARC0: Archiving block 1 count 1 to : '/oracle/dbs/dlarcl_387.log'
( 8)    ARC0: Closing archive destination 2 : standby1
(16)    ARC0: Issuing standby Close archive destination at 'standby1'
( 8)    ARC0: Closing archive destination 1 : /oracle/dbs/dlarcl_387.log
( 4)    ARC0: FINISH
( 2)    ARC0: Archival success destination 2 : 'standby1'
( 2)    ARC0: Archival success destination 1 : '/oracle/dbs/dlarcl_387.log'
( 4)    ARC0: COMPLETE, all destinations archived
(16)    ARC0: ArchivedLog entry added: /oracle/dbs/dlarcl_387.log
(16)    ARC0: ArchivedLog entry added: standby1
( 4)    ARC0: ARCHIVED
( 1)    ARC0: Completed archiving log# 1 seq# 387 thrd# 1

(32)   Propagating archive 0 destination version 0 to version 2
        Propagating archive 0 state version 0 to version 2
        Propagating archive 1 destination version 0 to version 2
        Propagating archive 1 state version 0 to version 2
        Propagating archive 2 destination version 0 to version 1
        Propagating archive 2 state version 0 to version 1
        Propagating archive 3 destination version 0 to version 1
        Propagating archive 3 state version 0 to version 1
        Propagating archive 4 destination version 0 to version 1
        Propagating archive 4 state version 0 to version 1

(64)   ARCH: changing ARC0 KCRNOARCH->KCRRSCHED
        ARCH: STARTING ARCH PROCESSES
        ARCH: changing ARC0 KCRRSCHED->KCRRSTART
        ARCH: invoking ARC0
        ARC0: changing ARC0 KCRRSTART->KCRRACTIVE
        ARCH: Initializing ARC0
        ARCH: ARC0 invoked
        ARCH: STARTING ARCH PROCESSES COMPLETE
        ARC0 started with pid=8
        ARC0: Archival started
    
```

The following is the trace data generated by the remote file server (RFS) process on the standby site as it receives archived redo log file 387 in directory /stby and applies it to the standby database:

```

level   trace output (sample)
-----
    
```

```
( 4) RFS: Startup received from ARCH pid 9272
( 4) RFS: Notifier
( 4) RFS: Attaching to standby instance
( 1) RFS: Begin archive log# 2 seq# 387 thrd# 1
(32) Propagating archive 5 destination version 0 to version 2
(32) Propagating archive 5 state version 0 to version 1
( 8) RFS: Creating archive destination file: /stby/parcl_387.log
(16) RFS: Archiving block 1 count 11
( 1) RFS: Completed archive log# 2 seq# 387 thrd# 1
( 8) RFS: Closing archive destination file: /stby/parcl_387.log
(16) RFS: ArchivedLog entry added: /stby/parcl_387.log
( 1) RFS: Archivelog seq# 387 thrd# 1 available 04/02/99 09:40:53
( 4) RFS: Detaching from standby instance
( 4) RFS: Shutdown received from ARCH pid 9272
```

# G

## Performing Role Transitions Using Old Syntax

Prior to Oracle Database 12c Release 1 (12.1), the procedures for performing switchovers and failovers to a physical standby database were different.

These procedures are still supported, but Oracle recommends you use the new procedures described in "[Role Transitions Involving Physical Standby Databases](#)".

If you are using a release prior to Oracle Database 12c Release 1 (12.1), then you must use the old procedures.

The following topics are discussed:

- [SQL Syntax for Role Transitions Involving Physical Standbys](#)
- [Role Transitions Involving Physical Standby Databases](#)
- [Troubleshooting Switchovers to Physical Standby Databases](#)

### G.1 SQL Syntax for Role Transitions Involving Physical Standbys

Oracle Database 12c Release 1 (12.1) introduces new SQL syntax for performing switchover and failover operations to a physical standby database.

Oracle Database 12c Release 1 (12.1) introduces new SQL syntax for performing switchover and failover operations to a physical standby database. Do not mix syntax from the old procedures (described in this topic) and the new procedures (described in [Role Transitions](#)), unless you are specifically directed to do so.

---

**Pre-12c Role Transition Syntax for Physical Standby Databases**

To switchover to a physical standby database, on the primary database:

```
SQL> ALTER DATABASE COMMIT TO SWITCHOVER TO PHYSICAL STANDBY;
```

On the physical standby database:

```
SQL> ALTER DATABASE COMMIT TO SWITCHOVER TO PRIMARY;
```

---

**12c Role Transition Syntax for Physical Standby Databases**

To switchover to a physical standby database:

```
SQL> ALTER DATABASE SWITCHOVER TO target_db_name [FORCE] [VERIFY];
```

| Pre-12c Role Transition Syntax for Physical Standby Databases                                                                                                                                                                                                                                                               | 12c Role Transition Syntax for Physical Standby Databases                                                                                                                                 |
|-----------------------------------------------------------------------------------------------------------------------------------------------------------------------------------------------------------------------------------------------------------------------------------------------------------------------------|-------------------------------------------------------------------------------------------------------------------------------------------------------------------------------------------|
| <p>To failover to a physical standby database, (step 6 and step 8 in "<a href="#">Performing a Failover to a Physical Standby Database Using Old Syntax</a>"):</p> <pre>SQL&gt; ALTER DATABASE RECOVER MANAGED STANDBY DATABASE FINISH;</pre> <p>and</p> <pre>SQL&gt; ALTER DATABASE COMMIT TO SWITCHOVER TO PRIMARY;</pre> | <p>To failover to a physical standby database, the following statement replaces the two statements previously required:</p> <pre>SQL&gt; ALTER DATABASE FAILOVER TO target_db_name;</pre> |

 **See Also:**

- [Oracle Database SQL Language Reference](#) for more information about SQL syntax

## G.1.1 New Features When Using the Old Syntax

As of Oracle Database 12c Release 1 (12.1), the `WITH SESSION SHUTDOWN` clause is no longer needed to terminate active SQL sessions.

You can issue the following statement to automatically terminate active SQL sessions:

```
SQL> ALTER DATABASE COMMIT TO SWITCHOVER TO PHYSICAL STANDBY;
```

Additionally, when you perform a switchover from an Oracle RAC primary database to a physical standby database, it is no longer necessary to shut down all but one primary database instance. All the instances are shut down automatically after the switchover is complete.

## G.2 Role Transitions Involving Physical Standby Databases

The SQL syntax to perform switchovers and failovers to a physical standby database was different in releases prior to Oracle Database 12c Release 1 (12.1).

The following are the procedures that must be used if you are running a release prior to 12.1:

- [Performing a Switchover to a Physical Standby Database Using Old Syntax](#)
- [Performing a Failover to a Physical Standby Database Using Old Syntax](#)

 **See Also:**

[Role Transitions](#) for information about how to prepare for switchovers and failovers

## G.2.1 Performing a Switchover to a Physical Standby Database Using Old Syntax

A switchover is initiated on the primary database and is completed on the target standby database.

This topic describes how to perform a switchover to a physical standby database.

1. Verify that the primary database can be switched to the standby role.

Query the `SWITCHOVER_STATUS` column of the `V$DATABASE` view on the primary database. For example:

```
SQL> SELECT SWITCHOVER_STATUS FROM V$DATABASE;

SWITCHOVER_STATUS
-----
TO STANDBY
1 row selected
```

A value of `TO STANDBY` or `SESSIONS ACTIVE` indicates that the primary database can be switched to the standby role. If neither of these values is returned, a switchover is not possible because redo transport is either misconfigured or is not functioning properly. See [Redo Transport Services](#) for information about configuring and monitoring redo transport.

2. Issue the following SQL statement on the primary database to switch it to the standby role: Issue the following SQL statement on the primary database to switch it to the standby role:

```
SQL> ALTER DATABASE COMMIT TO SWITCHOVER TO PHYSICAL STANDBY;
```

This statement converts the primary database into a physical standby database. The current control file is backed up to the current SQL session trace file before the switchover. This makes it possible to reconstruct a current control file, if necessary.

3. Mount the former primary database. For example: For example:

```
SQL> STARTUP MOUNT;
```

At this point in the switchover process, the original primary database is a physical standby database.

4. Query the `SWITCHOVER_STATUS` column of the `V$DATABASE` view on the standby database to verify that the switchover target is ready to be switched to the primary role. For example:

```
SQL> SELECT SWITCHOVER_STATUS FROM V$DATABASE;

SWITCHOVER_STATUS
-----
TO PRIMARY
1 row selected
```

A value of `TO PRIMARY` or `SESSIONS ACTIVE` indicates that the standby database is ready to be switched to the primary role. If neither of these values is returned, verify that Redo Apply is active and that redo transport is configured and working

properly. Continue to query this column until the value returned is either TO PRIMARY or SESSIONS ACTIVE.

5. Issue the following SQL statement on the target physical standby database to switch it to the primary role:

```
SQL> ALTER DATABASE COMMIT TO SWITCHOVER TO PRIMARY WITH SESSION SHUTDOWN;
```

 **Note:**

The WITH SESSION SHUTDOWN clause can be omitted from the switchover statement if the query performed in step 4 returned a value of TO PRIMARY.

6. Open the new primary database:

```
SQL> ALTER DATABASE OPEN;
```

7. Start Redo Apply on the new physical standby database:

```
SQL> ALTER DATABASE RECOVER MANAGED STANDBY DATABASE -  
> DISCONNECT FROM SESSION;
```

8. Restart Redo Apply if it has stopped at any of the other physical standby databases in your Oracle Data Guard configuration:

```
SQL> ALTER DATABASE RECOVER MANAGED STANDBY DATABASE -  
> DISCONNECT FROM SESSION;
```

## G.2.2 Performing a Failover to a Physical Standby Database Using Old Syntax

These steps describe how to perform a failover to a physical standby database.

1. If possible, mount the primary database and flush any unsent archived and current redo from the primary database to the standby database. If this operation is successful, a zero data loss failover is possible even if the primary database is not in a zero data loss data protection mode.

Ensure that Redo Apply is active at the target standby database.

Mount, but do not open, the primary database. If the primary database cannot be mounted, go to step 2.

Issue the following SQL statement at the primary database:

```
SQL> ALTER SYSTEM FLUSH REDO TO target_db_name;
```

For *target\_db\_name*, specify the DB\_UNIQUE\_NAME of the standby database that is to receive the redo flushed from the primary database.

This statement flushes any unsent redo from the primary database to the standby database, and waits for that redo to be applied to the standby database.

If this statement completes without any errors, go to step 5. If the statement completes with any errors, or if it must be stopped because you cannot wait any longer for the statement to complete, continue with step 2.



2. Verify that the standby database has the most recently archived redo log file for each primary database redo thread.

To do this, query the V\$ARCHIVED\_LOG view on the target standby database to obtain the highest log sequence number for each redo thread.

For example:

```
SQL> SELECT UNIQUE THREAD# AS THREAD, MAX(SEQUENCE#) -
> OVER (PARTITION BY thread#) AS LAST from V$ARCHIVED_LOG;
```

| THREAD | LAST  |
|--------|-------|
| -----  | ----- |
| 1      | 100   |

If possible, copy the most recently archived redo log file for each primary database redo thread to the standby database if it does not exist there, and register it. This must be done for each redo thread.

For example:

```
SQL> ALTER DATABASE REGISTER PHYSICAL LOGFILE 'filespec1';
```

3. Query the V\$ARCHIVE\_GAP view on the target standby database to determine if there are any redo gaps on the target standby database.

For example:

```
SQL> SELECT THREAD#, LOW_SEQUENCE#, HIGH_SEQUENCE# FROM V$ARCHIVE_GAP;
```

| THREAD# | LOW_SEQUENCE# | HIGH_SEQUENCE# |
|---------|---------------|----------------|
| -----   | -----         | -----          |
| 1       | 90            | 92             |

In this example, the gap comprises archived redo log files with sequence numbers 90, 91, and 92 for thread 1.

If possible, copy any missing archived redo log files to the target standby database from the primary database and register them at the target standby database. This must be done for each redo thread.

For example:

```
SQL> ALTER DATABASE REGISTER PHYSICAL LOGFILE 'filespec1';
```

4. Repeat step 3 until all gaps are resolved. (The query executed in step 3 displays information for the highest gap only, so after resolving a gap, you must repeat the query until no more rows are returned.)

If, after performing steps 2 through step 4, you are not able to resolve all gaps in the archived redo log files (for example, because you do not have access to the system that hosted the failed primary database), then some data loss will occur during the failover.

5. Issue the following SQL statement on the target standby database to stop Redo Apply:

```
SQL> ALTER DATABASE RECOVER MANAGED STANDBY DATABASE CANCEL;
```

6. Finish applying all received redo data:

```
SQL> ALTER DATABASE RECOVER MANAGED STANDBY DATABASE FINISH;
```

If this statement completes without any errors, then proceed to step 7.

If an error occurs, some received redo data was not applied. Try to resolve the cause of the error and reissue the statement before proceeding to the next step.

If there is a redo gap that was not resolved in step 3 and step 4, then you receive an error stating that there is a redo gap.

If the error condition cannot be resolved, a failover can still be performed (with some data loss) by issuing the following SQL statement on the target standby database:

```
SQL> ALTER DATABASE ACTIVATE PHYSICAL STANDBY DATABASE;
```

Proceed to step 9 when the `ACTIVATE` statement completes.

7. Verify that the target standby database is ready to become a primary database.

To do this, query the `SWITCHOVER_STATUS` column of the `V$DATABASE` view on the target standby database. For example:

```
SQL> SELECT SWITCHOVER_STATUS FROM V$DATABASE;
```

```
SWITCHOVER_STATUS
-----
TO PRIMARY
1 row selected
```

A value of either `TO PRIMARY` or `SESSIONS ACTIVE` indicates that the standby database is ready to be switched to the primary role. If neither of these values is returned, verify that Redo Apply is active and continue to query this view until either `TO PRIMARY` or `SESSIONS ACTIVE` is returned.

8. Issue the following SQL statement on the target standby database to switch the physical standby to the primary role:

```
SQL> ALTER DATABASE COMMIT TO SWITCHOVER TO PRIMARY WITH SESSION SHUTDOWN;
```

 **Note:**

The `WITH SESSION SHUTDOWN` clause can be omitted from the switchover statement if the query of the `SWITCHOVER_STATUS` column performed in the previous step returned a value of `TO PRIMARY`.

9. Open the new primary database:

```
SQL> ALTER DATABASE OPEN;
```

10. Oracle recommends that you now back up the new primary database.

11. Restart Redo Apply if it has stopped at any of the other physical standby databases in your Oracle Data Guard configuration:

```
SQL> ALTER DATABASE RECOVER MANAGED STANDBY DATABASE -
> DISCONNECT FROM SESSION;
```

12. Optionally, restore the failed primary database.

After a failover, the original primary database can be converted into a physical standby database of the new primary database using the method described in [Converting a Failed Primary Into a Standby Database Using Flashback Database](#) or [Converting a Failed Primary into a Standby Database Using RMAN Backups](#), or it can be re-created as a physical standby database from a backup of the

new primary database using the method described in [Step-by-Step Instructions for Creating a Physical Standby Database](#).

Once the original primary database is running in the standby role, a switchover can be performed to restore it to the primary role.

## G.3 Troubleshooting Switchovers to Physical Standby Databases

These are some of the problems that can occur during a switchover to a physical standby database.

### Note:

The following troubleshooting topics apply only when you are performing switchovers and failovers to a physical standby database using procedures available in releases prior to Oracle Database 12c Release 1 (12.1).

- [Switchover Fails Because Redo Data Was Not Transmitted](#)
- [Switchover Fails with the ORA-01102 Error](#)
- [Redo Data Is Not Applied After Switchover](#)
- [Roll Back After Unsuccessful Switchover and Start Over](#)

### G.3.1 Switchover Fails Because Redo Data Was Not Transmitted

If a switchover does not complete successfully, you can query the `SEQUENCE#` column in the `V$ARCHIVED_LOG` view to see if the last redo data transmitted from the original primary database was applied on the standby database.

If the last redo data was not transmitted to the standby database, you can manually copy the archived redo log file containing the redo data from the original primary database to the old standby database and register it with the SQL `ALTER DATABASE REGISTER LOGFILE file_specification` statement. If you then start apply services, the archived redo log file is applied automatically. Query the `SWITCHOVER_STATUS` column in the `V$DATABASE` view. A switchover to the primary role is now possible if the `SWITCHOVER_STATUS` column returns `TO PRIMARY` or `SESSIONS ACTIVE`:

```
SQL> SELECT SWITCHOVER_STATUS FROM V$DATABASE;
```

```
SWITCHOVER_STATUS
-----
TO PRIMARY
1 row selected
```

See [Views Relevant to Oracle Data Guard](#) for information about other valid values for the `SWITCHOVER_STATUS` column of the `V$DATABASE` view.

To continue with the switchover, follow the instructions in [Performing a Switchover to a Physical Standby Database Using Old Syntax](#) and try again to switch the target standby database to the primary role.

## G.3.2 Switchover Fails with the ORA-01102 Error

These are some of the possible causes, and solutions, if you receive an ORA-01102 error.

Suppose the standby database and the primary database reside on the same site. After both the `ALTER DATABASE COMMIT TO SWITCHOVER TO PHYSICAL STANDBY` and the `ALTER DATABASE COMMIT TO SWITCHOVER TO PRIMARY` statements are successfully executed, shut down and restart the physical standby database and the primary database.

 **Note:**

It is not necessary to shut down and restart the physical standby database if it has not been opened read-only since the instance was started.

However, the startup of the second database fails with an ORA-01102 cannot mount database in `EXCLUSIVE` mode error.

This could happen during the switchover if you did not set the `DB_UNIQUE_NAME` parameter in the initialization parameter file that is used by the standby database (the original primary database). If the `DB_UNIQUE_NAME` parameter of the standby database is not set, the standby and the primary databases both use the same mount lock and cause the ORA-01102 error during the startup of the second database.

Action: Add `DB_UNIQUE_NAME=unique_database_name` to the initialization parameter file used by the standby database, and shut down and restart the standby and primary databases.

## G.3.3 Redo Data Is Not Applied After Switchover

If archived redo log files are not applied to the new standby database after the switchover, it may be because some environment or initialization parameters were not properly set after the switchover.

Action:

- Check the `tnsnames.ora` file at the new primary site and the `listener.ora` file at the new standby site. There should be entries for a listener at the standby site and a corresponding service name at the primary site.
- Start the listener at the standby site if it has not been started.
- Check if the `LOG_ARCHIVE_DEST_n` initialization parameter was set to properly transmit redo data from the primary site to the standby site. For example, query the `V$ARCHIVE_DEST` fixed view at the primary site as follows:

```
SQL> SELECT DEST_ID, STATUS, DESTINATION FROM V$ARCHIVE_DEST;
```

If you do not see an entry corresponding to the standby site, you need to set `LOG_ARCHIVE_DEST_n` and `LOG_ARCHIVE_DEST_STATE_n` initialization parameters.

- Verify that the `LOG_ARCHIVE_FORMAT` initialization parameter is set correctly at the standby site.

- At the standby site, set the `DB_FILE_NAME_CONVERT` and `LOG_FILE_NAME_CONVERT` initialization parameters. Set the `STANDBY_FILE_MANAGEMENT` initialization parameter to `AUTO` to enable the standby site to automatically add new data files that are created at the primary site.

## G.3.4 Roll Back After Unsuccessful Switchover and Start Over

For physical standby databases in situations where an error occurred and it is not possible to continue with the switchover, it might still be possible to revert the new physical standby database back to the primary role.

Take the following steps:

1. Shut down and mount the new standby database (old primary).
2. Start Redo Apply on the new standby database.
3. Verify that the new standby database is ready to be switched back to the primary role. Query the `SWITCHOVER_STATUS` column of the `V$DATABASE` view on the new standby database. For example:

```
SQL> SELECT SWITCHOVER_STATUS FROM V$DATABASE;

SWITCHOVER_STATUS
-----
TO_PRIMARY
1 row selected
```

A value of `TO PRIMARY` or `SESSIONS ACTIVE` indicates that the new standby database is ready to be switched to the primary role. Continue to query this column until the value returned is either `TO PRIMARY` or `SESSIONS ACTIVE`.

4. Issue the following statement to convert the new standby database back to the primary role:

```
SQL> ALTER DATABASE COMMIT TO SWITCHOVER TO PRIMARY WITH SESSION SHUTDOWN;
```

If this statement is successful, the database runs in the primary database role, and you do not need to perform any more steps.

If this statement is unsuccessful, then continue with Step 5.

5. When the switchover to change the role from primary to physical standby was initiated, a trace file was written in the log directory. This trace file contains the SQL statements required to re-create the original primary control file. Locate the trace file and extract the SQL statements into a temporary file. Execute the temporary file from SQL\*Plus. This reverts the new standby database back to the primary role.
6. Shut down the original physical standby database.
7. Create a new standby control file. This is necessary to resynchronize the primary database and physical standby database. Copy the physical standby control file to the original physical standby system. [Create a Control File for the Standby Database](#) describes how to create a physical standby control file.
8. Restart the original physical standby instance.

If this procedure is successful and archive gap management is enabled, then the FAL processes start and re-archive any missing archived redo log files to the physical standby database. Force a log switch on the primary database

and examine the alert logs on both the primary database and physical standby database to ensure the archived redo log file sequence numbers are correct.

See [Manual Gap Resolution](#) for information about archive gap management and [Setting Archive Tracing](#) for information about locating the trace files.

9. Try the switchover again.

At this point, the Oracle Data Guard configuration has been rolled back to its initial state and you can try the switchover operation again (after correcting any problems that might have led to the initial unsuccessful switchover).

# H

## Using the ALTERNATE Attribute to Configure Remote Alternate Destinations

As of Oracle Database 12c Release 2 (12.2), the preferred method for creating alternate log archive destinations for remote standby databases and far sync instances that take over if the active destination fails is to use the `GROUP` and `PRIORITY` attributes.

For local archiving locations (`LOCATION=...`), the `ALTERNATE` attribute is still used to provide high availability if the original archiving directory becomes unavailable due to disk or network issues that prevent access to the archiving location. But use of the `ALTERNATE` attribute for remote log archive destinations (`SERVICE=...`) is maintained only for backwards compatibility. The examples provided in the following sections for using this method are a follow-on for creating a far sync instance, but they also apply to cascading redo destinations.

After you perform the steps in [Creating and Configuring a Far Sync Instance](#), the far sync instance provides zero data loss capability for the configuration to the terminal standby at a remote site over the WAN. For the configuration to remain protected, but at a reduced protection level, in the event that communication with the far sync instance is lost, you can optionally configure the terminal standby to automatically become the alternate destination. This reduces the amount of data loss by allowing Oracle Data Guard to ship redo asynchronously directly from the primary to the terminal standby, temporarily bypassing the far sync instance.

### See Also:

- [Alternate Destinations](#)

## H.1 Configuring an Alternate Destination

To configure an alternate destination, set these parameters on the primary database.

### Primary Database `chicago`

```
LOG_ARCHIVE_DEST_STATE_2='ENABLE'  
  
LOG_ARCHIVE_DEST_2='SERVICE=chicagoFS SYNC AFFIRM MAX_FAILURE=1  
ALTERNATE=LOG_ARCHIVE_DEST_3  
VALID_FOR=(ONLINE_LOGFILES,PRIMARY_ROLE) DB_UNIQUE_NAME=chicagoFS'  
  
LOG_ARCHIVE_DEST_STATE_3='ALTERNATE'  
  
LOG_ARCHIVE_DEST_3='SERVICE=boston ASYNC ALTERNATE=LOG_ARCHIVE_DEST_2  
VALID_FOR=(ONLINE_LOGFILES,PRIMARY_ROLE) DB_UNIQUE_NAME=boston'
```

This configuration enables Oracle Data Guard to continue sending redo, asynchronously, to the terminal standby `boston` when it can no longer send the redo directly to the far sync instance `chicagoFS`. When the far sync instance becomes available again, Oracle Data Guard automatically resynchronizes the far sync instance `chicagoFS` and returns to the original configuration in which the primary sends redo to the far sync instance and the far sync instance forwards that redo to the terminal standby. When the synchronization is complete, the alternate destination (`LOG_ARCHIVE_DEST_3` in the preceding example) again becomes dormant as the alternate.

In the above case, the `ALTERNATE` remote destination is set up directly between two databases using asynchronous redo transport, so in the event of a failure of the far sync instance, the protection level of the configuration falls back down to maximum performance, with data loss at failover time. For more protection from system or network failures, an additional far sync instance can be configured that provides high availability for the active far sync instance.

In the following configuration, one far sync instance is the preferred active far sync instance and the other is the alternate far sync instance. Configuring an alternate far sync instance provides continued protection for the configuration if the preferred far sync instance fails for some reason, keeping the configuration at maximum availability. The primary automatically starts shipping to the alternate far sync instance if it detects a failure at the preferred far sync instance. If the preferred far sync instance then re-establishes itself, the primary switches back to the preferred far sync instance and puts the alternate far sync instance back into the alternate state.

In these types of configurations, the primary uses only one of the two far sync instances to redistribute redo at any given time.

The second high availability far sync instance would be created using the same steps as given in [Creating and Configuring a Far Sync Instance](#), and then become the alternate to the existing far sync instance instead of the terminal standby. When complete, `chicago` would have the parameters configured as follows (assuming the name `chicagoFS1` as the new far sync instance name).

#### Primary Database `chicago`

```
LOG_ARCHIVE_CONFIG='DG_CONFIG=(chicago,chicagoFS,chicagoFS1,boston)'  
  
LOG_ARCHIVE_DEST_STATE_2='ENABLE'  
  
LOG_ARCHIVE_DEST_2='SERVICE=chicagoFS SYNC AFFIRM MAX_FAILURE=1  
ALTERNATE=LOG_ARCHIVE_DEST_3  
VALID_FOR=(ONLINE_LOGFILES,PRIMARY_ROLE) DB_UNIQUE_NAME=chicagoFS'  
  
LOG_ARCHIVE_DEST_STATE_3='ALTERNATE'  
  
LOG_ARCHIVE_DEST_3='SERVICE=chicagoFS1 SYNC AFFIRM  
ALTERNATE=LOG_ARCHIVE_DEST_2  
VALID_FOR=(ONLINE_LOGFILES,PRIMARY_ROLE) DB_UNIQUE_NAME=chicagoFS1'
```

#### Primary Database `boston`

```
LOG_ARCHIVE_CONFIG='DG_CONFIG=(chicago,chicagoFS,chicagoFS1,boston)'
```



Oracle Data Guard can now continue to synchronously send redo to a far sync instance, maintaining the required zero data loss protection mode of maximum availability in the event that a far sync instance fails for some reason. As before, when the failed far sync instance becomes available again, Oracle Data Guard automatically resynchronizes it and returns to the original configuration in which the primary sends redo to the first far sync instance, which then forwards that redo to the terminal standby. When the synchronization is complete, the alternate destination (`LOG_ARCHIVE_DEST_3` in the preceding example) again becomes dormant as the alternate. But if both far sync instances fail, then redo is not sent to the terminal standby `boston` because there is no third alternate capability. That scenario can be accomplished using the `GROUP` and `PRIORITY` attributes instead of the `ALTERNATE` attribute.

 **See Also:**

- [ALTERNATE](#)
- [GROUP](#)
- [PRIORITY](#)

# Index

## A

---

### activating

- a logical standby database, [9-20](#)
- a physical standby database, [12-17](#)

### Active Data Guard

- and physical standby databases, [2-1](#), [10-2](#)
- and the real-time query feature, [10-3](#)

### adding

- datafiles, [10-19](#), [A-13](#), [A-14](#)
- indexes on logical standby databases, [11-21](#)
- new or existing standby databases, [1-7](#)
- online redo log files, [10-22](#)
- tablespaces, [10-19](#)

### adjusting

- initialization parameter file
- for logical standby database, [4-8](#)

### AFFIRM attribute, [17-2](#)

### ALTER DATABASE statement

- ACTIVATE STANDBY DATABASE clause, [9-20](#), [12-17](#)
- ADD STANDBY LOGFILE clause, [18-1](#)
- ADD STANDBY LOGFILE MEMBER clause, [18-1](#), [A-1](#)
- ADD SUPPLEMENTAL LOG DATA clause, [18-2](#)
- COMMIT TO SWITCHOVER clause, [9-18](#), [9-19](#), [18-2](#)
  - troubleshooting, [G-8](#)
- CREATE STANDBY CONTROLFILE clause, [3-8](#)
  - REUSE clause, [18-2](#)
- DROP STANDBY LOGFILE MEMBER clause, [18-2](#)
- GUARD clause, [11-6](#)
- MOUNT STANDBY DATABASE clause, [18-3](#)
- OPEN READ ONLY clause, [18-3](#)
- PREPARE TO SWITCHOVER clause, [9-17](#), [18-3](#)
- RECOVER MANAGED STANDBY DATABASE clause, [3-12](#), [4-12](#), [18-3](#)
  - canceling, [8-5](#)
  - failover, [18-1](#)
- REGISTER LOGFILE clause, [A-4](#), [G-7](#)
- RENAME FILE clause, [A-1](#)

### ALTER DATABASE statement (*continued*)

- SET STANDBY DATABASE clause
    - TO MAXIMIZE AVAILABILITY clause, [18-4](#)
    - TO MAXIMIZE PERFORMANCE clause, [9-8](#)
    - TO MAXIMIZE PROTECTION clause, [18-4](#)
  - START LOGICAL STANDBY APPLY clause, [8-6](#), [13-6](#), [A-11](#)
    - IMMEDIATE keyword, [8-6](#)
    - starting SQL Apply, [4-12](#)
  - STOP LOGICAL STANDBY APPLY clause, [8-6](#), [9-20](#)
- ### ALTER SESSION DISABLE GUARD statement
- overriding the database guard, [11-20](#)
- ### ALTER SESSION statement
- ENABLE GUARD clause, [18-4](#)
- ### ALTER TABLESPACE statement, [10-21](#), [A-14](#)
- ### alternate archive destinations
- setting up initialization parameters for, [A-3](#)
- ### ALTERNATE attribute, [17-3](#)
- LOG\_ARCHIVE\_DEST\_n initialization parameter, [A-3](#)
- ### application continuity
- support in Oracle Data Guard, [1-10](#)
- ### apply lag
- monitoring in a real-time query environment, [10-4](#)
- ### apply lag tolerance
- configuring in a real-time query environment, [10-4](#)
- ### apply services
- defined, [1-5](#), [8-1](#)
  - delaying application of redo data, [8-3](#), [17-7](#)
  - real-time apply
    - defined, [8-2](#)
  - Redo Apply
    - defined, [8-1](#), [8-4](#)
    - monitoring, [8-5](#)
    - starting, [8-5](#)
    - stopping, [8-5](#)
  - SQL Apply
    - defined, [1-5](#), [8-1](#)
    - monitoring, [8-6](#)

apply services (*continued*)  
 SQL Apply (*continued*)  
 starting, 8-6  
 stopping, 8-6

applying  
 redo data immediately, 8-2  
 redo data on standby database, 1-5, 8-1  
 SQL statements to logical standby  
 databases, 8-5

applying state, 11-13

archive destinations  
 alternate, A-3

archived redo log files  
 accessing information about, 10-29  
 applying  
 Redo Apply technology, 1-5  
 SQL Apply technology, 1-6  
 delaying application, 17-7  
 on the standby database, 8-3  
 deleting unneeded, 11-16  
 destinations  
 disabling, 7-4  
 enabling, 7-4  
 managing gaps, 1-16  
 See also gap management, 1-16  
 redo data transmitted, 1-5, 8-1  
 registering  
 during failover, 9-19  
 standby databases and, 8-5, 8-6, 10-27  
 troubleshooting switchover problems, A-4,  
 G-7

ARCHIVELOG mode  
 software requirements, 2-6

archiving  
 real-time apply, 8-2  
 specifying  
 failure resolution policies for, 17-18  
 to failed destinations, 17-18

ASM  
 See Automatic Storage Management (ASM),  
 15-13

ASYNC attribute, 17-19

attributes  
 deprecated for the LOG\_ARCHIVE\_DEST\_n  
 initialization parameter, 17-1

AUD\$ table  
 replication on logical standbys, C-24

automatic block repair, 10-6

automatic detection of missing log files, 1-5, 1-16

automatic failover, 1-7

Automatic Storage Management (ASM)  
 creating a standby database that uses, 15-13

automatic switchover, 1-7  
 See also switchovers, 9-2

## B

BACKUP INCREMENTAL FROM SCN command  
 scenarios using, 12-15, 12-20

backup operations  
 after unrecoverable operations, 15-12  
 configuring on a physical standby database,  
 1-4  
 offloading on the standby database, 1-16  
 primary databases, 1-2  
 used by the broker, 1-7  
 using RMAN, 12-1

basic readable standby database See simulating  
 a standby database environment, 2-6

batch processing  
 on a logical standby database, 11-4

benefits  
 Data Guard, 1-16  
 logical standby database, 2-2  
 of a rolling upgrade, 13-1  
 physical standby database, 2-1

block repair, automatic, 10-6

broker  
 command-line interface, 1-16  
 defined, 1-7  
 graphical user interface, 1-16

## C

cascaded redo transport destinations, 7-8

cascading redo  
 non-real-time, 7-8  
 real-time, 7-8

cascading redo data, 7-8  
 configuration requirements, 7-9  
 restrictions, 7-9

CDBs  
 creating a logical standby of, 4-13  
 creating a physical standby of, 3-16

character sets  
 changing on primary databases, 15-23  
 configurations with differing, C-25

checklist  
 tasks for creating physical standby  
 databases, 3-7  
 tasks for creating standby databases, 4-4

checkpoints  
 V\$LOGSTDBY\_PROGRESS view, 11-4

chunking  
 transactions, 11-3

command-line interface  
 broker, 1-16

COMMIT TO SWITCHOVER clause  
 of ALTER DATABASE, 9-18, 9-19, 18-2  
 troubleshooting, G-8

- COMPATIBLE initialization parameter
    - setting after upgrading Oracle Database software, [B-5](#)
    - setting for a rolling upgrade, [13-10](#)
  - complementary technologies, [1-10](#)
  - COMPRESSION attribute, [17-5](#)
  - configuration options
    - creating with Data Guard broker, [1-7](#)
    - overview, [1-1](#)
    - physical standby databases
      - location and directory structure, [2-7](#)
    - standby databases
      - delayed standby, [8-3](#)
  - configuring
    - backups on standby databases, [1-4](#)
    - disaster recovery, [1-4](#)
    - initialization parameters
      - for alternate archive destinations, [A-3](#)
    - listener for physical standby databases, [5-3](#)
    - no data loss, [1-6](#)
    - physical standby databases, [2-7](#)
    - reporting operations on a logical standby database, [1-4](#)
    - standby databases at remote locations, [1-4](#)
  - constraints
    - handled on a logical standby database, [11-26](#)
  - control files
    - copying, [3-11](#)
    - creating for standby databases, [3-8](#)
  - CONVERT TO SNAPSHOT STANDBY clause on the ALTER DATABASE statement, [18-2](#)
  - converting
    - a logical standby database to a physical standby database
      - terminating, [4-8](#)
    - a physical standby database to a logical standby database, [4-7](#)
  - COORDINATOR process
    - LSP background process, [11-2](#)
  - copying
    - control files, [3-11](#)
  - CREATE STANDBY CONTROLFILE clause of ALTER DATABASE, [3-8](#), [18-2](#)
  - CREATE TABLE AS SELECT (CTAS) statements
    - applied on a logical standby database, [11-5](#)
  - creating
    - indexes on logical standby databases, [11-21](#)
- ## D
- 
- data availability
    - balancing against system performance requirements, [1-16](#)
  - Data Guard broker
    - defined, [1-7](#)
  - Data Guard broker (*continued*)
    - distributed management framework, [9-1](#)
    - failovers, [1-7](#)
      - fast-start, [9-1](#)
      - manual, [1-7](#), [9-1](#)
    - fast-start failover, [1-7](#)
    - switchovers, [9-1](#)
  - Data Guard configurations
    - archiving to standby destinations using the log writer process, [8-2](#)
    - defined, [1-1](#)
    - protection modes, [1-8](#)
    - upgrading Oracle Database software, [B-1](#)
  - data loss
    - due to failover, [1-7](#)
    - switchover and, [9-2](#)
  - data protection
    - balancing against performance, [1-16](#)
    - flexibility, [1-16](#)
    - provided by Data Guard, [1-1](#)
  - data protection modes
    - enforced by redo transport services, [1-5](#)
    - overview, [1-8](#)
  - Data Pump utility
    - using transportable tablespaces with physical standby databases, [10-20](#)
  - database caching modes
    - force full database caching
      - status in Data Guard configurations, [10-8](#)
  - database guard, [11-20](#)
    - overriding, [11-20](#)
  - database incarnation
    - changes with OPEN RESETLOGS, [10-24](#)
  - database roles
    - primary, [9-2](#)
    - standby, [1-2](#), [9-2](#)
    - transitions, [1-7](#)
  - database schema
    - physical standby databases, [1-2](#)
  - databases
    - failover and, [9-7](#)
    - role transition and, [9-2](#)
    - surviving disasters and data corruptions, [1-1](#)
    - upgrading software versions, [13-1](#)
  - datafiles
    - adding to primary database, [10-19](#)
    - monitoring, [10-27](#)
    - renaming on the primary database, [10-21](#)
  - DB\_FILE\_NAME\_CONVERT initialization parameter
    - setting at standby site after a switchover, [A-5](#), [G-9](#)
    - setting on physical standby database, [3-10](#)
    - when planning standby location and directory structure, [2-10](#)

- DB\_ROLE\_CHANGE system event, [9-8](#)
  - DB\_UNIQUE\_NAME attribute, [17-6](#)
  - DB\_UNIQUE\_NAME initialization parameter,
    - [A-5](#), [G-8](#)
    - required with LOG\_ARCHIVE\_CONFIG parameter, [16-2](#)
    - setting database initialization parameters, [3-5](#)
  - DBA\_LOGMNR\_PURGED\_LOG view
    - list archived redo log files that can be deleted, [11-16](#)
  - DBA\_LOGSTDBY\_EVENTS view, [11-7](#), [19-1](#), [A-11](#)
  - DBA\_LOGSTDBY\_HISTORY view, [19-1](#)
  - DBA\_LOGSTDBY\_LOG view, [11-8](#), [19-1](#)
  - DBA\_LOGSTDBY\_NOT\_UNIQUE view, [19-1](#)
  - DBA\_LOGSTDBY\_PARAMETERS view, [19-1](#)
  - DBA\_LOGSTDBY\_SKIP view, [19-1](#)
  - DBA\_LOGSTDBY\_SKIP\_TRANSACTION view, [19-1](#)
  - DBA\_LOGSTDBY\_UNSUPPORTED view, [19-1](#)
  - DBA\_TABLESPACES view, [10-27](#)
  - DBMS\_LOGSTDBY package
    - INSTANTIATE\_TABLE procedure, [11-23](#)
    - SKIP procedure, [A-11](#)
    - SKIP\_ERROR procedure, [A-3](#)
    - SKIP\_TRANSACTION procedure, [A-11](#)
  - DBMS\_LOGSTDBY.BUILD procedure
    - building a dictionary in the redo data, [4-6](#)
  - DBMS\_ROLLING package
    - used for rolling upgrades, [14-1](#)
  - DDL statements
    - supported by SQL Apply, [C-1](#)
  - DDL Statements
    - that use DBLINKS, [C-23](#)
  - DDL transactions
    - applied on a logical standby database, [11-4](#)
    - applying to a logical standby database, [11-4](#)
  - DELAY attribute, [17-7](#)
    - LOG\_ARCHIVE\_DEST\_n initialization parameter, [8-4](#)
  - delaying
    - application of archived redo log files, [17-7](#)
    - application of redo log files, [8-3](#)
  - deleting
    - archived redo log files
      - indicated by the
        - DBA\_LOGMNR\_PURGED\_LOG view, [11-16](#)
      - not needed by SQL Apply, [11-16](#)
  - deprecated attributes
    - on the LOG\_ARCHIVE\_DEST\_n initialization parameter, [17-1](#)
  - destinations
    - displaying with V\$ARCHIVE\_DEST view, [19-1](#)
  - destinations (*continued*)
    - role-based definitions, [17-21](#)
  - detecting
    - missing archived redo log files, [1-5](#), [1-16](#)
  - DGMGRL command-line interface
    - invoking failovers, [1-7](#), [9-1](#)
    - simplifying switchovers, [1-7](#), [9-1](#)
  - dictionary
    - building a LogMiner, [4-6](#)
  - direct path inserts
    - SQL Apply DML considerations, [11-4](#)
  - directory locations
    - Optimal Flexible Architecture (OFA), [2-7](#)
    - structure on standby databases, [2-7](#)
  - disabling
    - a destination for archived redo log files, [7-4](#)
  - disaster recovery
    - configuring, [1-4](#)
    - provided by Oracle Data Guard, [1-1](#)
    - provided by standby databases, [1-4](#)
  - disk I/O
    - controlling with the AFFIRM and NOAFFIRM attributes, [17-2](#)
  - distributed transactions, [C-24](#)
  - DML
    - batch updates on a logical standby database, [11-4](#)
  - DML operations
    - on temporary tables, [10-11](#)
  - DML transactions
    - applying to a logical standby database, [11-4](#)
  - downgrading
    - Oracle Database software, [B-7](#)
  - DROP STANDBY LOGFILE MEMBER clause
    - of ALTER DATABASE, [18-2](#)
  - dropping
    - online redo log files, [10-22](#)
- ## E
- 
- ENABLE GUARD clause
    - of ALTER SESSION, [18-4](#)
  - enabling
    - database guard on logical standby databases, [18-4](#)
    - destinations for archived redo log files, [7-4](#)
    - real-time apply
      - on logical standby databases, [8-6](#)
- ## F
- 
- failovers, [1-6](#)
    - Data Guard broker, [1-7](#), [9-1](#)
    - defined, [1-6](#)

failovers (*continued*)

- displaying history with  
DBA\_LOGSTDBY\_HISTORY, [19-1](#)
- fast-start failover, [9-1](#)
- flashing back databases after, [9-21](#)
- logical standby databases and, [9-19](#)
- manual versus automatic, [1-7](#)
- physical standby databases and, [18-1](#)
- preparing for, [9-8](#)
- simplifying with Data Guard broker, [9-1](#)
- transferring redo data before, [9-8](#)
- viewing characteristics for logical standby  
databases, [11-9](#)
- with maximum performance mode, [9-8](#)
- with maximum protection mode, [9-8](#)

failure resolution policies

- specifying for redo transport services, [17-18](#)

far sync instances, [5-1](#)

- creating, [5-2](#)
- supported protection modes, [5-13](#)

fast-start failover

- automatic failover, [1-7](#), [9-1](#)
- monitoring, [10-26](#)

FastSync mode, [6-2](#)

FGA\_LOG\$ table

- replication on logical standbys, [C-24](#)

file specifications

- renaming on the logical standby database,  
[11-19](#)

Flashback Database

- after a role transition, [9-21](#)
- after OPEN RESETLOGS, [15-7](#)
- after role transitions, [9-21](#)
- characteristics complementary to Data  
Guard, [1-10](#)
- physical standby database, [15-4](#)

force full database caching mode

- status in Data Guard configurations, [10-8](#)

## G

---

gap management

- automatic detection and resolution, [1-5](#), [1-16](#)
- detecting missing log files, [1-16](#)
- registering archived redo log files  
during failover, [9-19](#)

Global Data Services, [1-10](#)

global temporary tables

- DML operations, [10-11](#)
- using with Active Data Guard, [10-11](#)

## H

---

high availability

- Oracle Real Application Clusters  
characteristics complementary to Data  
Guard, [1-10](#)
- provided by Oracle Data Guard, [1-1](#)
- provided by Oracle RAC and Data Guard,  
[1-10](#)

## I

---

idle state, [11-13](#)

incarnation of a database

- changed, [10-24](#)

initialization parameters

- DB\_UNIQUE\_NAME, [3-5](#), [A-5](#), [G-8](#)
- LOG\_ARCHIVE\_MIN\_SUCCEED\_DEST,  
[17-13](#)
- LOG\_FILE\_NAME\_CONVERT, [E-4](#)
- setting for both the primary and standby  
roles, [17-21](#)

INITIALIZING state, [11-13](#)

INSTANTIATE\_TABLE procedure

- of DBMS\_LOGSTDBY, [11-23](#)

## K

---

KEEP IDENTITY clause, [4-8](#)

## L

---

latency

- on logical standby databases, [11-4](#)

listener.ora file

- redo transport services tuning and, [A-11](#)
- troubleshooting, [A-2](#), [A-11](#)

loading dictionary state, [11-14](#)

LOCATION attribute, [17-11](#)

- setting  
LOG\_ARCHIVE\_DEST\_n initialization  
parameter, [A-3](#)

log apply services

- Redo Apply  
monitoring, [10-27](#)
- starting, [10-1](#)
- stopping, [10-2](#)
- tuning for Redo Apply, [10-31](#)

log writer process (LGWR)

- ASYN network transmission, [17-19](#)
- NET\_TIMEOUT attribute, [17-15](#)
- SYNC network transmission, [17-19](#)

- LOG\_ARCHIVE\_CONFIG initialization
  - parameter, [3-5](#), [3-9](#)
  - example, [17-7](#)
  - listing unique database names defined with, [19-2](#)
  - relationship to DB\_UNIQUE\_NAME parameter, [16-2](#)
- LOG\_ARCHIVE\_DEST\_n initialization parameter
  - AFFIRM attribute, [17-2](#)
  - ALTERNATE attribute, [17-3](#), [A-3](#)
  - ASYNCR attribute, [17-19](#)
  - COMPRESSION attribute, [17-5](#)
  - DB\_UNIQUE\_NAME attribute, [17-6](#)
  - DELAY attribute, [8-4](#), [17-7](#)
  - deprecated attributes, [17-1](#)
  - LOCATION attribute, [17-11](#), [A-3](#)
  - MANDATORY attribute, [17-12](#)
  - MAX\_FAILURE attribute, [17-13](#)
  - NET\_TIMEOUT attribute, [17-15](#)
  - NOAFFIRM attribute, [17-2](#)
  - NOALTERNATE attribute, [A-3](#)
  - NODELAY attribute, [8-4](#)
  - NOREGISTER attribute, [17-16](#)
  - REOPEN attribute, [17-18](#)
  - SERVICE attribute, [17-11](#)
  - SYNC attribute, [17-19](#)
  - VALID\_FOR attribute, [17-21](#)
- LOG\_ARCHIVE\_MIN\_SUCCEED\_DEST initialization parameter, [17-13](#)
- LOG\_FILE\_NAME\_CONVERT initialization parameter
  - setting at standby site after a switchover, [A-5](#), [G-9](#)
  - setting on physical standby databases, [3-10](#)
  - when planning standby location and directory structure, [2-10](#)
- logical change records (LCR)
  - exhausted cache memory, [11-3](#)
  - staged, [11-2](#)
- logical standby databases, [1-2](#)
  - adding
    - datafiles, [A-13](#)
    - indexes, [11-21](#)
    - tables, [11-23](#)
  - background processes, [11-2](#)
  - benefits, [2-2](#)
  - controlling user access to tables, [11-6](#)
  - creating, [4-1](#)
    - converting from a physical standby database, [4-7](#)
    - with Data Guard broker, [1-7](#)
  - data types
    - supported, [C-1](#), [C-2](#)
    - unsupported, [C-4](#)
- logical standby databases (*continued*)
  - database guard
    - overriding, [11-20](#)
  - executing SQL statements on, [1-2](#)
  - failovers, [9-19](#)
    - displaying history of, [19-1](#)
    - handling failures, [A-3](#)
    - viewing characteristics with V\$LOGSTDBY\_STATS, [11-9](#)
  - logical standby process (LSP) and, [11-2](#)
  - materialized views
    - support for, [C-19](#)
  - monitoring, [8-6](#), [19-1](#)
  - renaming the file specification, [11-19](#)
  - setting up a skip handler, [11-19](#)
  - SQL Apply, [1-6](#)
    - resynchronizing with primary database branch of redo, [11-29](#)
    - skipping DDL statements, [C-19](#)
    - skipping SQL statements, [C-19](#)
    - starting real-time apply, [8-6](#)
    - stopping, [8-6](#)
    - technology, [8-1](#)
    - transaction size considerations, [11-3](#)
  - starting
    - real-time apply, [8-6](#)
  - states
    - applying, [11-13](#)
    - idle, [11-13](#)
    - initializing, [11-13](#)
    - loading dictionary, [11-14](#)
  - support for primary databases with Transparent Data Encryption, [C-5](#)
  - switchovers, [9-16](#)
  - throughput and latency, [11-4](#)
  - upgrading, [B-4](#)
    - rolling upgrades, [2-6](#)
- logical standby process (LSP)
  - COORDINATOR process, [11-2](#)
- LogMiner dictionary
  - using DBMS\_LOGSTDBY.BUILD procedure to build, [4-6](#)
  - when creating a logical standby database, [4-8](#)

---

## M

- managed recovery operations
  - See Redo Apply
- MANDATORY attribute, [17-12](#)
- MAX\_FAILURE attribute, [17-13](#)
- maximum availability mode
  - introduction, [1-8](#)
- maximum performance mode, [9-8](#)
  - introduction, [1-8](#)

maximum performance protection mode, [6-2](#)  
 maximum protection mode  
     for Oracle Real Application Clusters, [D-5](#)  
     introduction, [1-8](#)  
     standby databases and, [9-8](#)  
 memory  
     exhausted LCR cache, [11-3](#)  
 missing log sequence  
     detecting, [1-16](#)  
     See also gap management, [1-16](#)  
 modifying  
     a logical standby database, [11-20](#)  
 monitoring  
     primary database events, [10-26](#)  
     tablespace status, [10-27](#)  
 MOUNT STANDBY DATABASE clause  
     of ALTER DATABASE, [18-3](#)  
 multitenant container databases  
     See CDBs, [3-16](#), [4-13](#)

## N

---

NET\_TIMEOUT attribute, [17-15](#)  
 network I/O operations  
     network timers  
         NET\_TIMEOUT attribute, [17-15](#)  
     tuning  
         redo transport services, [A-11](#)  
 network timeouts  
     acknowledging, [17-15](#)  
 no data loss  
     data protection modes overview, [1-8](#)  
     ensuring, [1-7](#)  
     guaranteeing, [1-7](#)  
     provided by maximum availability mode, [1-8](#)  
     provided by maximum protection mode, [1-8](#)  
 NOAFFIRM attribute, [17-2](#)  
 NOALTERNATE attribute  
     LOG\_ARCHIVE\_DEST\_n initialization  
         parameter, [A-3](#)  
 NODELAY attribute  
     LOG\_ARCHIVE\_DEST\_n initialization  
         parameter, [8-4](#)  
 NOREGISTER attribute, [17-16](#)

## O

---

OMF  
     See Oracle Managed Files (OMF), [15-13](#)  
 on-disk database structures  
     physical standby databases, [1-2](#)  
 online data files  
     moving the location, [2-10](#)  
 online redo log files  
     adding, [10-22](#)

online redo log files (*continued*)  
     dropping, [10-22](#)  
 OPEN READ ONLY clause  
     of ALTER DATABASE, [18-3](#)  
 OPEN RESETLOGS  
     flashing back after, [15-7](#)  
 OPEN RESETLOGS clause  
     database incarnation change, [10-24](#)  
     recovery, [10-24](#)  
 operational requirements, [2-5](#)  
 Optimal Flexible Architecture (OFA)  
     directory structure, [2-7](#)  
 ORA-01102 message  
     causing switchover failures, [A-5](#), [G-8](#)  
 Oracle Database software  
     requirements for upgrading with SQL Apply,  
         [13-2](#)  
     upgrading, [2-6](#), [B-1](#)  
     upgrading with SQL Apply, [13-1](#)  
 Oracle Enterprise Manager  
     invoking failovers, [1-7](#), [9-1](#)  
     invoking switchovers, [1-7](#), [9-1](#)  
 Oracle Managed Files (OMF)  
     creating a standby database that uses, [15-13](#)  
 Oracle RAC One Node  
     supported by Oracle Data Guard, [1-10](#)  
 Oracle Real Application Clusters  
     primary databases and, [1-2](#), [D-2](#)  
     setting  
         maximum data protection, [D-5](#)  
         standby databases and, [1-2](#), [D-1](#)  
 Oracle Recovery Manager utility (RMAN)  
     backing up files on a physical standby  
         database, [12-1](#)  
 Oracle Sharding  
     supported by Oracle Active Data Guard, [1-12](#)  
 Oracle Standard Edition  
     simulating a standby database environment,  
         [2-6](#)

## P

---

pageout considerations, [11-3](#)  
 pageouts  
     SQL Apply, [11-3](#)  
 parallel DML (PDML) transactions  
     SQL Apply, [11-4](#)  
 patch set releases  
     upgrading, [2-6](#)  
 performance  
     balancing against data availability, [1-16](#)  
     balancing against data protection, [1-16](#)  
 physical standby databases  
     and Oracle Active Data Guard, [2-1](#)



- physical standby databases (*continued*)
    - applying redo data, [8-1](#), [8-4](#)
      - Redo Apply technology, [8-4](#)
    - applying redo log files
      - starting, [8-5](#)
    - benefits, [2-1](#)
    - configuration options, [2-7](#)
    - converting datafile path names, [3-10](#)
    - converting log file path names, [3-10](#)
    - converting to a logical standby database, [4-7](#)
    - creating
      - checklist of tasks, [3-7](#)
      - configuring a listener, [5-3](#)
      - directory structure, [2-7](#)
      - with Data Guard broker, [1-7](#)
    - defined, [1-2](#)
    - failover
      - checking for updates, [9-8](#)
    - flashing back after failover, [15-4](#)
    - monitoring, [8-5](#), [10-27](#), [19-1](#)
    - opening for read-only or read/write access, [10-2](#)
    - read-only, [10-2](#)
    - recovering through OPEN RESETLOGS, [10-24](#)
    - Redo Apply, [1-5](#)
    - resynchronizing with primary database
      - branch of redo, [10-24](#)
    - role transition and, [9-9](#), [G-1](#)
    - rolling forward with BACKUP INCREMENTAL FROM SCN command, [12-15](#), [12-20](#)
    - shutting down, [10-2](#)
    - starting
      - apply services, [8-5](#)
      - tuning the log apply rate, [10-31](#)
      - upgrading, [B-3](#)
      - using transportable tablespaces, [10-20](#)
  - PL/SQL supplied packages
    - supported, [C-10](#)
    - unsupported, [C-11](#)
  - PREPARE TO SWITCHOVER clause
    - of ALTER DATABASE, [9-17](#), [18-3](#)
  - PREPARER process
    - staging LCRs in SGA, [11-2](#)
  - primary database
    - configuring
      - on Oracle Real Application Clusters, [1-2](#)
      - single-instance, [1-2](#)
    - datafiles
      - adding, [10-19](#)
    - defined, [1-2](#)
    - gap resolution, [1-16](#)
    - monitoring events on, [10-26](#)
    - network connections
      - avoiding network hangs, [17-16](#)
  - primary database (*continued*)
    - network connections (*continued*)
      - handling network timeouts, [17-15](#)
    - Oracle Real Application Clusters and
      - setting up, [D-2](#)
    - preparing for
      - physical standby database creation, [3-2](#)
    - prerequisite conditions for
      - logical standby database creation, [4-1](#)
      - redo transport services on, [1-5](#)
      - reducing workload on, [1-16](#)
    - restore points
      - replicating to standby, [10-30](#)
    - switchover, [9-4](#)
    - tablespaces
      - adding, [10-19](#)
  - primary databases
    - ARCHIVELOG mode, [2-6](#)
    - software requirements, [2-5](#)
  - primary key columns
    - logged with supplemental logging, [4-6](#), [11-4](#)
  - private temporary tables
    - using with Active Data Guard, [10-13](#)
  - processes
    - SQL Apply architecture, [11-1](#), [11-13](#)
  - protection modes
    - maximum availability mode, [1-8](#)
    - maximum performance, [6-2](#)
    - maximum performance mode, [1-8](#)
    - maximum protection mode, [1-8](#)
    - monitoring, [10-26](#)
    - setting on a primary database, [6-3](#)
- ## Q
- 
- queries
    - offloading on the standby database, [1-16](#)
- ## R
- 
- re-creating
    - a table on a logical standby database, [11-23](#)
  - read-only operations, [1-5](#)
    - physical standby databases and, [10-2](#)
  - real-time apply
    - defined, [8-2](#)
    - starting
      - on logical standby, [8-6](#)
    - starting on logical standby databases, [8-6](#)
    - stopping
      - on logical standby, [8-6](#)
      - on physical standby databases, [10-2](#)
  - real-time cascading, [7-8](#)
  - real-time query feature, [10-2](#)
    - and Oracle Active Data Guard, [10-2](#), [10-3](#)

- real-time query feature (*continued*)
  - configuring apply lag tolerance, [10-4](#)
  - forcing Redo Apply synchronization, [10-5](#)
  - monitoring apply lag, [10-4](#)
  - restrictions, [10-5](#)
  - using, [10-3](#)
- RECOVER MANAGED STANDBY DATABASE
  - CANCEL clause
    - terminating, [4-8](#)
- RECOVER MANAGED STANDBY DATABASE clause
  - of ALTER DATABASE, [3-12](#), [4-12](#), [8-5](#), [18-1](#), [18-3](#)
- RECOVER TO LOGICAL STANDBY clause
  - converting a physical standby database to a logical standby database, [4-7](#)
- recovering
  - from errors, [A-12](#)
  - logical standby databases, [11-29](#)
  - physical standby databases
    - after an OPEN RESETLOGS, [10-24](#)
    - through resetlogs, [10-24](#), [11-29](#)
- Recovery Manager
  - characteristics complementary to Data Guard, [1-10](#)
  - standby database
    - creating, [E-1](#)
    - LOG\_FILE\_NAME\_CONVERT
      - initialization parameter, [E-4](#)
    - preparing using RMAN, [E-2](#)
- redirecting DML operations
  - standby databases, [10-9](#)
- redirecting PL/SQL
  - standby databases, [10-10](#)
- Redo Apply, [2-1](#)
  - defined, [1-5](#), [8-1](#)
  - flashing back after failover, [15-4](#)
  - starting, [3-12](#)
  - stopping, [10-2](#)
  - technology, [1-5](#)
  - tuning the log apply rate, [10-31](#)
- redo data
  - applying
    - through Redo Apply technology, [1-5](#)
    - through SQL Apply technology, [1-6](#)
    - to standby database, [8-1](#)
    - to standby databases, [1-2](#)
  - applying during conversion of a physical standby database to a logical standby database, [4-8](#)
  - archiving on the standby system, [1-5](#), [8-1](#)
  - building a dictionary in, [4-6](#)
  - cascading, [7-8](#)
  - transmitting, [1-2](#), [1-5](#)
- redo gaps, [7-14](#)
  - manual resolution, [7-14](#)
  - reducing resolution time, [7-14](#)
- redo log files
  - delaying application, [8-3](#)
- redo logs
  - automatic application on physical standby databases, [8-5](#)
  - update standby database tables, [1-16](#)
- redo transport services, [7-1](#)
  - archive destinations
    - alternate, [A-3](#)
    - re-archiving to failed destinations, [17-18](#)
  - authenticating sessions
    - using SSL, [7-3](#)
  - configuring, [7-2](#)
  - configuring security, [7-2](#)
  - defined, [1-5](#)
  - gap detection, [7-14](#)
  - handling archive failures, [17-18](#)
  - monitoring status, [7-12](#)
  - network
    - tuning, [A-11](#)
  - protection modes
    - maximum availability mode, [1-8](#)
    - maximum performance mode, [1-8](#)
    - maximum protection mode, [1-8](#)
  - receiving redo data, [7-7](#)
  - sending redo data, [7-4](#)
  - synchronous and asynchronous disk I/O, [17-2](#)
  - wait events, [7-17](#)
- REGISTER LOGFILE clause
  - of ALTER DATABASE, [A-4](#), [G-7](#)
- REGISTER LOGICAL LOGFILE clause
  - of ALTER DATABASE, [9-19](#)
- registering
  - archived redo log files
    - during failover, [9-19](#)
- RELY constraint
  - creating, [4-3](#)
- remote file server process (RFS)
  - log writer process and, [8-2](#)
- RENAME FILE clause
  - of ALTER DATABASE, [A-1](#)
- renaming
  - datafiles
    - on the primary database, [10-21](#)
    - setting the
      - STANDBY\_FILE\_MANAGEMENT parameter, [10-21](#)
- REOPEN attribute, [17-18](#)
- reporting operations
  - configuring, [1-4](#)
  - offloading on the standby database, [1-16](#)

- requirements
  - of a rolling upgrade, [13-2](#)
- restart considerations
  - SQL Apply, [11-4](#)
- restore points
  - replicating to standby, [10-30](#)
- resynchronizing
  - logical standby databases with a new branch of redo, [11-29](#)
  - physical standby databases with a new branch of redo, [10-24](#)
- retrieving
  - missing archived redo log files, [1-5](#), [1-16](#)
- RMAN BACKUP INCREMENTAL FROM SCN
  - command, [12-15](#), [12-20](#)
- RMAN backups
  - accessibility in Data Guard environment, [12-3](#)
  - association in Data Guard environment, [12-2](#)
  - interchangeability in Data Guard environment, [12-2](#)
- role management services
  - defined, [9-1](#)
- role transition triggers, [9-8](#)
  - DB\_ROLE\_CHANGE system event, [9-8](#)
- role transitions, [1-7](#), [9-2](#)
  - choosing a type of, [9-2](#)
  - defined, [1-6](#)
  - flashing back the databases after, [9-21](#)
  - logical standby database and, [9-16](#)
  - monitoring, [10-26](#)
  - physical standby databases and, [9-9](#), [G-1](#)
  - reversals, [1-7](#), [9-2](#)
- role-based destinations
  - setting, [17-21](#)
- rollback
  - after switchover failures, [A-6](#), [G-9](#)
- rolling upgrade
  - software requirements, [2-6](#)
- rolling upgrades
  - benefits, [13-1](#)
  - DBMS\_ROLLING package, [14-1](#)
  - patch set releases, [2-6](#)
  - requirements, [13-2](#)
  - setting the COMPATIBLE initialization parameter, [13-10](#)
  - use of KEEP IDENTITY clause, [4-8](#)
  - using Active Data Guard, [14-1](#)
- sequences
  - unsupported on logical standby databases, [C-16](#)
  - using in Oracle Active Data Guard, [10-14](#)
- SERVICE attribute, [17-11](#)
- SET STANDBY DATABASE clause
  - of ALTER DATA, [18-4](#)
  - of ALTER DATABASE, [9-8](#), [18-4](#)
- shutting down
  - physical standby database, [10-2](#)
- simulating
  - standby database environment, [2-6](#)
- skip handler
  - setting up on a logical standby database, [11-19](#)
- SKIP procedure
  - of DBMS\_LOGSTDBY, [A-11](#)
- SKIP\_ERROR procedure
  - of the DBMS\_LOGSTDBY package, [A-3](#)
- SKIP\_TRANSACTION procedure
  - of DBMS\_LOGSTDBY, [A-11](#)
- snapshot standby databases, [1-2](#)
  - managing, [10-32](#)
- software requirements, [2-5](#)
  - rolling upgrades, [2-6](#)
- SQL Apply, [8-6](#), [11-3](#)
  - after an OPEN RESETLOGS, [11-29](#)
  - applying CREATE TABLE AS SELECT (CTAS) statements, [11-5](#)
  - applying DDL transactions, [11-4](#)
  - applying DML transactions, [11-4](#)
  - architecture, [11-1](#), [11-13](#)
  - defined, [1-6](#), [8-1](#)
  - deleting archived redo log files, [11-16](#)
  - parallel DML (PDML) transactions, [11-4](#)
  - performing a rolling upgrade, [13-1](#)
  - requirements for rolling upgrades, [13-2](#)
  - restart considerations, [11-4](#)
  - rolling upgrades, [2-6](#)
  - starting
    - real-time apply, [8-6](#)
  - stopping
    - real-time apply, [8-6](#)
  - support for DDL statements, [C-1](#)
  - support for PL/SQL supplied packages, [C-10](#)
  - supported data types, [C-2](#)
  - transaction size considerations, [11-3](#)
  - unsupported data types, [C-4](#)
  - unsupported PL/SQL supplied packages, [C-11](#)
  - what to do if it stops, [A-10](#)
- SQL statements
  - executing on logical standby databases, [1-2](#), [1-6](#)
  - skipping on logical standby databases, [C-19](#)

---

## S

- schemas
  - identical to primary database, [1-2](#)

- standby database
    - creating logical, [4-1](#)
  - standby databases
    - about creating using RMAN, [E-1](#)
    - apply services on, [8-1](#)
    - applying redo data on, [8-1](#)
    - applying redo log files on, [1-5](#), [1-16](#)
    - configuring, [1-1](#)
      - maximum number of, [2-1](#)
      - on Oracle Real Application Clusters, [1-2](#), [D-1](#)
      - on remote locations, [1-4](#)
      - single-instance, [1-2](#)
    - creating, [1-2](#)
      - checklist of tasks, [4-4](#)
      - directory structure considerations, [2-7](#)
      - if primary uses ASM or OMF, [15-13](#)
      - on remote host with same directory structure, [E-4](#)
      - with a time lag, [8-3](#)
    - defined, [2-1](#)
    - failover
      - preparing for, [9-8](#)
    - failover to, [9-7](#)
    - LOG\_FILE\_NAME\_CONVERT initialization parameter, [E-4](#)
    - operational requirements, [2-5](#)
    - preparing to use RMAN, [E-2](#)
    - recovering through OPEN RESETLOGS, [10-24](#)
    - redirecting DML operations, [10-9](#)
    - redirecting PL/SQL, [10-10](#)
    - resynchronizing with the primary database, [1-16](#)
    - software requirements, [2-5](#)
    - starting apply services on physical, [8-5](#)
  - standby redo log files
    - and real-time apply, [8-2](#)
  - standby redo logs
    - creating and managing, [7-7](#)
  - standby role, [1-2](#)
  - STANDBY\_FILE\_MANAGEMENT initialization parameter
    - when renaming datafiles, [10-21](#)
  - START LOGICAL STANDBY APPLY clause
    - IMMEDIATE keyword, [8-6](#)
    - of ALTER DATABASE, [4-12](#), [8-6](#), [13-6](#), [A-11](#)
  - starting
    - logical standby databases, [4-10](#)
    - physical standby databases, [3-12](#)
    - real-time apply, [8-6](#)
      - on logical standby databases, [8-6](#)
    - Redo Apply, [10-1](#)
    - SQL Apply, [4-12](#), [8-6](#)
  - STOP LOGICAL STANDBY APPLY clause
    - of ALTER DATABASE, [8-6](#), [9-20](#)
  - stopping
    - real-time apply
      - on logical standby databases, [8-6](#)
    - real-time apply on physical standby databases, [8-5](#)
    - Redo Apply, [8-5](#)
    - SQL Apply, [8-6](#)
  - streams capture
    - running on a logical standby, [11-29](#)
  - supplemental logging
    - setting up to log primary key and unique-index columns, [4-6](#), [11-4](#)
  - supported data types
    - for logical standby databases, [C-1](#), [C-20](#)
  - supported PL/SQL supplied packages, [C-10](#)
  - SWITCHOVER\_STATUS column
    - of V\$DATABASE view, [A-4](#), [G-7](#)
  - switchovers, [1-6](#)
    - choosing a target standby database, [9-3](#)
    - defined, [1-6](#)
    - displaying history with
      - DBA\_LOGSTDBY\_HISTORY, [19-1](#)
    - fails with ORA-01102, [A-5](#), [G-8](#)
    - flashing back databases after, [9-21](#)
    - logical standby databases and, [9-16](#)
    - manual versus automatic, [1-7](#)
    - monitoring, [10-26](#)
    - no data loss and, [9-2](#)
    - preparing for, [9-4](#)
    - seeing if the last archived redo log file was transmitted, [A-4](#), [G-7](#)
    - setting DB\_FILE\_NAME\_CONVERT after, [A-5](#), [G-9](#)
    - setting LOG\_FILE\_NAME\_CONVERT after, [A-5](#), [G-9](#)
    - simplifying with Data Guard broker, [1-7](#), [9-1](#)
    - starting over, [A-6](#), [G-9](#)
    - typical use for, [9-4](#)
  - SYNC attribute, [17-19](#)
  - system events
    - role transitions, [9-8](#)
  - system global area (SGA)
    - logical change records staged in, [11-2](#)
  - system resources
    - efficient utilization of, [1-16](#)
- ## T
- 
- tables
    - logical standby databases
      - adding on, [11-23](#)
      - re-creating tables on, [11-23](#)
      - unsupported on, [C-16](#)

tablespaces  
 adding  
   a new datafile, [A-14](#)  
   to primary database, [10-19](#)  
   monitoring status changes, [10-27](#)  
   moving between databases, [10-20](#)  
 target standby database  
   for switchover, [9-3](#)  
 terminal destinations, [7-8](#)  
   configuring, [7-9](#)  
 terminating  
   network connection, [17-15](#)  
 throughput  
   on logical standby databases, [11-4](#)  
 time lag  
   delaying application of archived redo log files, [8-3](#), [17-7](#)  
   in standby database, [8-3](#)  
 TIME\_COMPUTED column, [9-4](#)  
 TIME\_COMPUTED column of the  
   V\$DATAGUARD\_STATS view, [9-4](#)  
 tnsnames.ora file  
   redo transport services tuning and, [A-11](#)  
   troubleshooting, [A-2](#), [A-5](#), [A-11](#), [G-8](#)  
 transaction size considerations  
   SQL Apply, [11-3](#)  
 Transparent Data Encryption  
   support by SQL Apply, [C-5](#)  
 transportable tablespaces  
   using with a physical standby database, [10-20](#)  
 triggers  
   handled on a logical standby database, [11-26](#)  
   role transitions, [9-8](#)  
 troubleshooting  
   if SQL Apply stops, [A-10](#)  
   last redo data was not transmitted, [A-4](#), [G-7](#)  
   listener.ora file, [A-2](#), [A-11](#)  
   logical standby database failures, [A-3](#)  
   SQL Apply, [A-10](#)  
   switchovers, [A-4](#)  
     ORA-01102 message, [A-5](#), [G-8](#)  
     roll back and start over, [A-6](#), [G-9](#)  
   tnsnames.ora file, [A-2](#), [A-5](#), [A-11](#), [G-8](#)  
 tuning  
   log apply rate for Redo Apply, [10-31](#)

## U

---

unique-index columns  
   logged with supplemental logging, [4-6](#), [11-4](#)  
 unrecoverable operations  
   backing up after, [15-12](#)  
 unsupported PL/SQL supplied packages, [C-11](#)

upgrading  
   Oracle Database software, [2-6](#), [13-1](#), [B-1](#)  
   setting the COMPATIBLE initialization parameter, [B-5](#)

## V

---

V\$ARCHIVE\_DEST view, [19-1](#), [A-2](#)  
   displaying information for all destinations, [19-1](#)  
 V\$ARCHIVE\_DEST\_STATUS view, [19-1](#)  
 V\$ARCHIVE\_GAP view, [19-2](#)  
 V\$ARCHIVED\_LOG view, [10-29](#), [19-2](#)  
 V\$DATABASE view, [19-2](#)  
   monitoring fast-start failover, [10-26](#)  
   SWITCHOVER\_STATUS column and, [A-4](#), [G-7](#)  
 V\$DATABASE\_INCARNATION view, [19-2](#)  
 V\$DATAFILE view, [15-12](#), [19-2](#)  
 V\$DATAGUARD\_CONFIG view, [19-2](#)  
   listing database names defined with LOG\_ARCHIVE\_CONFIG, [19-2](#)  
 V\$DATAGUARD\_STATS view, [9-4](#), [19-2](#)  
 V\$DATAGUARD\_STATUS view, [10-30](#)  
 V\$FS\_FAILOVER\_STATS view, [19-2](#)  
 V\$LOG view, [19-2](#)  
 V\$LOG\_HISTORY view, [10-29](#), [19-2](#)  
 V\$LOGFILE view, [19-2](#)  
 V\$LOGSTDBY\_PROCESS view, [11-9](#), [11-10](#), [11-15](#), [11-33](#), [11-34](#), [19-3](#)  
 V\$LOGSTDBY\_PROGRESS view, [11-10](#), [19-3](#)  
   RESTART\_SCN column, [11-4](#)  
 V\$LOGSTDBY\_STATE view, [9-4](#), [11-12](#), [11-14](#), [19-3](#)  
 V\$LOGSTDBY\_STATS view, [11-12](#), [19-3](#)  
   failover characteristics, [11-9](#)  
 V\$LOGSTDBY\_TRANSACTION view, [19-3](#)  
 V\$MANAGED\_STANDBY view, [10-29](#), [19-3](#)  
 V\$REDO\_DEST\_RESP\_HISTOGRAM  
   using to monitor synchronous redo transport response time, [7-13](#)  
 V\$REDO\_DEST\_RESP\_HISTOGRAM view, [19-3](#)  
 V\$STANDBY\_EVENT\_HISTOGRAM view, [19-3](#)  
 V\$STANDBY\_LOG view, [19-3](#)  
 VALID\_FOR attribute, [17-21](#)  
 verifying  
   logical standby databases, [4-12](#)  
   physical standby databases, [3-13](#)  
 versions  
   upgrading Oracle Database software, [13-1](#)  
 views  
   DBA\_LOGSTDBY\_EVENTS, [11-7](#), [19-1](#), [A-11](#)  
   DBA\_LOGSTDBY\_HISTORY, [19-1](#)

## views (continued)

DBA\_LOGSTDBY\_LOG, [11-8](#), [19-1](#)  
 DBA\_LOGSTDBY\_NOT\_UNIQUE, [19-1](#)  
 DBA\_LOGSTDBY\_PARAMETERS, [19-1](#)  
 DBA\_LOGSTDBY\_SKIP, [19-1](#)  
 DBA\_LOGSTDBY\_SKIP\_TRANSACTION,  
     [19-1](#)  
 DBA\_LOGSTDBY\_UNSUPPORTED, [19-1](#)  
 V\$ARCHIVE\_DEST, [19-1](#), [A-2](#)  
 V\$ARCHIVE\_DEST\_STATUS, [19-1](#)  
 V\$ARCHIVED\_GAP, [19-2](#)  
 V\$ARCHIVED\_LOG, [10-29](#), [19-2](#)  
 V\$DATABASE, [19-2](#)  
 V\$DATABASE\_INCARNATION, [19-2](#)  
 V\$DATAFILE, [15-12](#), [19-2](#)  
 V\$DATAGUARD\_CONFIG, [19-2](#)  
 V\$DATAGUARD\_STATS, [19-2](#)  
 V\$DATAGUARD\_STATUS, [10-30](#)  
 V\$FS\_FAILOVER\_STATS, [19-2](#)  
 V\$LOG, [19-2](#)

## views (continued)

V\$LOG\_HISTORY, [10-29](#), [19-2](#)  
 V\$LOGFILE, [19-2](#)  
 V\$LOGSTDBY\_PROCESS, [11-9](#), [19-3](#)  
 V\$LOGSTDBY\_PROGRESS, [11-10](#), [19-3](#)  
 V\$LOGSTDBY\_STATE, [11-12](#), [19-3](#)  
 V\$LOGSTDBY\_STATS, [11-12](#), [19-3](#)  
 V\$LOGSTDBY\_TRANSACTION, [19-3](#)  
 V\$MANAGED\_STANDBY, [10-29](#), [19-3](#)  
 V\$REDO\_DEST\_RESP\_HISTOGRAM, [19-3](#)  
 V\$STANDBY\_EVENT\_HISTOGRAM, [19-3](#)  
 V\$STANDBY\_LOG, [19-3](#)

---

**W**

## wait events

for redo transport services, [7-17](#)

WAITING FOR DICTIONARY LOGS state, [11-14](#)